

olivetti



d-Color MF220
d-Color MF280
d-Color MF360



COPY OPERATION



PUBLICATION ISSUED BY:

Olivetti S.p.A.

Gruppo Telecom Italia

Via Jervis, 77 - 10015 Ivrea (ITALY)

www.olivetti.com

Copyright © 2010,

Olivetti All rights reserved

The mark affixed to the product certifies that the product satisfies the basic quality requirements.



The manufacturer reserves the right to carry out modifications to the product described in this manual at any time and without any notice.



ENERGY STAR is a U.S. registered mark.

The ENERGY STAR program is an energy reduction plan introduced by the United States Environmental Protection Agency in response to environmental issues and for the purpose of advancing the development and utilization of more energy efficient office equipment.

Your attention is drawn to the following actions which could compromise the conformity attested to above, as well as the characteristics of the product:

- incorrect electrical power supply;
 - incorrect installation, incorrect or improper use or use not in compliance with the warnings provided in the User's Manual supplied with the product;
 - replacement of original components or accessories with others of a type not approved by the manufacturer, or performed by unauthorised personnel.
-

All rights reserved. No part of this material may be reproduced or transmitted in any form or by any means, electronic or mechanical, including photocopying, recording or by any information storage and retrieval system, without permission in writing from the Publisher.



Table of contents

1 Introduction

1.1	Welcome	1-3
1.1.1	User's guides	1-3
1.1.2	User's Guide	1-4
1.2	Conventions used in this manual	1-5
1.2.1	Symbols used in this manual	1-5
	To use this machine safely.....	1-5
	Procedural instruction.....	1-5
	Key symbols.....	1-6
1.2.2	Original and paper indications	1-6
	Original and paper sizes	1-6
	Original and paper indications	1-6

2 Part names and their functions

2.1	Options.....	2-3
2.2	Main Body.....	2-6
2.2.1	Outside of main body (Front)	2-6
2.2.2	Outside of the main body (rear)	2-8
2.2.3	Internal main unit.....	2-10
2.2.4	Control Panel	2-11
	Adjusting the angle of the Control Panel	2-12
2.2.5	Touch Panel	2-13
2.3	Option.....	2-15
2.3.1	Finisher FS-527/Saddle Stitcher SD-509/Punch Kit PK-517/Job Separator JS-603	2-15
2.3.2	Finisher FS-529.....	2-17
2.3.3	Job Separator JS-505.....	2-18

3 Using this machine

3.1	Turning on or off the machine	3-3
3.2	Basic copy operations.....	3-5
3.2.1	Placing originals.....	3-5
	Loading the original into the ADF	3-5
	Placing the original on the Original Glass	3-6
3.2.2	Basic copy operations	3-7
3.2.3	Copy operations using multiple functions	3-8
	Functions that cannot be combined	3-10

4 Control Panel Keys

	Control Panel and functions	4-3
4.1	About Start, Stop, and Interrupt	4-5
	Start	4-5
	Stop.....	4-5
	Interrupt.....	4-5
	Reset	4-5
4.2	About Copy, Fax/Scan, and User Box.....	4-6
	Copy.....	4-6
	Fax/Scan	4-6
	User Box	4-6
4.3	Utility/Counter	4-7
4.4	Mode Memory	4-8

4.5	Access	4-9
	Controlling access to the machine by user/account (user authentication/account track).....	4-9
	Using the machine during non-scheduled hours.....	4-11
4.6	Power Save	4-12
4.7	Accessibility	4-13
4.8	Enlarge Display	4-15
4.9	Guidance	4-16
4.10	C (Clear)	4-18
4.11	Proof Copy	4-19
	Printing one set to check the copy result (Proof Copy)	4-19
	Using a preview image to check the copy result (Advanced Preview)	4-20

5 Copy Function

5.1	[Basic]	5-4
5.1.1	[Color].....	5-5
5.1.2	[Paper].....	5-6
	Configuring a custom size	5-7
	Configuring wide paper.....	5-7
5.1.3	[Zoom].....	5-8
5.1.4	[Duplex/Combine]	5-9
5.1.5	[Finishing]	5-12
5.1.6	[Separate Scan].....	5-14
5.1.7	[Auto Rotate OFF]	5-15
5.2	[Original Setting]	5-16
	Copying mixed originals	5-17
	Copying Z-folded originals.....	5-18
5.3	[Quality/Density]	5-19
5.4	[Application]	5-22
5.4.1	[Sheet/Cover/Chapter Insert]	5-23
	[OHP Interleave]	5-23
	[Cover Sheet]	5-24
	[Insert Sheet]	5-25
	[Insert Image]	5-26
	[Chapters].....	5-27
	[Program Jobs].....	5-28
5.4.2	[Edit Color]	5-30
	[Neg./Pos. Reverse]	5-30
	[Mirror Image].....	5-31
	[Background Color]	5-32
	[Color Adjust]	5-33
5.4.3	[Book Copy/Repeat].....	5-35
	[Book Copy]	5-35
	[Image Repeat].....	5-37
	[Poster Mode].....	5-38
	[Booklet Original].....	5-39
5.4.4	[Page Margin]	5-40
5.4.5	[Image Adjust]	5-41
5.4.6	[Booklet]	5-43
5.4.7	[Erase]	5-44
	[Frame Erase]	5-44
	[Non-Image Area Erase].....	5-45
5.4.8	[Stamp/Composition]	5-46
	[Date/Time].....	5-46
	[Page Number]	5-47
	[Stamp].....	5-49
	[Copy Protect]	5-50
	[Copy Guard].....	5-51
	[Password Copy].....	5-52
	[Stamp Repeat]	5-53



	[Header/Footer].....	5-55
	[Watermark].....	5-56
	[Overlay].....	5-57
	[Registered Overlay].....	5-58
5.4.9	[Card Shot].....	5-60
5.4.10	[Save in User Box].....	5-61
5.5	Left panel display	5-62
5.5.1	[Job List].....	5-63
5.5.2	[Check Job].....	5-65

6 [User Settings]

6.1	[System Settings]	6-4
6.2	[Custom Display Settings]	6-7
6.3	[Copier Settings]	6-9
6.4	[Scan/Fax Settings]	6-11
6.5	[Printer Settings]	6-12
6.6	[Change Password]	6-13
6.7	[Change E-Mail Address]	6-14
6.8	[Change Icon]	6-15
6.9	[Register Authentication Information]	6-16
6.10	[Cellular Phone/PDA Setting]	6-18

7 [Administrator Settings]

7.1	[System Settings]	7-4
7.1.1	[Power Save Settings].....	7-4
7.1.2	[Output Settings].....	7-5
7.1.3	[Date/Time Settings].....	7-6
7.1.4	[Daylight Saving Time].....	7-6
7.1.5	[Weekly Timer Settings].....	7-7
7.1.6	[Restrict User Access].....	7-8
7.1.7	[Expert Adjustment].....	7-10
	[Leading Edge Adjustment].....	7-13
	[Centering].....	7-13
	[Media Adjustment].....	7-14
	[Center Staple Position].....	7-14
	[Half-Fold Position].....	7-15
	[Punch Horizontal Position Adjustment].....	7-15
	[Punch Regist Loop Size Adjustment].....	7-16
	[Paper Alignment Plate Settings].....	7-16
	[Color Registration Adjust].....	7-16
	[Gradation Adjustment].....	7-17
7.1.8	[List/Counter].....	7-18
7.1.9	[Reset Settings].....	7-19
7.1.10	[User Box Settings].....	7-20
7.1.11	[Standard Size Setting].....	7-20
7.1.12	[Stamp Settings].....	7-21
7.1.13	[Blank Page Print Settings].....	7-22
7.1.14	[Skip Job Operation Settings].....	7-22
7.1.15	[Default Bypass Paper Type Setting].....	7-23
7.1.16	[Page Number Print Position].....	7-24
7.1.17	[Advanced Preview Setting].....	7-24
7.2	[Administrator/Machine Settings]	7-25
7.3	[One-Touch/User Box Registration]	7-26
7.4	[User Authentication/Account Track]	7-27
7.4.1	[General Settings].....	7-27
7.4.2	[User Authentication Settings].....	7-30

7.4.3	[Account Track Settings].....	7-33
7.4.4	[Print without Authentication].....	7-35
7.4.5	[Print Counter List]	7-35
7.4.6	[External Server Settings].....	7-36
7.4.7	[Limiting Access to Destinations].....	7-36
7.4.8	[Authentication Device Settings].....	7-37
7.4.9	[User/Account Common Setting].....	7-38
7.4.10	[Scan to Home Settings]	7-38
7.4.11	[Scan to Authorized Folder Settings]	7-38
7.5	[Network Settings]	7-39
7.6	[Copier Settings]	7-40
7.7	[Printer Settings]	7-42
7.8	[Fax Settings].....	7-43
7.9	[System Connection]	7-44
7.10	[Security Settings].....	7-46
7.10.1	[Administrator Password].....	7-46
7.10.2	[User Box Administrator Setting]	7-46
7.10.3	[Administrator Security Levels]	7-47
7.10.4	[Security Details]	7-48
7.10.5	[Enhanced Security Mode].....	7-51
	Required settings	7-51
	Settings to forcibly changed	7-52
7.10.6	[HDD Settings]	7-53
7.10.7	[Function Management Settings]	7-54
7.10.8	[Stamp Settings].....	7-55
7.10.9	[Driver Password Encryption Setting]	7-55
7.11	[License Settings]	7-56
7.12	[OpenAPI Authentication Management Setting].....	7-57

8 Maintenance

8.1	Paper	8-3
8.1.1	Checking the paper.....	8-3
	Replenishment message.....	8-3
	Precautions regarding the use of paper	8-3
	Paper storage.....	8-3
8.1.2	Loading paper	8-4
	Loading paper in Tray 1, Tray 2, Tray 3, or Tray 4.....	8-4
	Loading paper in LCT	8-5
	Loading paper into the Bypass Tray	8-6
8.2	Consumables.....	8-8
8.2.1	Checking consumables	8-8
	Replacement message	8-8
	Checking consumables status.....	8-10
	Viewing counters.....	8-11
	Checking the total number of pages printed	8-13
8.3	Cleaning procedure	8-14
	Slit Scan Glass.....	8-14
	Original Glass, Control Panel, Paper Take-Up Roller	8-14
	Housing, Original Pad	8-15

9 Troubleshooting

9.1	When a problem is detected (call a service representative).....	9-3
	Problems that cannot be corrected by the user	9-3
9.2	Troubleshooting table.....	9-5
	Simple troubleshooting	9-5
	Main messages and their remedies	9-9
	Icons that appear in the touch-panel screen.....	9-12



9.3	If print quality is deteriorated.....	9-13
	Cleaning the Electrostatic Charger Wire.....	9-13
	Cleaning the Printhead.....	9-14
10	Authentication unit (biometric type)	
10.1	Using an authentication unit (biometric type)	10-3
10.1.1	Configuring this machine	10-5
10.1.2	Registering a user	10-7
	Registering a user using the Control Panel of this machine.....	10-7
	Registering a user using Data Administrator	10-8
	Checking the version of the installed Data Administrator.....	10-9
	Setup.....	10-9
	User registration.....	10-13
10.1.3	Logging in to this machine.....	10-19
	When [1-to-many authentication] has been specified	10-19
	When [1-to-1 authentication] has been specified	10-20
11	Authentication unit (IC card type)	
11.1	Using authentication unit (IC card type)	11-3
11.1.1	Configuring this machine	11-3
11.1.2	Registering a user	11-5
	Registering a user using the Control Panel of this machine.....	11-5
	Registering a user using Data Administrator	11-7
	Checking the version of the installed Data Administrator.....	11-7
	Setup.....	11-8
	User registration.....	11-12
11.1.3	Logging in to this machine.....	11-16
	When [Card Authentication] is enabled.....	11-16
	When [Card Authentication + Password] is enabled	11-17
12	Specifications	
12.1	Paper	12-3
	Paper types and paper capacities	12-3
12.2	Machine specifications.....	12-5
	d-Color MF360/280/220	12-5
	Auto Duplex Unit.....	12-7
12.3	Options.....	12-8
	Reverse Automatic Document Feeder DF-617	12-8
	Paper Feed Cabinet PC-107.....	12-8
	Paper Feed Cabinet PC-207.....	12-9
	Paper Feed Cabinet PC-408.....	12-9
	Finisher FS-527	12-10
	Saddle Stitcher SD-509	12-12
	Punch Kit PK-517	12-12
	Separator JS-603.....	12-13
	Finisher FS-529.....	12-14
	Job Separator JS-505.....	12-15
	Authentication Unit (biometric type) AU-101	12-15
	Authentication Unit (biometric type) AU-102	12-16
	Authentication Unit (IC card type) AU-201.....	12-17
13	Appendix	
13.1	Colors.....	13-3
	[Hue], [Brightness], and [Saturation]	13-3
	[Red], [Green], and [Blue]	13-5
13.2	Image quality	13-6
	[Contrast], [Copy Density], and [Sharpness].....	13-6
	[Color Balance] (CMYK)	13-7



13.3	Glossary	13-8
------	----------------	------

14 Index

14.1	Index by item	14-3
14.2	Index by button.....	14-7



Introduction

1 Introduction

1.1 Welcome

Thank you for purchasing this machine.

This User's Guide describes the functions, operating instructions, precautions for correct operation, and simple troubleshooting guidelines of this machine. In order to obtain maximum performance from this product and use it effectively, please read this User's Guide as necessary.

1.1.1 User's guides

Printed manual	Overview
[Quick Guide Copy/Print/Fax/Scan/Box Operations]	<p>This manual describes operating procedures and the functions that are most frequently used in order to enable you to begin using this machine immediately. This manual also contains notes and precautions that should be followed to ensure safe usage of this machine.</p> <p>Please be sure to read this manual before using this machine.</p> <p>This manual describes details on trademarks and copyrights.</p> <ul style="list-style-type: none"> • Trademarks and copyrights
User's guide DVD manuals	Overview
[User's Guide Copy Operations]	<p>This manual describes details on copy mode operations and the settings of this machine.</p> <ul style="list-style-type: none"> • Specifications of originals and copy paper • Copy function • Maintaining this machine • Troubleshooting
[User's Guide Enlarge Display Operations]	<p>This manual describes details on operating procedures of the enlarge display mode.</p> <ul style="list-style-type: none"> • Copy function • Scanning function • G3 fax function • Network fax function
[User's Guide Print Operations]	<p>This manual describes details on printer functions.</p> <ul style="list-style-type: none"> • Printer function • Setting the printer driver
[User's Guide Box Operations]	<p>This manual describes details on the boxed functions using the hard disk.</p> <ul style="list-style-type: none"> • Saving data in user boxes • Retrieving data from user boxes • Transferring and printing data from user boxes
[User's Guide Network Scan/Fax/Network Fax Operations]	<p>This manual describes details on transmitting scanned data.</p> <ul style="list-style-type: none"> • E-mail TX, FTP TX, SMB TX, Save in User Box, WebDAV TX, Web Services • G3 fax • IP Address Fax, Internet Fax
[User's Guide Fax Driver Operations]	<p>This manual describes details on the fax driver function that transmits faxes directly from a computer.</p> <ul style="list-style-type: none"> • PC-FAX
[User's Guide Network Administrator]	<p>This manual describes details on setting methods for each function using the network connection.</p> <ul style="list-style-type: none"> • Network settings • Settings using Connection

User's guide DVD manuals	Overview
[User's Guide Advanced Function Operations]	This manual describes details on functions that become available by registering the optional license kit and by connecting to an application. <ul style="list-style-type: none">• Web browser function• Image panel• PDF Processing Function• Searchable PDF• My panel and My address functions

1.1.2 User's Guide

This User's Guide is intended for users ranging from those using this machine for the first time to administrators.

It describes basic operations, functions that enable more convenient operations, maintenance procedures, simple troubleshooting operations, and various setting methods of this machine.

Note that basic technical knowledge about the product is required to enable users to perform maintenance work or troubleshooting operations. Limit your maintenance and troubleshooting operations to the areas explained in this manual.

Should you experience any problems, please contact your service representative.

1.2 Conventions used in this manual

1.2.1 Symbols used in this manual

Symbols are used in this manual to express various types of information.

The following describes each symbol related to correct and safe usage of this machine.

To use this machine safely

⚠ WARNING

- This symbol indicates that a failure to heed the instructions may lead to death or serious injury.

⚠ CAUTION

- This symbol indicates that negligence of the instructions may lead to mishandling that may cause injury or property damage.

NOTICE

This symbol indicates a risk that may result in damage to this machine or originals. Follow the instructions to avoid property damage.

Procedural instruction

- ✓ This check mark indicates an option that is required in order to use conditions or functions that are prerequisite for a procedure.

1 This format number "1" represents the first step.

2 This format number represents the order of serial steps.

- This symbol indicates a supplementary explanation of a procedural instruction.

The operation procedures are described using illustrations.

- This symbol indicates transition of the control panel to access a desired menu item.

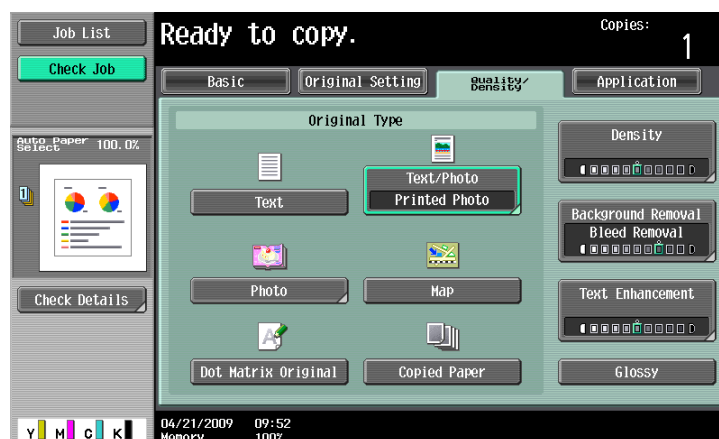

The symbol indicates a desired page.



Reference

This symbol indicates a reference.

View the reference as required.

Key symbols

[]

Key names on the touch panel or computer screen, or a name of user's guide are indicated by these brackets.

Bold text

Key names on the control panel, part names, product names and option names are indicated in bold text.

1.2.2 Original and paper indications

Original and paper sizes

The following explains the indication for originals and paper described in this manual.

When indicating the original or paper size, the Y side represents the width and the X side the length.

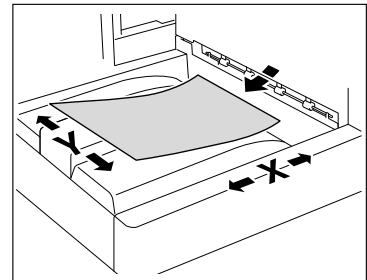

Original and paper indications

☐ indicates the paper size with the length (X) being longer than the width (Y).

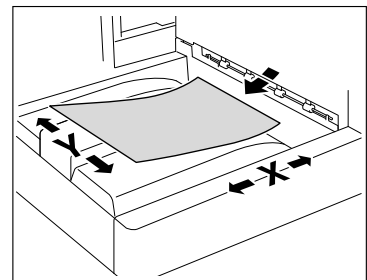

☐ indicates the paper size with the length (X) being shorter than the width (Y).

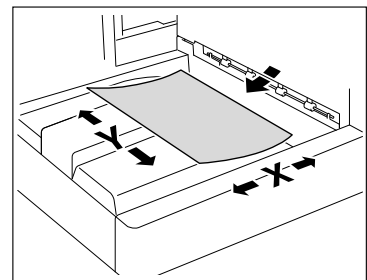



Part names and their functions

2 Part names and their functions

2.1 Options

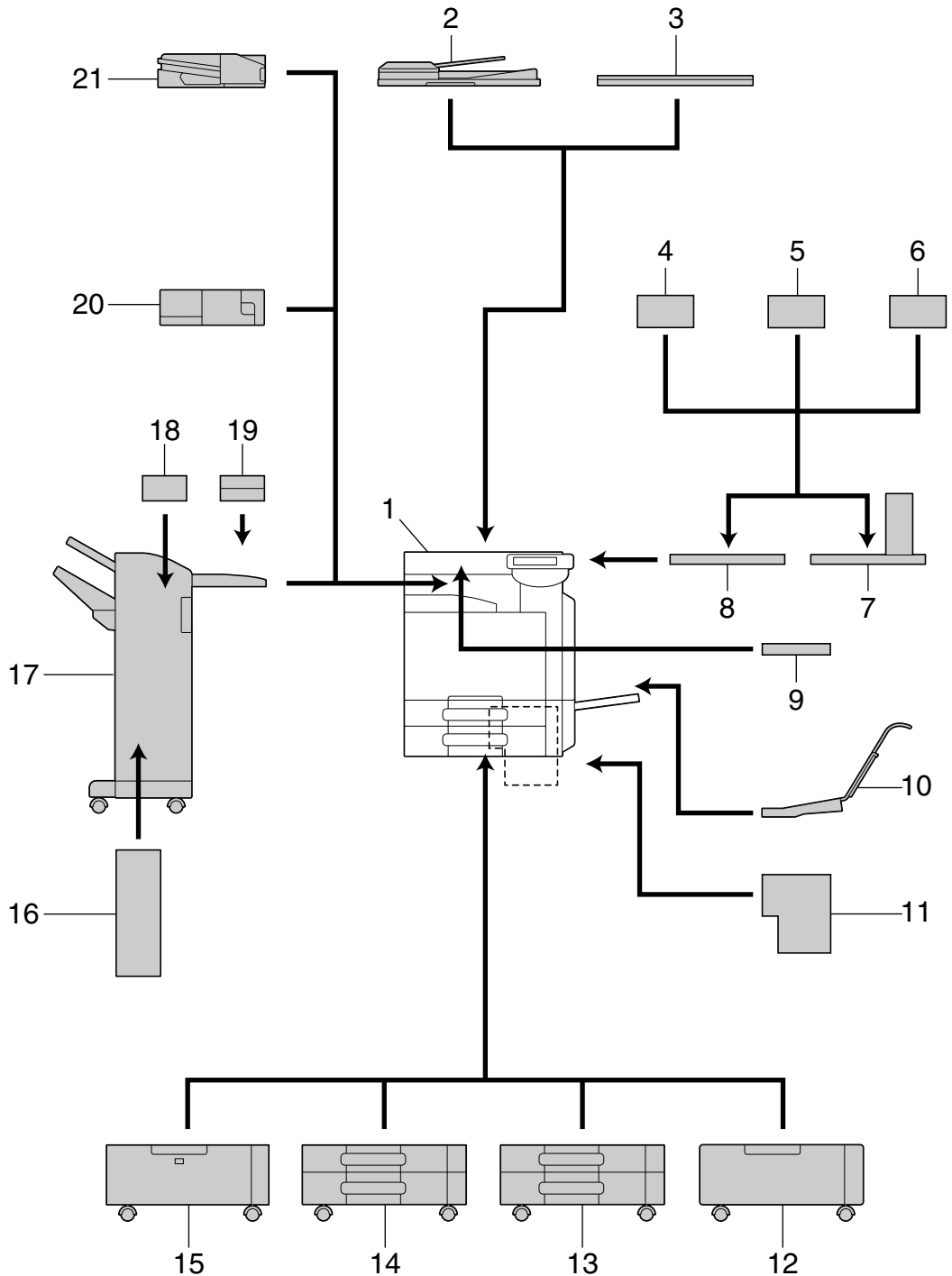

No.	Name	Description
1	Main unit	The original is scanned by the scanner section, and the scanned image is printed by the printer section. Referred to as the "machine", the "main unit", or the "d-Color MF360/280/220" throughout the manual.

No.	Name	Description
2	Reverse Automatic Document Feeder DF-617	Automatically feeds and scans originals by page. This unit automatically reverses and scans 2-sided originals. This unit is hereinafter referred to as the ADF through the manual.
3	Original Cover OC-509	Fixes the loaded originals. This unit is hereinafter referred to as the Original Cover through the manual.
4	Authentication Unit (biometric type) AU-101	Performs user authentication by scanning vein patterns in the finger. To install the Authentication Unit (biometric type) AU-101 or Authentication Unit (biometric type) AU-102 , the Working Table WT-507 or Working Table WT-506 is required.
5	Authentication Unit (biometric type) AU-102	This unit is hereinafter referred to as the Authentication Unit through the manual.
6	Authentication Unit (IC card type) AU-201	Performs user authentication by scanning information recorded on the IC card. To install the Authentication Unit (IC card type) AU-201 , the Working Table WT-507 or Working Table WT-506 is required. This unit is hereinafter referred to as the Authentication Unit through the manual.
7	Working Table WT-507	Allows you to move the Control Panel to a different location. This is also used when the Authentication Unit is installed. <ul style="list-style-type: none"> This option may not be available depending on the sales area.
8	Working Table WT-506	Provides an area to temporarily place an original or other materials. This is also used when the authentication unit is installed.
9	Keyboard Holder KH-101	Install this holder to use a compact keyboard. For details on compact keyboards, contact your service representative.
10	Mount Kit MK-713	Used for banner printing. <ul style="list-style-type: none"> This option may not be available depending on the sales area.
11	Image Controller IC-412 v1.1	This unit is an external Image Controller to be installed in d-Color MF360 or d-Color MF280 . Allows you to use this machine as a network-enabled color printer. To install the Image Controller IC-412 v1.1 , the Desk DK-507 , Paper Feed Cabinet PC-408 , Paper Feed Cabinet PC-107 , or Paper Feed Cabinet PC-207 must be installed onto this machine.
12	Desk DK-507	By using the Desk , you can install this machine on the floor. This unit is hereinafter referred to as the Desk through the manual. <ul style="list-style-type: none"> This option may not be available depending on the sales area.
13	Paper Feed Cabinet PC-107	Allows you to load up to 500 sheets in the top tray and use the bottom tray as a storage box. This unit is hereinafter referred to as the Single Paper Feed Cabinet through the manual.
14	Paper Feed Cabinet PC-207	Allows you to load up to 500 sheets respectively in the top and bottom trays. This unit is hereinafter referred to as the Double Paper Feed Cabinet through the manual.
15	Paper Feed Cabinet PC-408	Allows you to load up to 2500 sheets. This unit is hereinafter referred to as the LCT through the manual.

No.	Name	Description
16	Saddle Stitcher SD-509	Install this unit onto the Finisher FS-527 to allow Fold/Bind. Referred to as the Saddle Stitcher throughout the manual.
17	Finisher FS-527	Sorts, groups and staples printed paper before feeding out. To install the Finisher FS-527 , the Desk DK-507 , Paper Feed Cabinet PC-408 , Paper Feed Cabinet PC-107 , or Paper Feed Cabinet PC-207 must be installed onto this machine.
18	Punch Kit PK-517	Install this unit onto the Finisher FS-527 to enable punching holes.
19	Job Separator JS-603	Install this unit onto the Finisher FS-527 . Collects printed pages.
20	Finisher FS-529	Install this unit onto the output tray of the main unit to sort, group or staple printed paper before feeding out.
21	Job Separator JS-505	Install this unit onto the output tray of the main unit to offset the printed papers. This unit is hereinafter referred to as the Job Separator through the manual.
<i>The following options are built inside this machine and are not shown in the figure above.</i>		
22	Fax Kit FK-502	Allows this machine to function as a fax machine. Alternatively, it allows more telephone lines to be connected.
23	Stamp Unit SP-501	Applies a stamp to originals that have been scanned.
24	Spare TX Marker Stamp 2	A replacement stamp for the Stamp Unit SP-501 .
25	Mount Kit MK-720	Attach this kit to install an optional fax kit.
26	Local Interface Kit EK-604	Install this holder to use a compact keyboard. For details on compact keyboards, contact your service representative.
27	Local Interface Kit EK-605	Install this kit when using the connection function with a compact keyboard or Bluetooth-compatible cellular phone or PDA. A receiving device for Bluetooth communication is built in to this kit.
28	Video Interface Kit VI-505	This kit is required for installing the Image Controller IC-412 v1.1 onto d-Color MF360 or d-Color MF280 .
29	Security Kit SC-507	Enables the copy guard or password copy function. This kit is used to prevent unauthorized copying.
30	i-Option LK-101 v2	Enables a Web browser and the Image Panel function to be used on the control panel.
31	i-Option LK-102	Enables PDF document encryption with a digital ID, attaching of a digital signature, and property settings when distributing a PDF document using the scan or User Box function.
32	i-Option LK-105	Provides the searchable PDF function.
33	Upgrade Kit UK-203	Required when using Web browser, image panel, PDF processing, searchable PDF, My panel, or My address function. If necessary, you can increase the number of languages, which can be displayed in the Control Panel of this machine, up to nine.

2.2 Main Body

2.2.1 Outside of main body (Front)

The illustration above shows the main unit with an optional **Original Cover OC-509** and **Paper Feed Cabinet PC-408**.

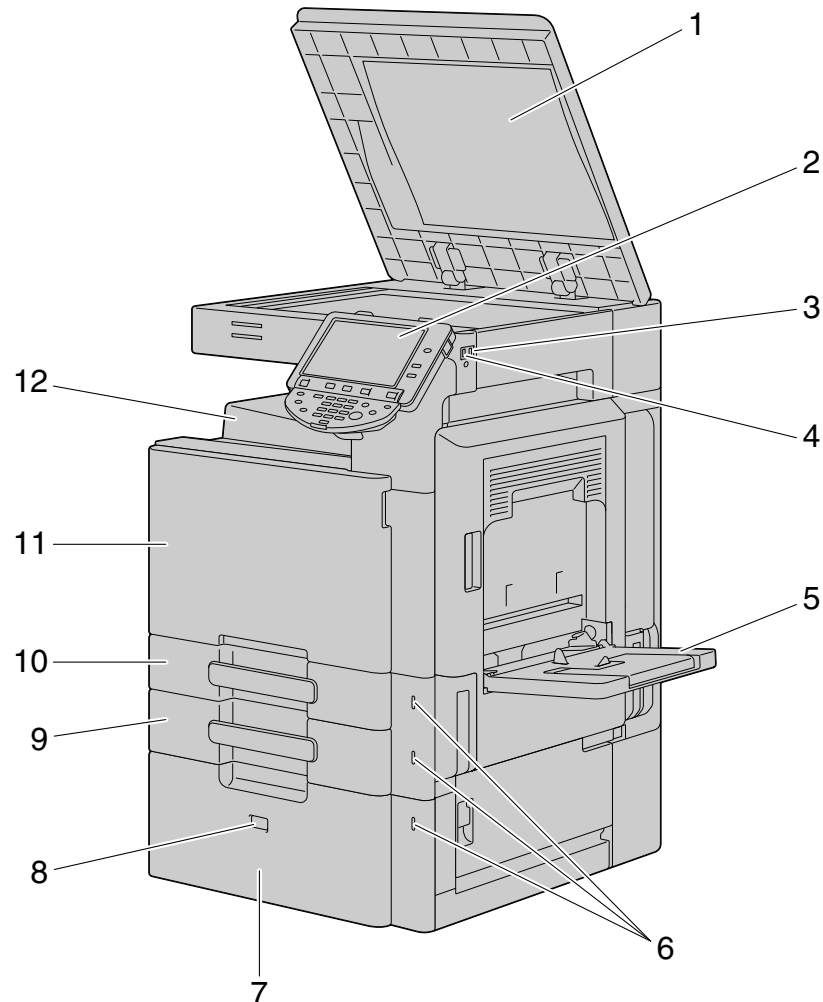

No.	Name
1	Original Pad
2	Control Panel
3	USB Port (Type A) USB2.0/1.1
4	USB Port (Type A) USB2.0/1.1 (For compact keyboard)
5	Bypass Tray
6	Paper-Empty Indicator
7	LCT
8	Tray Release Button
9	Tray 2
10	Tray 1
11	Front Door

No.	Name
12	Output Tray

The illustration above shows the main unit with an optional **Reverse Automatic Document Feeder DF-617** and **Paper Feed Cabinet PC-207**.

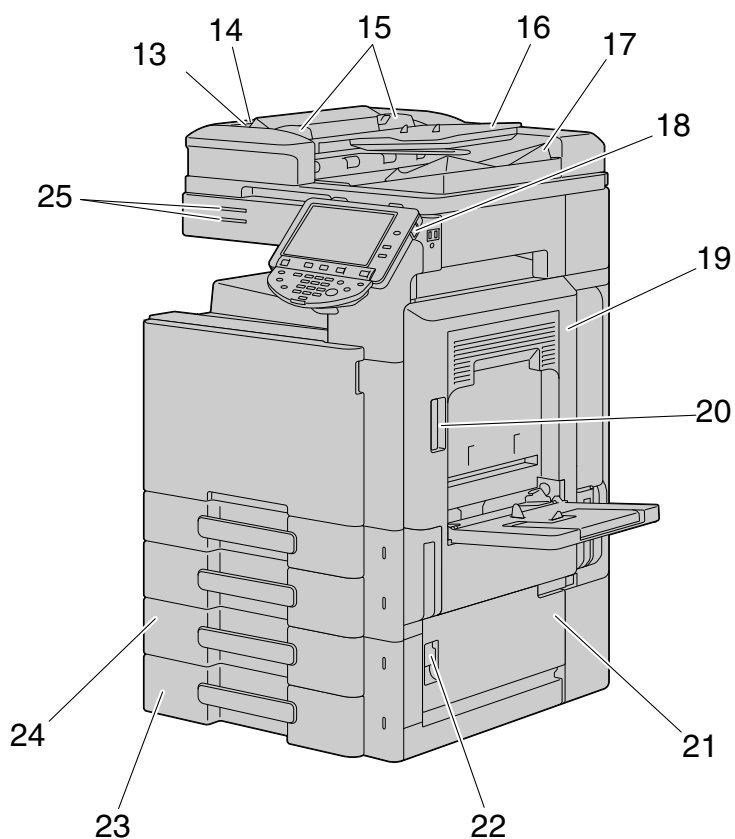

No.	Name
13	Left Cover Release Lever
14	Left Cover
15	Lateral Guide
16	Original Tray
17	Original Output Tray
18	Sub Power Switch
19	Top Right Door
20	Top Right Door Release Lever
21	Bottom Right Door
22	Bottom Right Door Release Lever
23	Tray 4/Storage Box

No.	Name
24	Tray 3
25	Status Indicator

2.2.2 Outside of the main body (rear)

The illustration above shows the main unit with an optional **Reverse Automatic Document Feeder DF-617**, **Paper Feed Cabinet PC-207**, and **Fax Kit FK-502**.

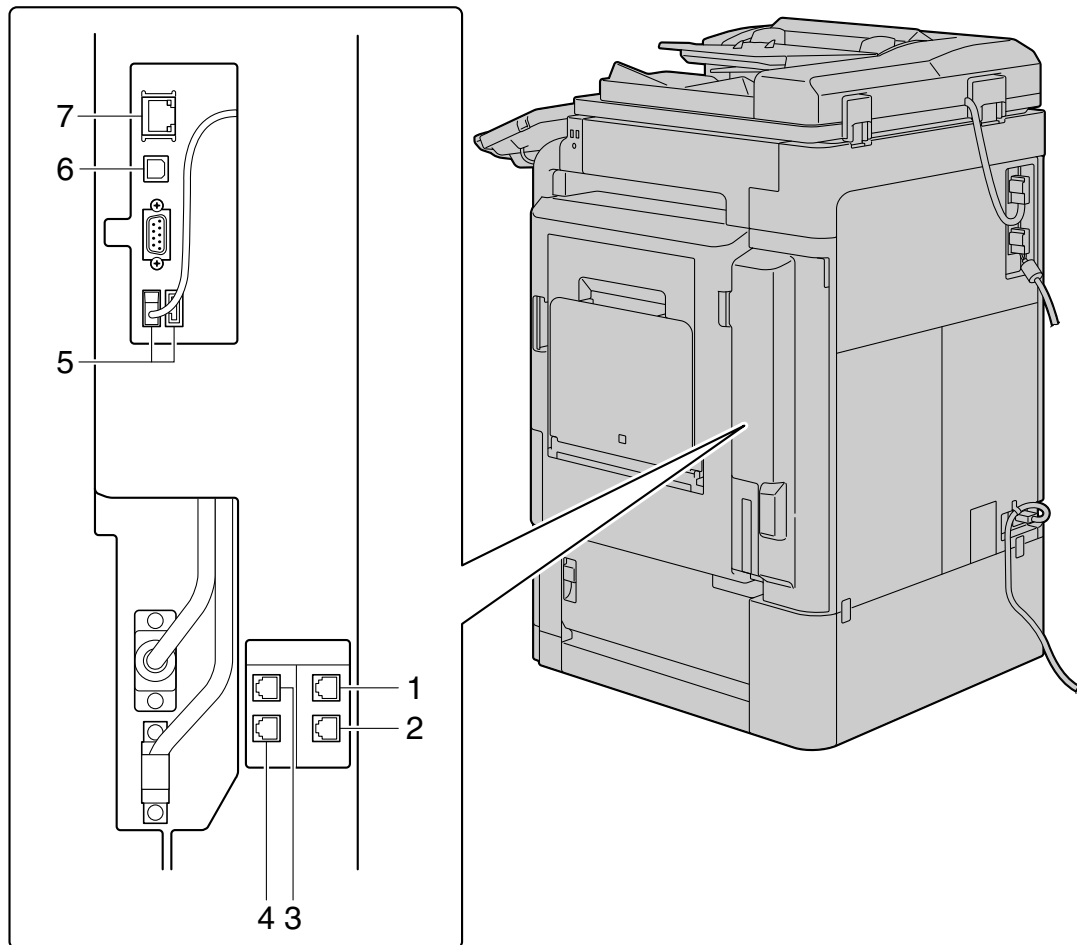

The illustration above shows the main unit with an optional **Reverse Automatic Document Feeder DF-617** and **Paper Feed Cabinet PC-207**.

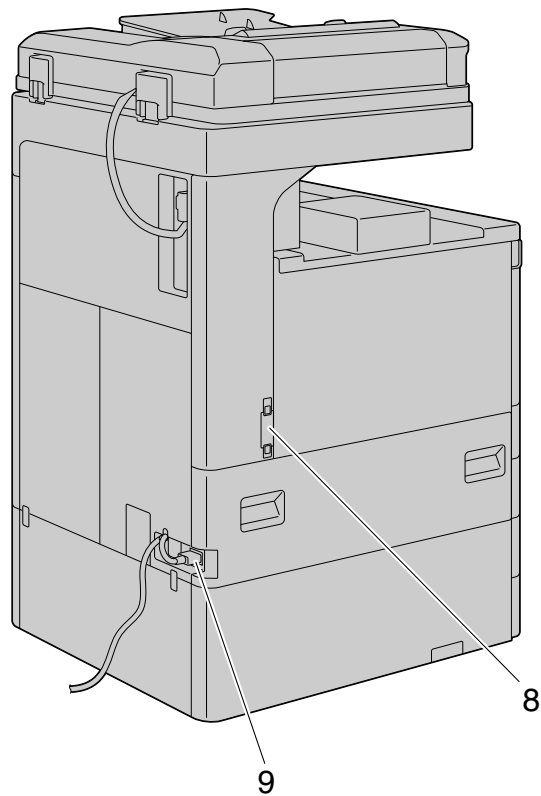

No.	Name
1	Jack for connecting a telephone (TEL PORT2)
2	Telephone Jack 2 (LINE PORT2)
3	Jack for connecting a telephone (TEL PORT1)
4	Telephone Jack 1 (LINE PORT1)
5	USB Port (Type A) USB2.0/1.1
6	USB Port (Type B) USB2.0/1.1
7	Network Connector (10Base-T/100Base-TX/1000Base-T)
8	Ozone Filter
9	Power Code

2.2.3 Internal main unit

The illustration above shows the main unit with an optional **Reverse Automatic Document Feeder DF-617** and **Paper Feed Cabinet PC-207**.

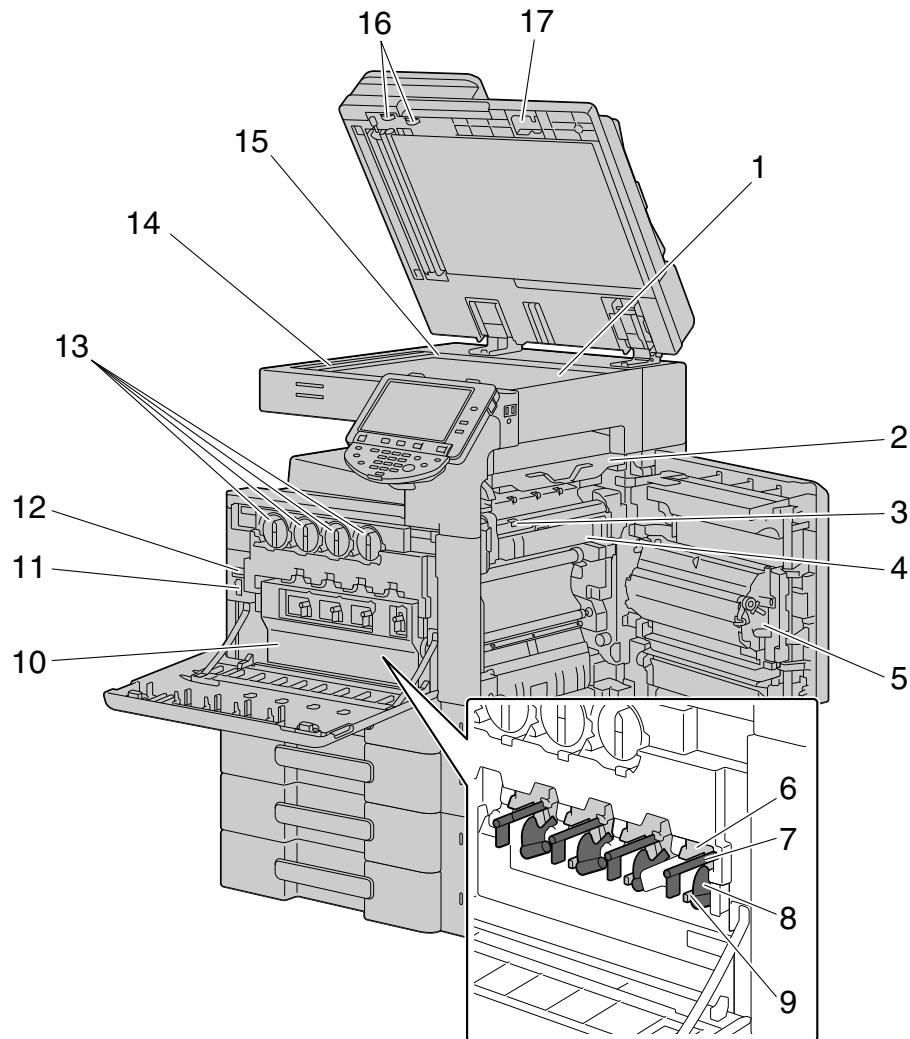

No.	Name
1	Original Glass
2	Fusing Unit Top Cover
3	Fusing Unit Cover Lever
4	Fusing Unit
5	Auto Duplex Unit
6	Drum Unit
7	Charger Cleaner
8	Lock Release Tab
9	Printhead Cleaner
10	Waste Toner Box
11	Main Power Switch
12	Total Counter
13	Toner Cartridge
14	Slit Scan Glass
15	Original Scale

No.	Name
16	Jam Removal Dial
17	Slit Glass Cleaner

2.2.4 Control Panel

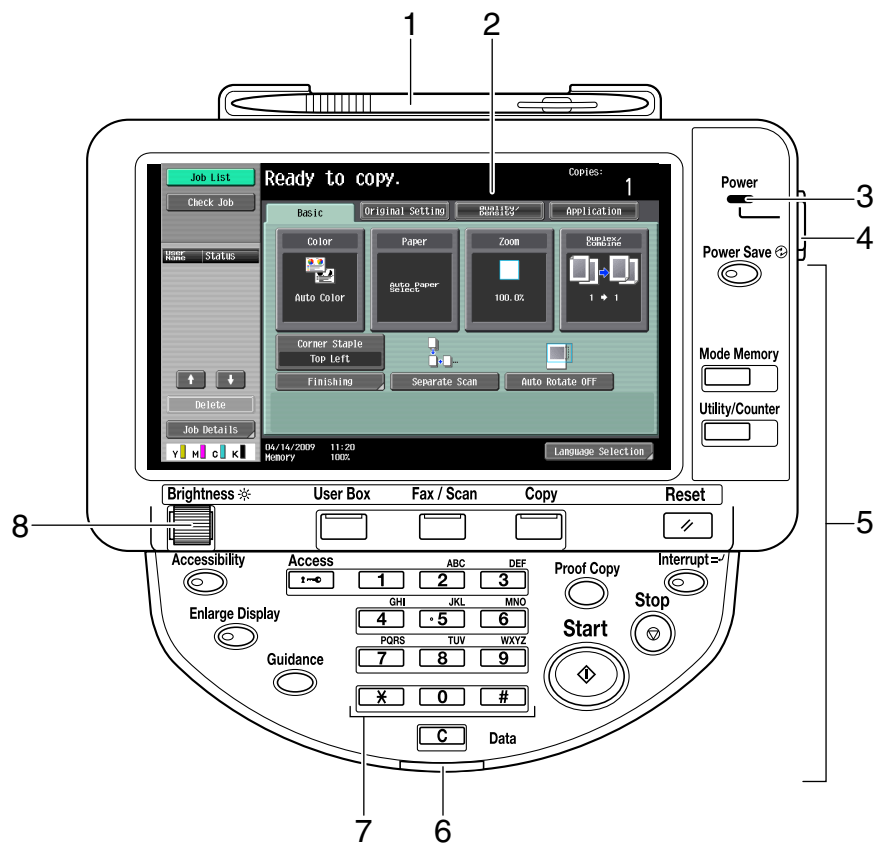

No.	Name
1	Stylus Pen
2	Touch Panel
3	Power Indicator
4	Sub Power Switch
5	Function key
6	Data Indicator
7	Keypad
8	Brightness adjustment dial

Adjusting the angle of the Control Panel

You can adjust the angle of the **Control Panel** of this machine among three levels. You can also tilt the **Control Panel** to the left. Set it to your desired angle.

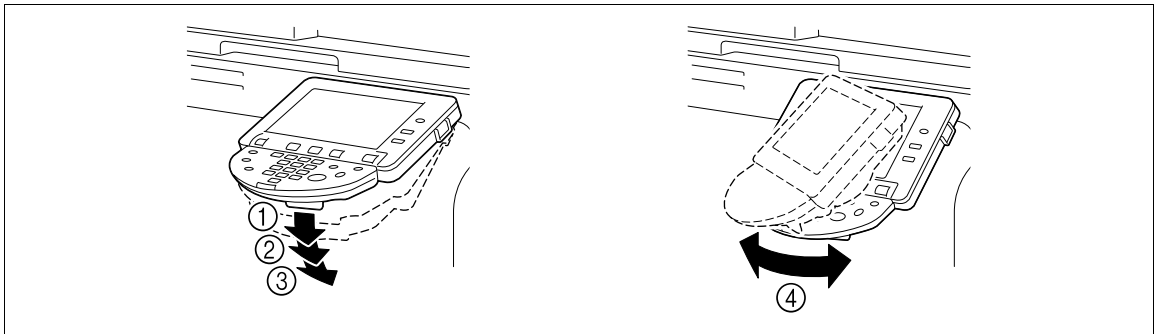

NOTICE

When tilting the **Control Panel**, do not grab the **Touch Panel**.

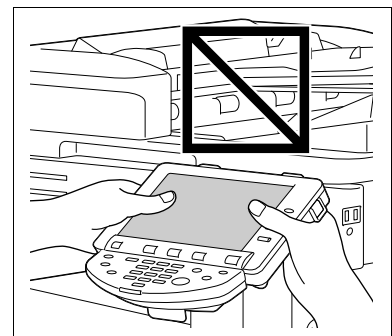

- 1 Pull the **Control Panel Release Lever** toward you, and then pull the **Control Panel** up or down.
You can tilt the angle of the **Control Panel** to one of the three positions.

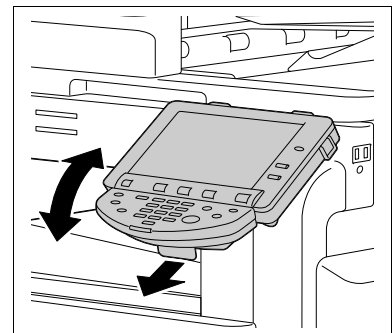

- 2 To tilt the **Control Panel** to the left or right, hold the bottom of the **Control Panel**, and then tilt the panel to the left or right.

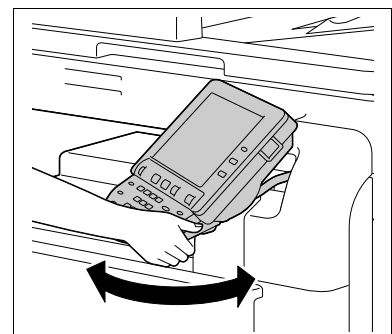

2.2.5 Touch Panel

When the machine has been turned on and is ready to begin the copy operation, the basic settings screen appears. To activate a function or to select a setting, lightly press the desired button appearing in the screen.

The basic settings screen can be switched between the Basic tab and Quick Copy tab. The arrangement of the buttons and screens differ with the Basic tab and Quick Copy tab; however, the functions that can be set are the same. This manual describes procedures for configuring settings from the Basic tab. The Quick Copy tab displays the setting items of the Basic tab on one screen, which is useful for configuring multiple settings.

NOTICE

*Do not apply excessive pressure on the **Touch Panel**. Such impact may leave a flaw on the panel, inviting damage to the **Touch Panel**. When operating in the **Touch Panel**, never press down on the touch panel with force or with a pointed object such as a mechanical pencil.*

Basic tab

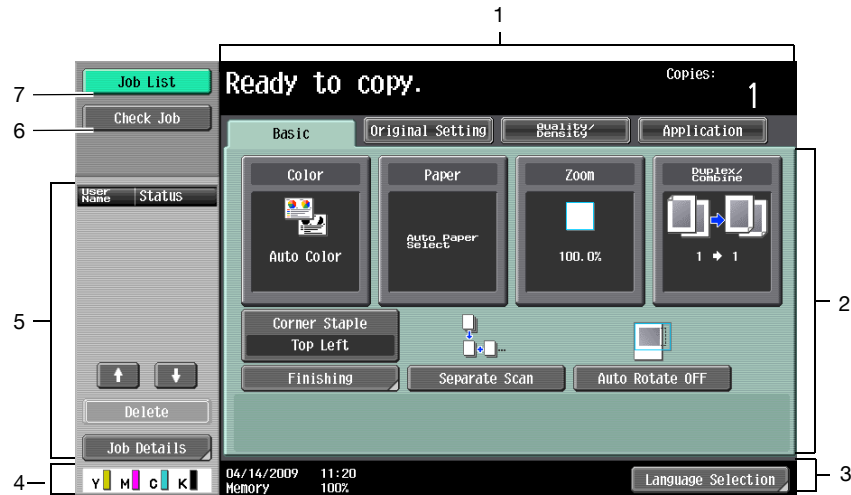

Quick Copy tab

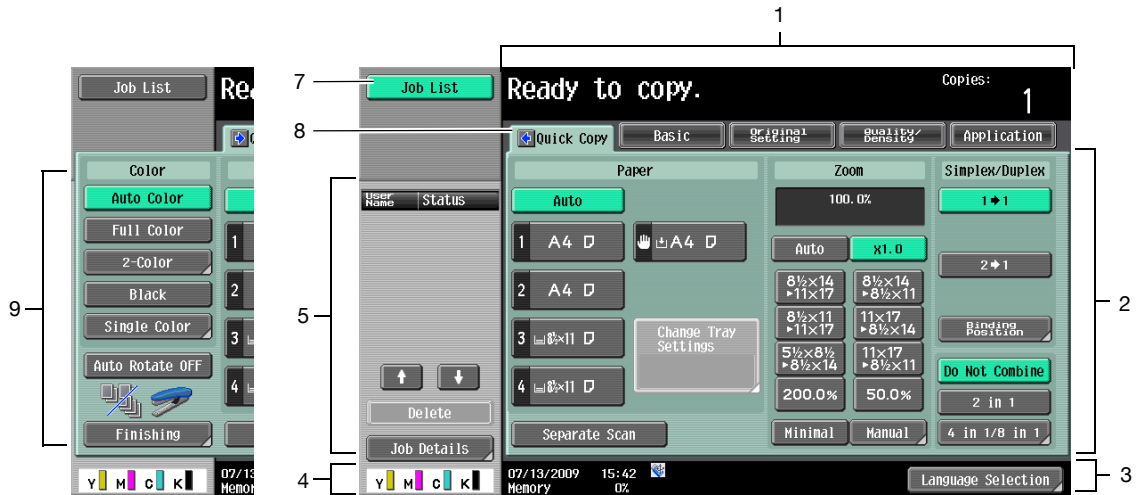

No.	Name
1	Message display area
2	Functions/settings display area
3	Icon/shortcut key display area
4	Toner supply indicators
5	Left panel
6	Check Job
7	Job List
8	Copier setting button (arrow)
9	Color settings

**Reference**

To switch the basic settings screen:

Press **Utility/Counter**▶▶[User Settings]▶▶[Custom Display Settings]▶▶[Copier Settings]▶▶[Default Tab].

To configure color selection settings for buttons and tabs:

Press **Utility/Counter**▶▶[User Settings]▶▶[Custom Display Settings]▶▶[Color Selection Settings].

2.3 Option

2.3.1 Finisher FS-527/Saddle Stitcher SD-509/Punch Kit PK-517/Job Separator JS-603

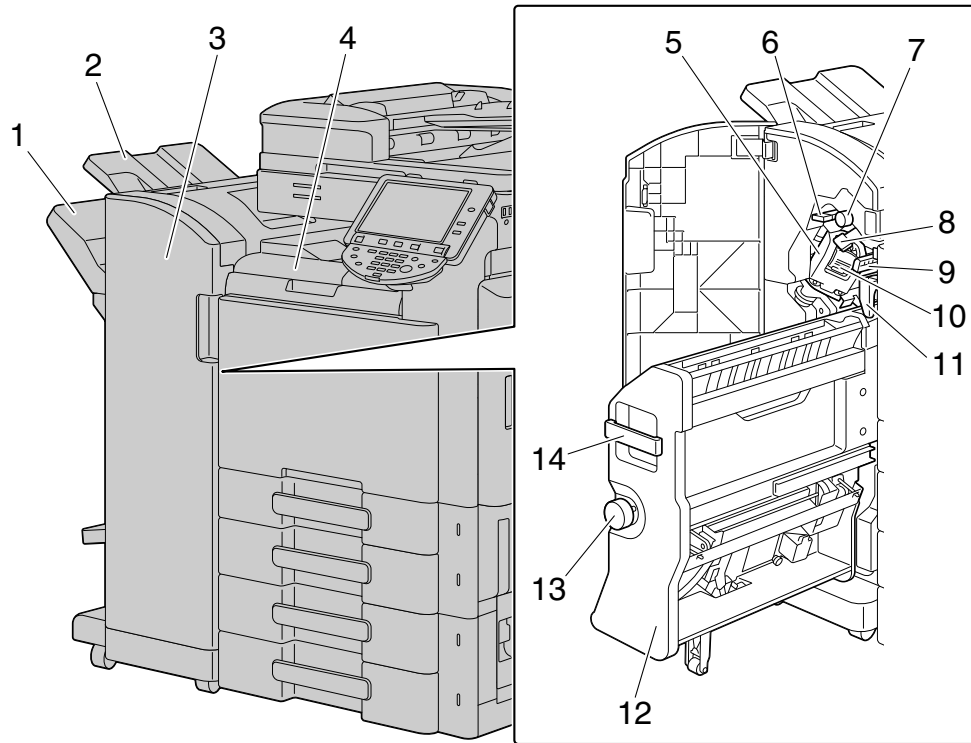

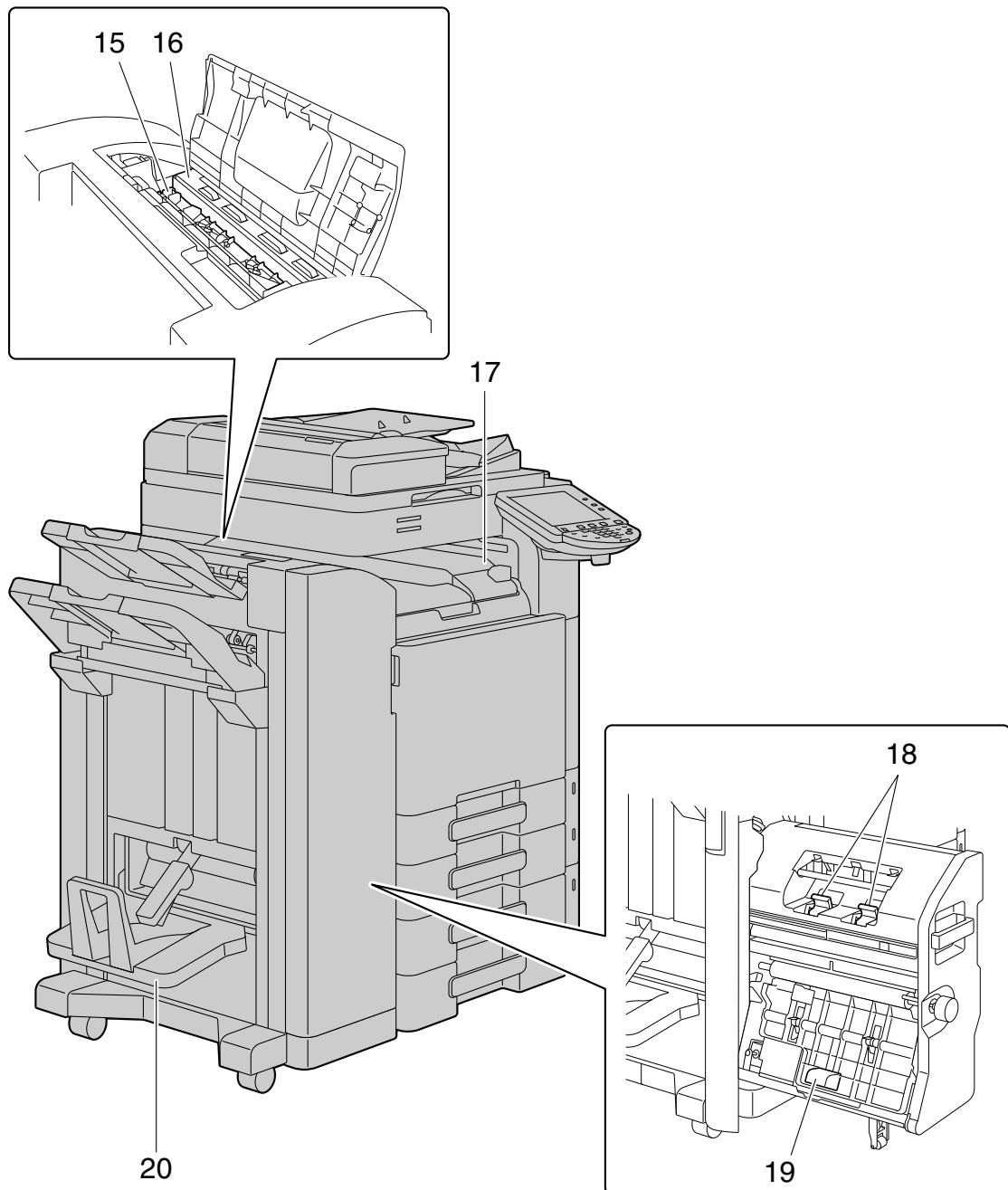

No.	Name
1	Output Tray 2
2	Output Tray 1
3	Front Door
4	Horizontal Transport Unit Cover
5	Stapler
6	Guide Lever [FN3]
7	Jam Removal Dial [FN2]
8	Guide Lever [FN1]
9	Guide Lever [FN4]
10	Staple Holder
11	Punch Scrap Box

No.	Name
12	Saddle Stitcher
13	Jam Removal Dial [FN6]
14	Handle [FN5]
15	Transport Unit
16	Punch Kit
17	Job Separator
18	Staple Cartridge
19	Handle [FN7]
20	Folding Output Tray

2.3.2 Finisher FS-529

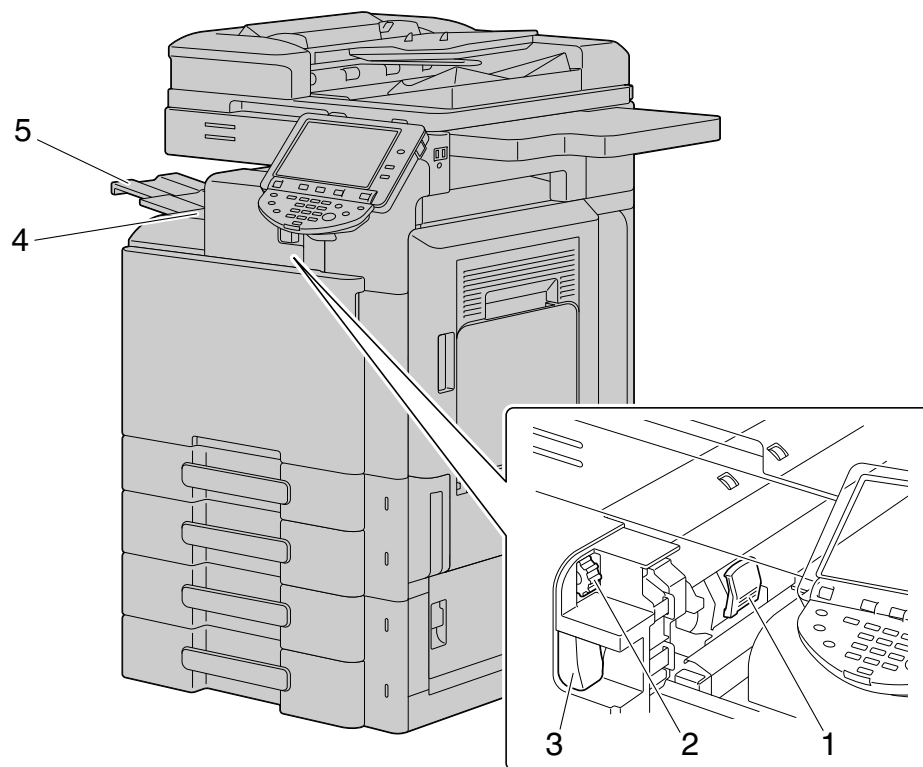

No.	Name
1	Staple Holder
2	Jam Removal Dial
3	Lock Release Lever
4	Output Tray
5	Tray Extension

2.3.3 Job Separator JS-505

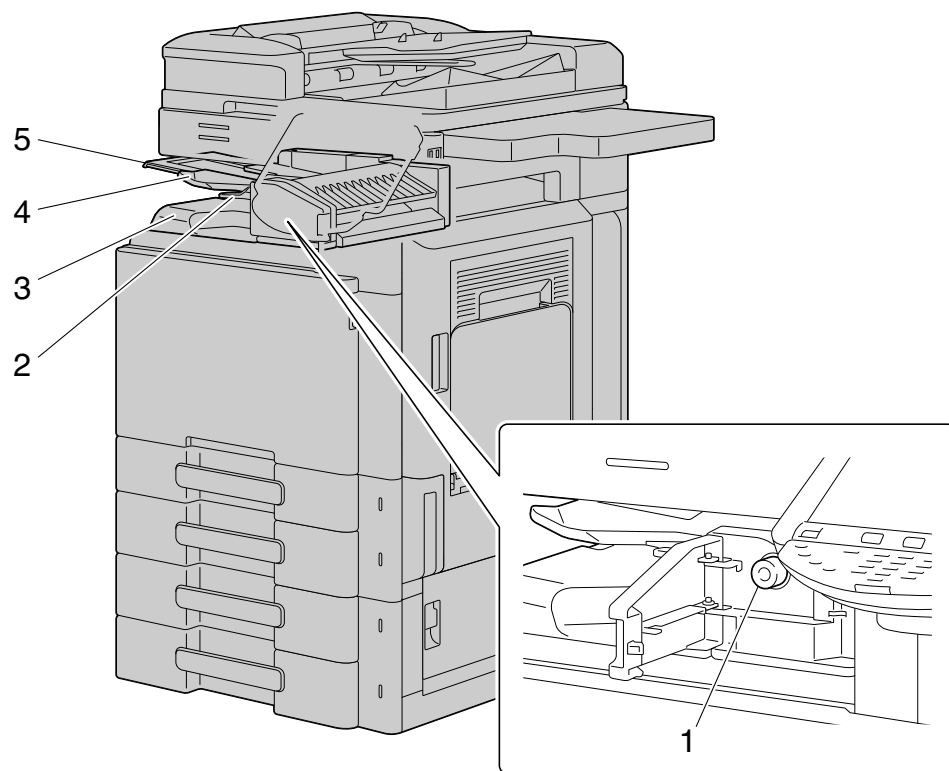

No.	Name
1	Jam Removal Dial
2	Assist Lever
3	Output Tray 2
4	Output Tray 1
5	Tray Extension

A large, bold, black number '3' is centered within a gray square. The square is positioned to the left of the text 'Using this machine'.

Using this machine

3 Using this machine

3.1 Turning on or off the machine

This machine has two power controls: the **Main Power Switch** and **Sub Power Switch**.

The **Main Power Switch** turns on or off all functions of the machine. Normally, keep the **Main Power Switch** on.

The **Sub Power Switch** turns on and off machine operations, for example, for copying, printing or scanning. Turning **Sub Power Switch** off causes the machine to enter power-saving mode.

- ✓ When the **Sub Power Switch** is turned on, the indicator on the **Start** key lights up in orange, and a screen appears to indicate that the machine is starting up. After a few seconds, the message [Warming up. Ready to scan.] appears in the touch panel, and the indicator on the **Start** key lights up in blue, indicating that a job can now be queued.
- ✓ A job can also be queued while the machine is warming up after the **Sub Power Switch** is turned on. After the machine has finished warming up, the scanned image will be printed.
- ✓ The default settings are the settings that are selected immediately after the machine is turned on and before any settings are configured from the **Control Panel** or **Touch Panel**, and those that are selected when the **Reset** key is pressed to cancel all settings configured from the **Control Panel** or **Touch Panel**. The default settings can be changed.
- ✓ Do not turn off the **Main Power Switch** while a queued job or stored data is waiting to be printed. The jobs yet to be printed will be deleted.
- ✓ Settings that have not been registered and jobs in the printing queue are cleared when the **Main Power Switch** and **Sub Power Switch** are turned off.
- ✓ To turn the **Main Power Switch** on immediately after turning it off, wait for 10 or more seconds before turning it on again. Not doing so may result in an operation failure.
- ✓ Do not turn off the **Main Power Switch** or **Sub Power Switch** while images are being scanned, transmitted, or received. Data being scanned or communicated will be deleted.
- ✓ Do not turn off the **Main Power Switch** or **Sub Power Switch** during the copying or printing process. If you turn it off, a paper jam may occur.
- ✓ Do not connect or disconnect the USB cable of the compact keyboard while this machine is turned on. Do not also connect another medium to the USB port for the compact keyboard.

- 1 To turn the power on, open the **Front Door**, and press | on the **Main Power Switch**.

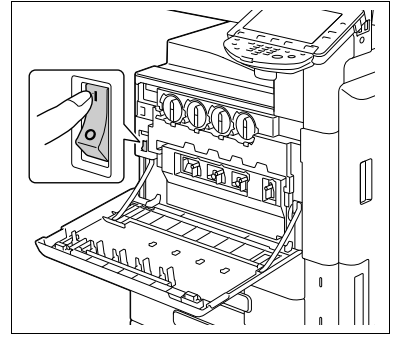

- 2 Close the **Front Door**.
- 3 Press the **Sub Power Switch**.
Check that the **Touch Panel** is turned on.

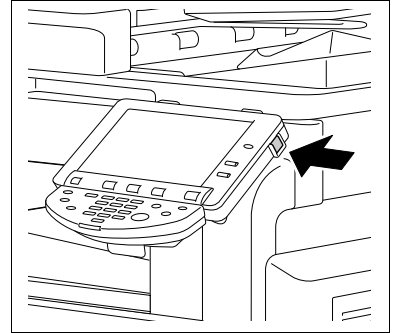

- 4 To turn the power off, press the **Sub Power Switch**, then the **Main Power Switch**.



Reference

To change the default settings for Copy:

Press the **Utility/Counter** key ►► [User Settings] ►► [Copier Settings] ►► [Default Copy Settings].

3.2 Basic copy operations

The following procedures describe how to set the original and the basic copy operations.

3.2.1 Placing originals

Place the original in the **ADF** or on the **Original Glass**. Select the optimal position for setting the original according to the type of the original to be copied.

- Using the **ADF**, a multi-page original can be fed and scanned automatically, one page at a time from the top. The ADF can also be used to automatically scan 2-sided originals.
- When using the **Original Glass**, place the original directly on the **Original Glass** for scanning. This method is suited for originals in the form of a book and the like that cannot be fed through the **ADF**.

Load the original, and configure settings for relevant functions as needed.

Loading the original into the ADF

The following types of originals should not be loaded into the **ADF**. If loaded, paper may be jammed or the original may be damaged.

- Wrinkled, folded, curled, or torn originals
- Highly translucent or transparent originals, such as OHP transparencies or diazo photosensitive paper
- Coated originals such as carbon-backed paper
- Originals printed on paper thicker than 55-7/8 lb (210 g/m²)
- Originals printed on paper thicker than 34-1/16 lb (128 g/m²) for 2-sided copying
- Originals that are bound, for example, with staples or paper clips
- Originals that are bound in a book or booklet form
- Originals with pages bound together with glue
- Originals with pages that have had cutouts removed or are cutouts
- Label sheets
- Offset printing masters
- Originals with binder holes
- Originals that have just been printed with this machine

- 1 Slide the **Lateral Guide** to fit the size of the original.

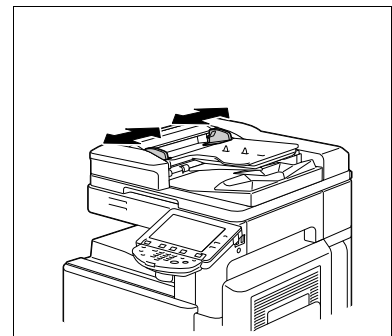

- 2 Load the original face up in the **Original Tray** and arrange according to the scanning order. Load the original by placing it so that its top side faces the back of the machine.

- Do not load more than 100 sheets or up to the point where the top of the stack is higher than the ▼ mark. Such an action may cause an original paper jam or damage to the original. It may also invite machine failure. However, an original that exceeds 100 pages can be scanned in separate batches.
- If the original is not loaded correctly, it may not be fed in straight, causing it to jam or become damaged.
- If the original is loaded in any orientation other than with the top of the original toward the back of the machine, be sure to select the original orientation.

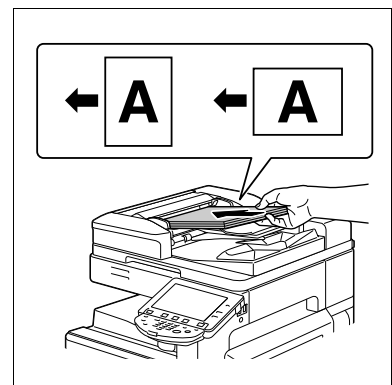

- 3 Slide the adjustable **Lateral Guide** against the edges of the original.

Placing the original on the Original Glass

- ✓ When placing an original, be sure to lift open the **ADF** or **Original Cover** at least 20 degrees. If the original is placed on the original glass without the ADF being lifted at least 20 degrees, the correct original size may not be detected.
- ✓ Do not place an original weighing more than 4-7/16 lb (2 kg) on the **Original Glass**. Furthermore, do not use a strong force to press down on a book or any other form of original that must be spread on the original glass. Otherwise, the machine may be damaged or a failure may occur.
- ✓ For thick books or large objects, perform scanning without closing the **ADF** or **Original Cover**. When a original is being scanned with the **ADF** or **Original Cover** open, do not look directly at the **Original Glass** surface where light may be emitted through. Note, however, that the light coming through the original glass is not a laser beam, and will not expose the user to the related hazards.
- ✓ When Non-Image Area Erase is selected, you do not have to close the **ADF** or **Original Cover** to copy the original. Place the original anywhere on the **Original Glass**. The area surrounding the original text will be excluded from the copy. For details, refer to page 5-45.

1 Lift open the **ADF** or **Original Cover**.

2 Place the original face down on the **Original Glass**.

→ Load the original by placing it so that its top side faces the back side of the machine.

3 Align the original with the  mark in the back-left corner of the **Original Scale**.

→ For transparent or translucent originals, place a blank sheet of paper of the same size as the original over the original.

→ For bound originals spread over two facing pages, such as a book or a magazine, position the top of the original toward the back of this machine and align the

original with the  mark in the back-left corner of the **Original Scale**.

→ When Non-Image Area Erase is selected, the original can be placed anywhere on the **Original Glass**.

4 Close the **ADF** or **Original Cover**.

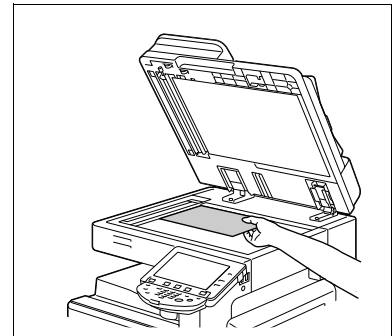

3.2.2 Basic copy operations

The following procedure describes the basic copy operations.

- 1 Arrange originals in the order you want them to be scanned and load them face up in the **ADF**.
 - The original should be placed face down on the **Original Glass**.

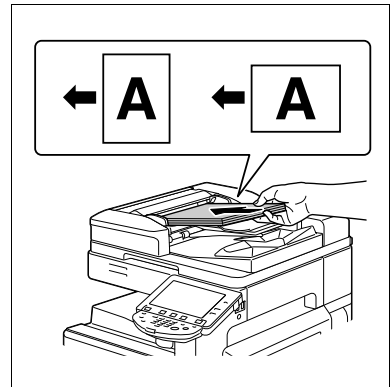

- 2 Using the **Keypad**, enter a value for the number of copies you desire.
 - If you have entered incorrect number of copies, press the **C** (clear) key on the keypad, and then re-enter the correct number.
- 3 Press the **Start** key.

The original is scanned and copied.

 - To interrupt the copy operation being performed, press the **Stop** key.
 - A [Ready to accept another job.] message that appears during the current printing job indicates that the next original can be scanned.
 - If an original with copy guard patterns embedded is scanned, the copy operation is stopped and the job is discarded.
 - If an original with a password embedded by the password copy function is scanned, the copy operation starts after you enter the password.
 - If multiple originals with different passwords are scanned at the same time, you will need to enter a password for each original.

3.2.3 Copy operations using multiple functions

This section describes copy operations using combination of functions.

- 1 Load the original.
- 2 Press [Original Setting].
 - For details on [Original Setting], refer to page 5-16.

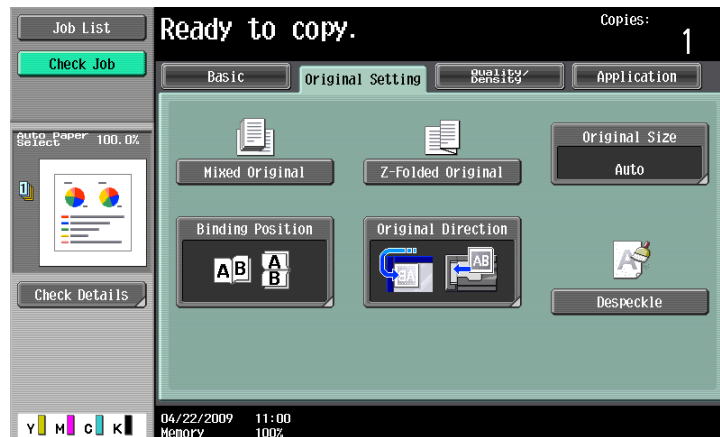

- 3 Press [Basic] ►► [Duplex/Combine].
 - For details on [Duplex/Combine], refer to page 5-9.

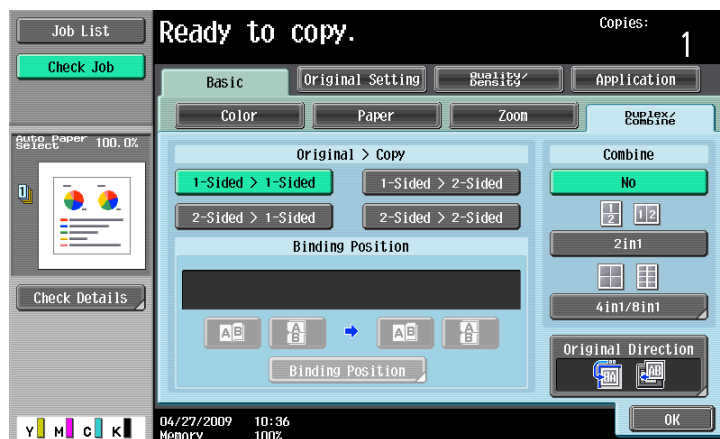

- 4 Press [Basic] and then configure settings for respective functions.
- For details on [Color], refer to page 5-5.
 - For details on [Paper], refer to page 5-6.
 - For details on [Zoom], refer to page 5-8.
 - For details on [Quality/Density], refer to page 5-19.
 - For details on [Auto Rotate OFF], refer to page 5-15.

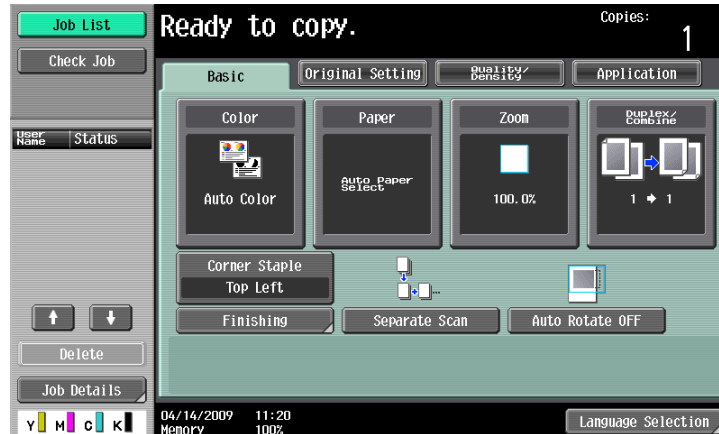

- 5 Press [Application] and then configure settings for respective functions.
- For details on the [Application], refer to page 5-22.

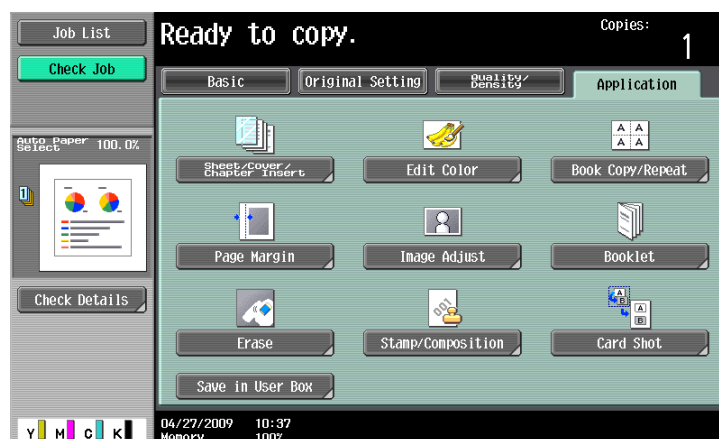

- 6 Press [Basic] ►► [Finishing].
- For details on [Finishing] or [Fold/Bind], refer to page 5-12.



- 7 Press [Check Job] ►► [Check Details].
 → For details on [Check Job], refer to page 5-65.

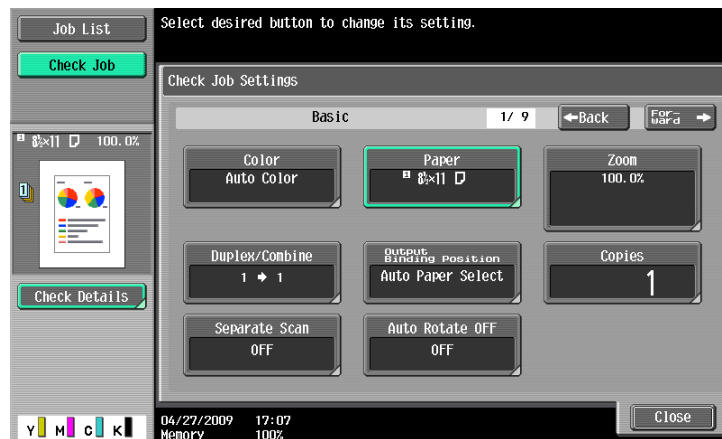

- 8 Using the **Keypad**, enter a value for the number of copies you desire.
 → If you have entered incorrect number of copies, press the **C** (clear) key on the keypad, and then re-enter the correct number.
- 9 Press the **Start** key.
 The original is scanned and copied.
 → To interrupt the copy operation being performed, press the **Stop** key.
 → A [Ready to accept another job.] message that appears during the current printing job indicates that the next original can be scanned.

Functions that cannot be combined

Some settings cannot be combined with each other. If they are combined improperly, the settings will be given priorities in either of the two ways described below.

- The setting configured last is given priority. (The setting specified first is canceled.)
- The setting configured first is given priority. (A warning message appears.)

4

Control Panel Keys

4 Control Panel Keys

This section describes the functions of the keys on the **Control Panel**.

Control Panel and functions

Press the keys on the **Control Panel** to use the Copy, Fax/Scan, User Box or other functions.

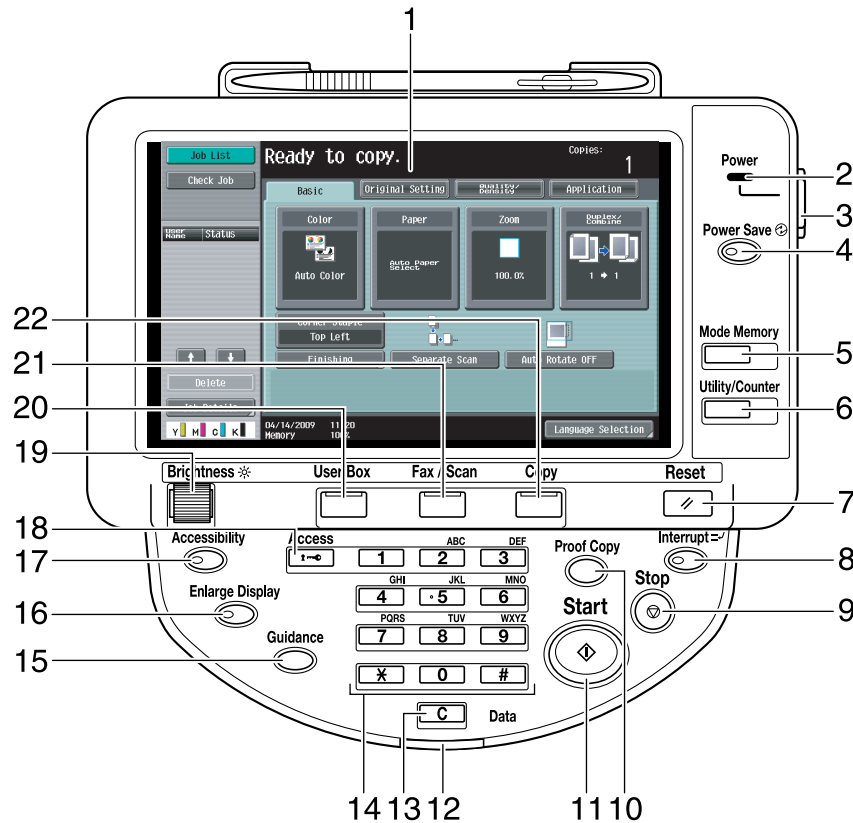

No.	Name	Description	Page
1	Touch Panel	Various screens and messages are displayed. You can configure various settings by directly pressing the Touch Panel .	—
2	Power Indicator	Lights up in blue when the machine is turned on with the Main Power Switch .	—
3	Sub Power Switch	Press this switch to turn on/off machine operations. When turned off, the machine enters an energy conservation state.	—
4	Power Save	Press this key to enter Power Save mode. While the machine is in Power Save mode, the indicator on the Power Save key lights up in green and the touch panel goes off. To exit from Power Save mode, press the Power Save key again.	p. 4-12
5	Mode Memory	Allows you to register (store) the desired copy/fax/scan settings as a program or to recall a registered program.	p. 4-8
6	Utility/Counter	Switches to the Utility screen or the Meter Count screen.	p. 4-7

No.	Name	Description	Page
7	Reset	Press this key to reset all settings (except programmed settings) entered using the Control Panel and Touch Panel .	p. 4-5
8	Interrupt	Press this key to enter Interrupt mode. While the machine is in Interrupt mode, the indicator on the Interrupt key lights up in green and the message [Now in Interrupt mode.] appears in the Touch Panel . To cancel Interrupt mode, press the Interrupt key again.	p. 4-5
9	Stop	Pressing this key while copying, scanning or printing temporarily stops the operation.	p. 4-5
10	Proof Copy	Press this key to print a single proof copy to be checked before printing a large number of copies. You can also display a finishing image using the current settings in the Touch Panel .	p. 4-19
11	Start	Press to start the copy, scan or fax operation.	p. 4-5
12	Data Indicator	Flashes in blue while a print job is being received. Lights up in blue when a print job is queued to be printed or while it is being printed. The indicator lights up in blue when there is saved fax data or unprinted fax data.	–
13	C (clear)	Clears a value (such as the number of copies, a zoom ratio and size) entered using the Keypad .	p. 4-18
14	Keypad	Allows you to specify the number of copies. Allows you to enter the magnification. Allows you to enter various settings.	–
15	Guidance	Switches to the Guidance screen. You can display descriptions of the functions and operating procedures.	p. 4-16
16	Enlarge Display	Enters Enlarge Display mode. If you are using Authentication Manager for authentication, the Enlarge Display screen will not be available.	p. 4-15
17	Accessibility	Press this key to display the screen for configuring settings for user accessibility functions.	p. 4-13
18	Access	If user authentication or account track settings have been applied, press the Access key after entering the user name and password (for user authentication) or the account name and password (for account track) in order to use this machine.	p. 4-9
19	Brightness dial	Allows you to adjust the brightness of the Touch Panel .	–
20	User Box	Press this key to enter User Box mode. While the machine is in User Box mode, the indicator on the User Box key lights up in green. For details on User Box functions, refer to the [User's Guide Box Operations].	p. 4-6
21	Fax/Scan	Enters Fax/Scan mode. While the machine is in Fax/Scan mode, the indicator on the Fax/Scan key lights up in green. For details on the fax/scan function, refer to the [User's Guide Network Scan/Fax/Network Fax Operations].	p. 4-6
22	Copy	Press this key to enter Copy mode. (The machine is in Copy mode in default.) While the machine is in Copy mode, the indicator on the Copy key lights up in green.	p. 4-6

4.1 About Start, Stop, and Interrupt

Start

- Start the copy, scan or fax operation.

Press this key again to restart a suspended job.

- When this machine is ready to begin the operation, the indicator on the **Start** key lights up in blue. If the indicator on the **Start** key lights up in orange, the copy operation cannot begin. (Check that no warning or message is displayed in the **Touch Panel**.)

Stop

- Press the **Stop** key while copying to temporarily stop the scanning or printing operation.
 - To resume a temporarily stopped job, press the **Start** key.
 - To delete a temporarily stopped job, select a job in the suspended job list in the screen, and press the [Delete] key.

Interrupt

Press this key to start a new copy job with different copy settings by suspending the current job in process. This is convenient when you need to make copies urgently.

- ✓ The **Interrupt** key cannot be operated while an original is being scanned.
- ✓ Pressing the **Interrupt** key restores the default settings.

1 Load the original.

2 Press the **Interrupt** key.

The indicator on the **Interrupt** key lights up in green and printing of the current job is suspended.

3 Configure the copy settings.

4 Press the **Start** key.

5 After the interrupting job has finished printing, press the **Interrupt** key.

The **Interrupt** indicator goes off and the interrupting copy settings are canceled.

The copy settings return to those specified before the interrupting copying job.

Reset

Press this key to reset all settings (except programmed settings) entered using the **Control Panel** and **Touch Panel**.

- Press the **Reset** key.
 - The basic settings screen appears.

4.2 About Copy, Fax/Scan, and User Box

This machine operates in Copy, Fax/Scan and User Box modes, from which the user can select a desired function. The indicator on the selected key lights up in green.

Copy

→ Press this key to enter Copy mode.

The basic settings screen appears.

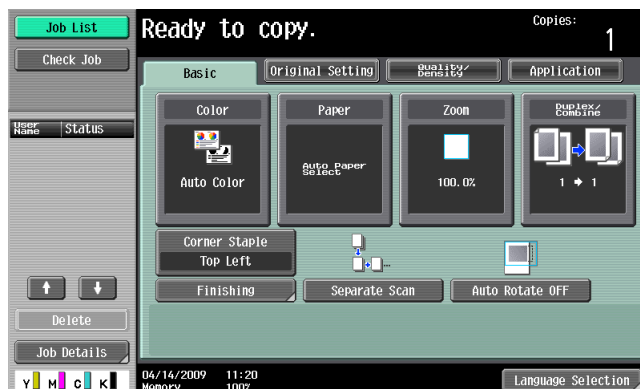

Fax/Scan

→ Press this key to enter Fax/Scan mode.

For details on the fax/scan function, refer to the [User's Guide Network Scan/Fax/Network Fax Operations].



User Box

→ Press this key to enter User Box mode.

For details on User Box functions, refer to the [User's Guide Box Operations].



4.3 Utility/Counter

Press the **Utility/Counter** key to display the Utility screen. You can configure the machine settings and check its use status in the Utility menu screen.

→ Press the **Utility/Counter** key.



Settings

[One-Touch/User Box Registration]	Allows you to register items related to the fax/scanner and User Boxes operations. For details, refer to the [User's Guide Network Scan/Fax/Network Fax Operations] and [User's Guide Box Operations].
[User Settings]	Provides setting items that can be operated by the user.
[Administrator Settings]	Provides setting items that can only be operated by the administrator of the machine.
[Check Consumable Life]	Allows you to check the status (usage level) of consumables.
[Banner Printing]	Specify whether to allow banner printing. For details on long paper print, refer to the [User's Guide Print Operations].
[Device Information]	Displays information about this machine. [Function Version]: Allows you to check the function version of the currently installed firmware. [IPv4 Address]: Allows you to check the currently specified IPv4 address. [IPv6 Address]: Allows you to check the currently specified IPv6 address.

4.4 Mode Memory

Combine frequently used copy settings into programs and register them with this machine. These programs can easily be recalled as programs.

- ✓ Up to 30 programs can be registered.
 - ✓ To register a program, configure the copy settings to be registered before pressing the **Mode Memory** key.
- Press the **Mode Memory** key.



Settings

[Recall Copy Program]	Select the key registered with the copy settings to be recalled.
[Register Program]	<ul style="list-style-type: none"> • From the keys displayed in the screen, press the key you want to register copy settings with, and then press the [Register Program]. • Enter the registration name, and then press [OK].
[Check Program Settings]	Press this button to check the copy settings registered with the selected key.
[Edit Name]	Press this button to rename the registered name of the selected key. After enabling Copy Program Lock, [Edit Name] will not be displayed.
[Delete]	Press this button to delete the selected key. After enabling Copy Program Lock, [Delete] will not be displayed.



Reference

To prohibit modification and deletion of programs:

Press the **Utility/Counter** key ▶▶ [Administrator Settings] ▶▶ [System Settings] ▶▶ [Restrict User Access] ▶▶ [Copy Program Lock Settings].

To delete a program:

Press the **Utility/Counter** key ▶▶ [Administrator Settings] ▶▶ [System Settings] ▶▶ [Restrict User Access] ▶▶ [Delete Saved Copy Program].

4.5 Access

If the administrator has configured user authentication settings/account track settings, only the users who have been registered or the users whose accounts have been registered can use this machine.

If the administrator has configured a usage schedule, a user can use the machine by entering a password for non-business hours.

Controlling access to the machine by user/account (user authentication/account track)

- ✓ With the user authentication/account track functions enabled, only the users who enter passwords for users or for accounts can use this machine.
- ✓ Thus, the number of copies among others can be managed by user/account.
- ✓ Contact the administrator for information on the user name, account name, password and server name.
- ✓ The login page that appears may vary depending on the user authentication/account track settings.
- ✓ User Authentication can be used together with Account Track. If the User Authentication/Account Track is set to [Do Not Synchronize], complete user authentication, and then log in by using the Account Track screen.
- ✓ If MFP authentication or external server authentication has been set, a total of 1000 users and accounts can be registered.
- ✓ After copying is completed, press the **Access** key to log out from the machine.
- ✓ You can use the authentication unit for authentication to handle this machine.
- ✓ The user, who sets the use of this machine to suspend in User Authentication Settings, cannot log in to this machine.
- ✓ The account, which sets the use of this machine to suspend in Account Track Settings, cannot log in to this machine. The users, who belong to the suspended account, cannot also log in to this machine.
- ✓ If authentication is performed with **Authentication Manager**, check with your server administrator for information on the login procedure.

→ Press the **Access** key.

Screen for user authentication

The screenshot shows a user authentication interface. On the left side, there is a 'Job List' section with a table header 'User Name' and 'Status'. Below it are navigation buttons: 'Delete', 'Job Details', and a set of four colored buttons (Y, M, C, K). On the right side, there is a login form with the following elements:

- A header instruction: "Enter a login user name and password, and then touch [Login] or press [Access]."
- A 'Public User Access' button at the top right.
- A 'User Name' input field with a 'User Name List' button to its right.
- A 'Password' input field.
- A 'Server Name' input field with 'Server1' pre-filled.
- A green 'Login' button at the bottom right.

The bottom status bar displays: '04/27/2009 09:34' and 'Memory 100%'.

Screen for account track



Settings

User Authentication	Performs the user authentication procedure to use this machine.	
	[Public User Access]	Allows users who have no access to the [User Name] or [Password] to use this machine. This item is not displayed when [Public User Access] is set to [Restrict] in [General Settings] of [Administrator Settings]. If [Enhanced Security Mode] has been enabled, [Public User Access] is not displayed.
	[User Name]	Enter the user name.
	[User Name List]	Select a user name from a displayed list. <ul style="list-style-type: none"> If [Enhanced Security Mode] has been enabled, [User Name List] is not displayed. The user, who has set the use of this machine to suspend in User Authentication Settings, is not displayed in the [User Name List].
	[Password]	Enter the password.
	[Server Name]	Indicates the name of the default server. Press [Server Name] to display the names of the registered servers. Select the desired server.
	[Login]	Displays the basic settings screen, enabling you to use this machine.
Account Track	Performs the account track procedure to use this machine.	
	[Account Name]	Enter the account name.
	[Password]	Enter the password. When the [Account Track Input Method] is set to [Password Only] in [Administrator Settings], the login screen displays only [Password]. The user can directly enter the password in the login screen from the keypad. For an all-number password, the user can log in without displaying the keyboard screen, simply by pressing [Login], or the Access key. <ul style="list-style-type: none"> For a password containing alphabets, numbers and/or symbol characters, press [Password] and then enter the password. After entering numbers from the keypad, press [Password] to enter alphabets and symbols in succession.
[Login]	Displays the basic settings screen, enabling you to use this machine.	



Reference

To configure user authentication/account track:

Press the **Utility/Counter** key ►► [Administrator Settings] ►► [User Authentication/ Account Track].

Using the machine during non-scheduled hours

The machine can be set to automatically enter Sleep mode according to a usage schedule determined by the administrator so the use of the machine can be limited. This is referred to as Weekly Timer. Follow the procedure described below to use the machine while the Weekly Timer is being used.

- ✓ From the [Password for Non-Business Hours] screen (displayed from Administrator Settings mode), the machine can be set so that the screen for entering the password for non-business hours is not displayed.

- 1 Press the **Power Save** key.
- 2 Enter the password for non-business hours.
- 3 Press [OK].
- 4 Using the keypad, enter the length of time to elapse before the machine enters Sleep mode again.

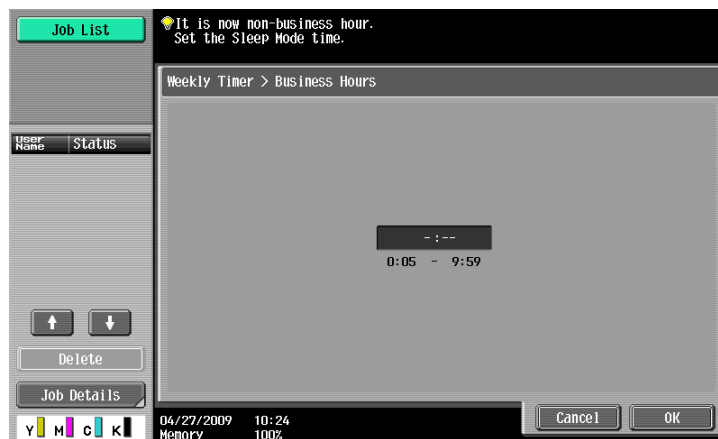

- 5 Press [OK].
The basic settings screen appears.



Reference

To configure Weekly Timer:

Press the **Utility/Counter** key ►► [Administrator Settings] ►► [System Settings] ►► [Weekly Timer Settings].

4.6 Power Save

If no operation is performed for a specified length of time, the touch panel goes off and the machine automatically enters a mode where it conserves energy. This is referred to as Low Power or Sleep mode.

The following describes the procedure for returning from Low Power or Sleep mode.

- ✓ Although the machine conserves more energy in Sleep mode than in Low Power mode, the warm-up process for returning to ready-for-copy state from Sleep mode is more time-consuming.
- ✓ As the factory default, Low Power mode is set to restart after 15 minutes and Sleep mode after 20 minutes. In other words, the machine enters Low Power mode if no operation is performed for 15 minutes. Likewise, it enters Sleep mode after 20 minutes has elapsed.
- ✓ The machine can receive jobs even while it is in Low Power mode.

→ Press the **Power Save** key.

The machine returns from Low Power mode when any other key on the **Control Panel** or the **Touch Panel** surface is pressed.



Reference

To enable Low Power mode:

Press the **Utility/Counter** key ►► [Administrator Settings] ►► [System Settings] ►► [Power Save Settings].

4.7 Accessibility

This section describes the procedures for configuring settings for the **Control Panel** and adjusting the **Touch Panel**.

- ✓ To return to the basic settings screen from the Accessibility Setting screen, press the **Accessibility** key, the **Reset** key or [Close].
- ✓ In the Enlarge Display screen, [Default Enlarge Display Settings] appears, enabling you to configure default settings for use in the Enlarge Display mode using the copy or fax/scan functions.

→ Press the **Accessibility** key.

Page 1/2

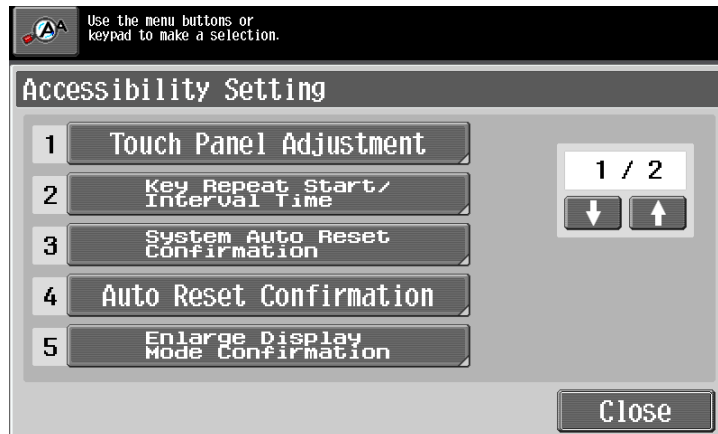

Page 2/2

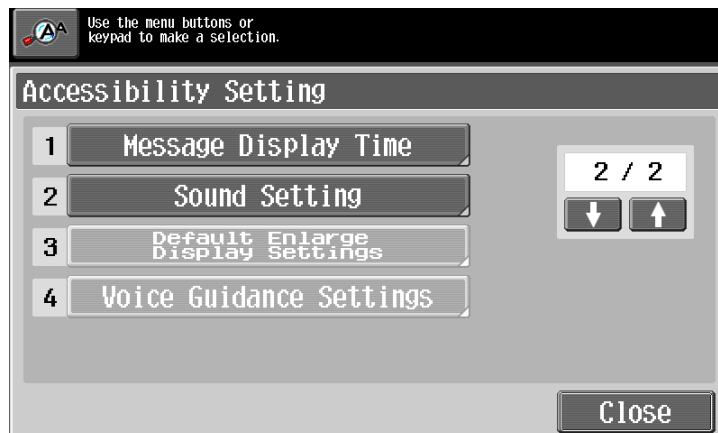

Settings

[Touch Panel Adjustment]

If no normal reaction is returned after pressing a key on the **Touch Panel**, the key display position on the **Touch Panel** may not be correctly aligned with the actual position of the touch sensor.

Adjust the display position of the **Touch Panel**.

- The touch sensors are not aligned in the touch panel if pressing [Touch Panel Adjustment] does not activate any action. Press the **1** key on the **Keypad**.
- Press the four check point buttons ([+]) on the touch panel adjustment screen while listening on a buzzer sound each time. When the checking by pressing the check point buttons is completed successfully, the indicator on the **Start** key lights up in blue. Press the **Start** key.
- The check point buttons ([+]) can be pressed in any order.
- To perform adjustment again, press the **C** (Clear) key, and then press the four check point buttons ([+]) again.
- To cancel the **Touch Panel** adjustment process, press the **Stop** or **Reset** key.
- If the touch panel cannot be adjusted, contact your service representative.

Settings	
[Key Repeat Start/Interval Time]	Specify the length of time until the value begins to change after a Touch Panel button is held down, and also specify the length of time for the value to change to the next number. The settings specified for Key Repeat Start/Interval Time are only applied in Enlarge Display mode.
[System Auto Reset Confirmation]	Specify whether to display a message when the system auto reset operation is performed in Enlarge Display mode, allowing the user to choose either to continue operating without exiting Enlarge Display mode or to exit Enlarge Display mode and return to the basic settings screen. Also specify the duration of time for displaying the confirmation screen.
[Auto Reset Confirmation]	Specify whether to display a message when the automatic panel reset operation is performed in Enlarge Display mode, allowing the user to choose either to continue operating without resetting the current settings or to reset the settings. Also specify the duration of time for displaying the confirmation screen.
[Enlarge Display Mode Confirmation]	Specify whether to display a message when the Enlarge Display key is pressed to change the display of the screen, requesting confirmation to cancel the settings that cannot be specified in Enlarge Display mode.
[Message Display Time]	Specify the duration of time for displaying warning messages, which appear, for example, when an incorrect operation is performed.
[Sound Setting]	Configure the settings for sounding associated with key operations. The following sound setting functions are available. To produce a sound, press [Yes], and then select the volume from [Low], [Medium] and [High]. To not produce a sound, press [No]. [Operation Confirmation Sound] <ul style="list-style-type: none"> [Input Confirmation Sound]: A sound produced when a key in the Control Panel or a button in the Touch Panel is pressed for an entry [Invalid Input Sound]: A sound produced for invalid button operation in the Control Panel or the Touch Panel [Basic Sound]: A sound produced when the default value item is selected for an option subject to rotational switching [Successful Completion Sound] <ul style="list-style-type: none"> [Completed Operation Sound]: A sound produced when the operation has completed normally [Completed Transmission Sound]: A sound produced when a communications-related operation is completed normally [Completed Preparation Sound]: A sound produced when a device is ready [Caution Sound] <ul style="list-style-type: none"> [Simple Caution Sound (Level 1)]: A sound produced when the replacement time is nearing for supplies or a replaceable part and a message appears in the Touch Panel [Simple Caution Sound (Level 2)]: A sound produced for a user error [Simple Caution Sound (Level 3)]: A sound produced when an error occurs that can be corrected by the user by referring to the message that appears or the User's Guide [Severe Caution Sound]: A sound produced when the door or cover is opened or when an error occurs that requires action by a service representative
[Default Enlarge Display Settings]	For details, refer to the [User's Guide Enlarge Display Operations].

4.8 Enlarge Display

Press this key to enter Enlarge Display mode and enable machine operation using a screen with a layout with larger-size characters.

For details on the Enlarge Display screen, refer to the [User's Guide Enlarge Display Operations].

- ✓ Press the **Enlarge Display** key to return to normal display.
 - ✓ If **Authentication Manager** is used for authentication, the login screen cannot be switched to the enlarged display mode.
- ➔ Press the **Enlarge Display** key.

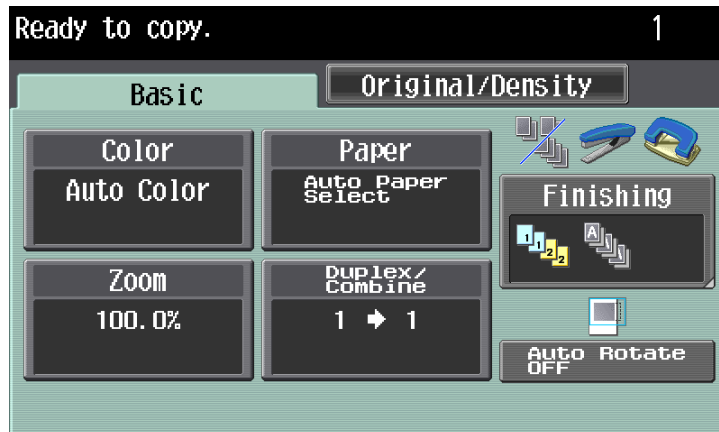

4.9 Guidance

Press this key to view and check descriptions of various functions and operating procedures. When the **Guidance** key is pressed, the Guidance screen for the displayed screen appears.

- ✓ From the Help main menu screen, you can find the target Guidance screen based on the function or purpose.
 - ✓ Refer to the left panel of the Guidance screen to check the position of the displayed Guidance screen in the menu structure.
 - ✓ Press [Close] in the Guidance screen to move up one level in the menu structure. Press [Exit] to exit Guidance mode and return to the screen that was displayed before the **Guidance** key was pressed. Press [To Menu] to display the Help main menu.
 - ✓ In the Main Menu and Guidance Menu screens, select items by pressing the button or by pressing the key in the keypad.
 - ✓ The Guidance screens cannot be displayed when the following operations are being performed: Scanning, printing a proof copy, preview of a finished copy, operating in Enlarge Display mode, or operating in Accessibility mode.
 - ✓ While the Guidance screen is displayed, the following keys on the operation panel are disabled: **Start, C(Clear), Interrupt, Proof Copy, Access, Mode Memory, and Enlarge Display**
- ➔ Press the **Guidance** key.

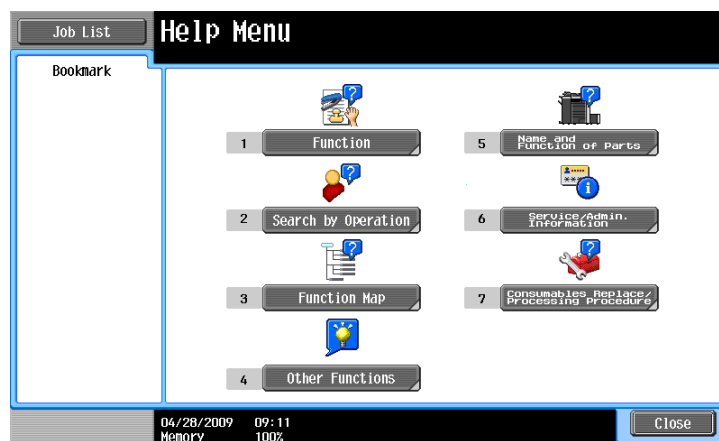

Settings

[Function]	Check descriptions by selecting a Guidance menu grouped by function type and name.
[Search by Operation]	Check descriptions by selecting a Guidance menu grouped by operation type. <ul style="list-style-type: none"> • With [Go to function] displayed, the function for the selected operation can be set. However, when the fax/scan function is used, for example, [Go to function] displayed on a Guidance screen for the copy function, for example, cannot be selected as it is a different function from the one in use. • Select [Copying] and press [Copying Special Documents]; instructions and animation guidance are displayed to enable the user to view the procedure for placing an original. However, Start Guidance is not displayed in the animation guidance for placing an original.
[Function Map]	Check descriptions from a navigation destination of the current screen or the menu structure it belongs to.
[Other Functions]	Check descriptions by selecting a Guidance menu grouped by useful function.
[Name and Function of Parts]	Check the description of the main unit and its options.
[Service/Admin. Information]	Check the [Admin. Name], [Extension No.], and [E-Mail].

Settings

[Consumables Re-
place/Processing Proce-
dure]

Check procedures for replacing the **Toner Cartridge**, **Drum Unit**, or **Waste Toner Box**, adding staples, or disposing punch-hole scraps by viewing animations. Press the target button, and then press [Start Guidance].

4.10 C (Clear)

Clears a value (such as the number of copies, a zoom ratio and size) entered using the keypad.

→ Press **C** (Clear).

The value is deleted. Enter the correct value.

4.11 Proof Copy

Printing one set to check the copy result (Proof Copy)

Print a single proof copy for checking before printing a large number of copies. This prevents copy errors from occurring.

- ✓ To perform Proof Copy, specify multiple copies.

- 1 Load the original.
- 2 Select the desired copy settings.
- 3 Press the **Proof Copy** key.
- 4 Press [Print] and then select the original direction.

- 5 Press the **Start** key.

This prints one copy when the original has been loaded in the **ADF**.

- 6 When it has been loaded on the **Original Glass**, press the [Finish], then the **Start** key.
A single proof copy is printed.

- 7 Check the proof copy.

- If the proof copy is found all right, go to Step 10.
To change the copy settings, go to Step 8.

- 8 Press [Change Setting] in the proof copy screen.

After changing the copy settings in the Change Settings screen, press [OK].

- [Number of Sets] in the proof copy screen indicates the number of sets printed in the proof copy mode/the number of sets specified to be printed, and [Total # of Pages Printed] indicates the number of sheets printed in the proof copy mode/the total number of sheets to be printed.

- To stop copying while the screen for changing the settings is displayed, select the proof copy job to be stopped from the list of jobs in the left panel, and then press [Delete].

- If no operation is performed for the specified length of time while this screen is displayed, the copy job for which proof copy has been completed is registered as a stored job and the basic settings screen appears again.

Stored job registration is performed when the System Auto Reset function is activated or one minute after (if System Auto Reset is set to [OFF]).

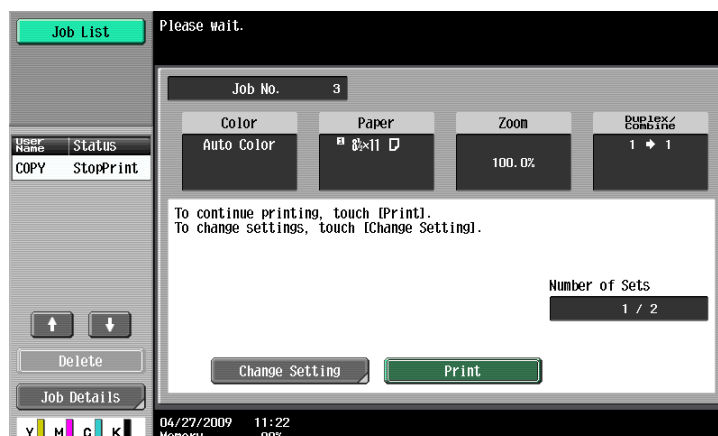

- 9 Press the **Proof Copy** key to repeat proof copy.

- 10 Press [Print].

The number of copies yet to be printed is registered as a copy job.

Using a preview image to check the copy result (Advanced Preview)

Check the finishing image of a copy in the **Touch Panel** before printing. This prevents copy errors from occurring.

- ✓ When you scan the original using the [Program Jobs] function, scan all originals, press [Finish], and then check the [Advanced Preview].
- ✓ When you attempt to scan the original with an [Insert Image] specified, the machine scans the original first, and then the insert original. When this process is complete, you can check the [Advanced Preview].
- ✓ To use the [Book Copy] or [Booklet] function, no preview is available. Check the finishing state after printing.
- ✓ If [Copy Guard] is detected, you cannot check finishing.

- 1 Load the original.
- 2 Select the desired copy settings.
- 3 Press the **Proof Copy** key.
- 4 Press [Preview on Screen] for the proof copy method and then select the original direction.
- 5 Press the **Start** key.
The Preview (View Status) screen appears.
- 6 Check the preview image.
 - To change the settings, press [View Pages]. Go to Step 7.
 - To start printing, press the **Start** key.
 - To scan another original, press [Finish], load the original, and then press the **Start** key.
- 7 Change the settings, and then press [View Status].

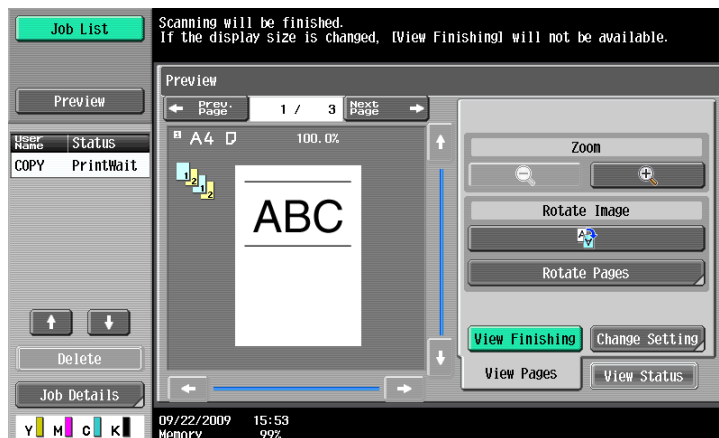

Settings

[← Prev. Page]/ [Next Page →]	Switch from the current screen to either the previous or the next screen.
[Zoom]	Enlarge the preview image and check the details. Press [+] and [-] to change the zoom ratio from full size to 2, 4 or 8 times the normal size. To select a different area to be enlarged, touch the scroll bar arrows on the right and at the bottom side of the image. The finishing state cannot be displayed if you change the display size.
[Rotate Image]	Rotate the preview image 180 degrees in order to correct the orientation of the original if necessary. Pressing [Rotate Image] rotates the currently displayed page. Pressing [Rotate Pages] displays the Scanned Page List. Select the page to be rotated. Up to six scanned pages can be displayed. Press [↑] or [↓] to change the selection.

Settings

[View Finishing]	View the finishing settings using icons or in text on the preview screen, and check the finishing state.
[Change Setting]	Change the settings for the next original to be scanned.
[View Pages]/[View Status]	Switch between the [View Status] and [View Pages] tab in the Preview screen. Use [View Pages] to enable [Page Rotation] or [Change Setting], and stop scanning on [View Status].

- 8 Press the **Start** key.
Select this menu to start printing.

5

Copy Function

5 Copy Function

You can configure the settings for multiple copy features by pressing buttons on the **Control Panel** or **Touch Panel**.

This chapter describes the functions that can be configured by pressing the buttons in the **Touch Panel**.

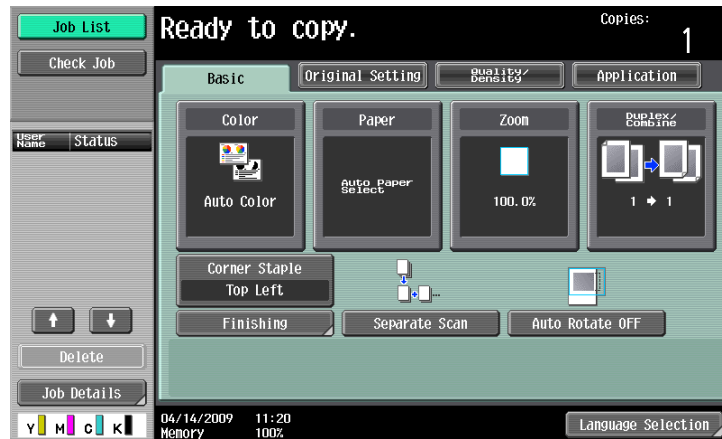

Item

[Basic]	Configure the basic settings for making copies.	p. 5-4
[Original Setting]	Configure the type and size of the original.	p. 5-16
[Quality/Density]	Configure the quality or density for the original to optimize copy quality.	p. 5-19
[Application]	Configure the application settings for making copies.	p. 5-22
Left panel	[Job List]	Check jobs currently being performed and jobs waiting to be performed.
	[Check Job]	Check the current settings and the result of the settings.

5.1 [Basic]

Configure the basic settings for making copies.

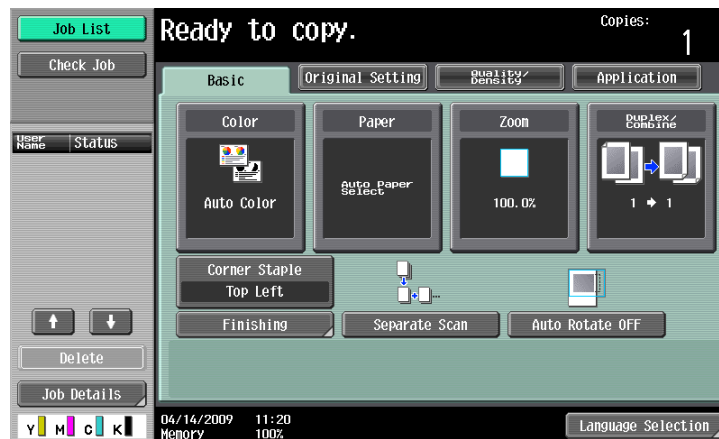

Item		
[Color]	Press this button to specify the print color for making copies.	p. 5-5
[Paper]	Press this button to configure the paper type and paper tray for making copies.	p. 5-6
[Zoom]	Press this button to select the zoom ratio of the image to be copied.	p. 5-8
[Duplex/Combine]	Configure the 2-sided copy and combined copy settings.	p. 5-9
[Finishing Program]	Configure frequently used offset and finishing settings in advance. You can activate preferred finishing functions by simply pressing this button.	p. 6-9
[Finishing]	Press this button to select the settings for sorting and the finishing state of copies.	p. 5-12
[Separate Scan]	Select this item to divide a large number of original and scan it in a number of batches.	p. 5-14
[Auto Rotate OFF]	Select this item to copy the original according to the paper orientation without rotating the image.	p. 5-15
[Language Selection]	Display the Language Selection screen to specify the language to be displayed on the Touch Panel . This item is not displayed when two shortcut keys are configured.	–
[Shortcut Key]	Allows you to arrange shortcut keys for the frequently used Application functions on the Basic screen.	–

5.1.1 [Color]

Press this button to select the print color for making copies.

For the print color, you can select one from [Auto Color], [Full Color], [2 Color], [Black] and [Single Color].

→ Press [Basic] ►► [Color].



Settings

[Auto Color]	Select this setting to automatically detect whether the scanned original is in color or in black and white, and then select the appropriate color setting (full color or black).
[Full Color]	Select this setting to print the copy in full color, regardless of whether the scanned original is in color or in black and white.
[2 Color]	Prints all areas of the scanned original determined to be in color with the specified color, and prints all areas determined to be black in black.
[Black]	Select this setting to print the copy in black and white, regardless of whether the scanned original is in color or in black and white.
[Single Color]	Prints the copy in the specified single color, regardless of the color of the scanned original. When you specify a single color, the original is copied by converting the color differences (apparent color densities) and the gradation levels into density differences of the single color.
[Average Density]	Copies the original by only converting the gradation levels into density differences of the single color, regardless of the color differences in the original.

5.1.2 [Paper]

Select the paper type and size to be printed or change the paper size and paper type settings configured for each paper tray.

The paper size can be selected automatically according to the original size or it can be specified manually.

- ✓ When you select [Transparency], specify [Black] for [Color] in advance.
- ✓ The auto zoom setting and the auto paper setting cannot both be selected at the same time.
- ✓ If a setting for special paper is selected for a paper tray, that tray is not selected automatically with the Auto Paper setting. (However, a paper tray set to Single Side Only is given priority to be selected with 1-sided printing.) When setting special paper in the paper tray, be sure to set the paper type. For details on special paper, refer to page 12-3.

→ Press [Basic] ►► [Paper].



Settings

[Auto]	Automatically selects the paper size according to the original size.
1 to 4 Trays	Allows you to specify the paper manually.
[Bypass Tray]	
[Change Tray Settings]	Specify the paper type and paper size for the selected paper tray.
[Paper Type]	Specify the paper type for the selected paper tray.
[Paper Size]	Specify the paper size for the selected paper tray. [Auto Detect]: Automatically detects the paper size. [12-1/4x18] (Only for [Tray 2]): Enables 12-1/4x18 to be selected. [Standard Size] (only for [Bypass Tray]): Specify a paper size to use the bypass tray as a paper tray dedicated to the paper size. [Custom Size] (only for [Bypass Tray]): Enter the paper size. [Wide Paper]: Select a paper size larger than the original.

Configuring a custom size

→ [Basic] ▶▶ [Paper] ▶▶ [Bypass Tray] ▶▶ [Change Tray Settings] ▶▶ [Custom Size].

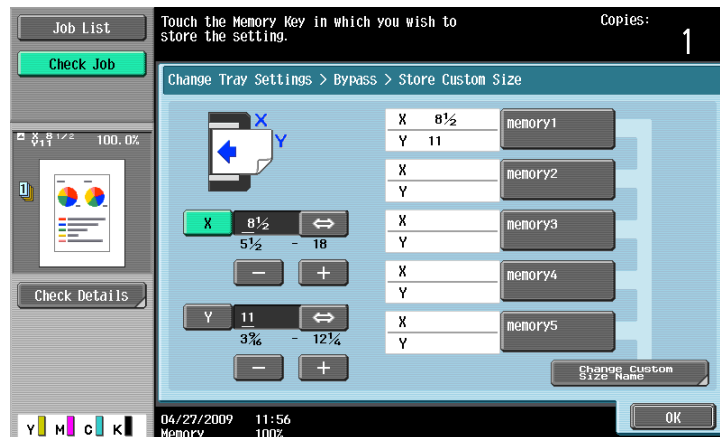

Settings

[X]/[Y]	<ul style="list-style-type: none"> Inch area: Press [+] or [-] to specify the length [X] and width [Y] of the paper. Metric area: Enter the length [X] and width [Y] of the paper.
[Store]	Register custom paper sizes.
[memory1] to [memory5]	Select the memory button where the paper size is to be stored.
[Change Custom Size Name]	Rename memory button names.

Configuring wide paper

→ [Basic] ▶▶ [Paper] ▶▶ [Bypass Tray] ▶▶ [Change Tray Settings] ▶▶ [Wide Paper].

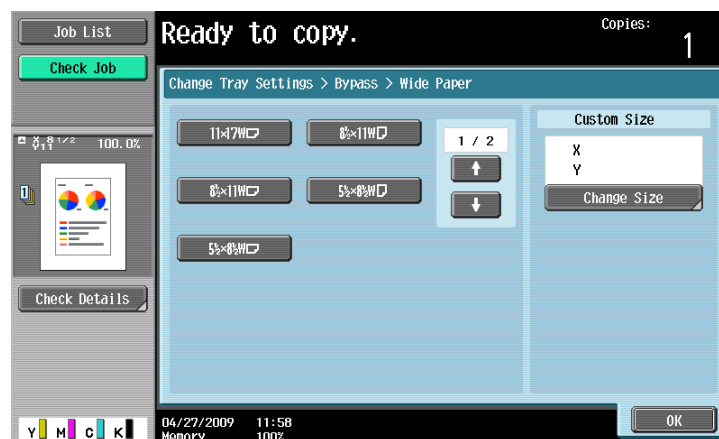

Settings

[Wide Paper]	Select the size of the paper to be loaded.	
[Change Size]	[X]/[Y]	Enter the length [X] and width [Y] of the paper.
	[Preset Paper Sizes]	Enables [12x18 

5.1.3 [Zoom]

Image size in the original can be enlarged or reduced.

- ✓ The auto zoom setting and the auto paper setting cannot both be selected at the same time.
- ✓ If the auto zoom setting is selected and an enlargement is to be copied on paper larger than the original, load the original with the same orientation as the paper.

→ Press [Basic] ►► [Zoom].

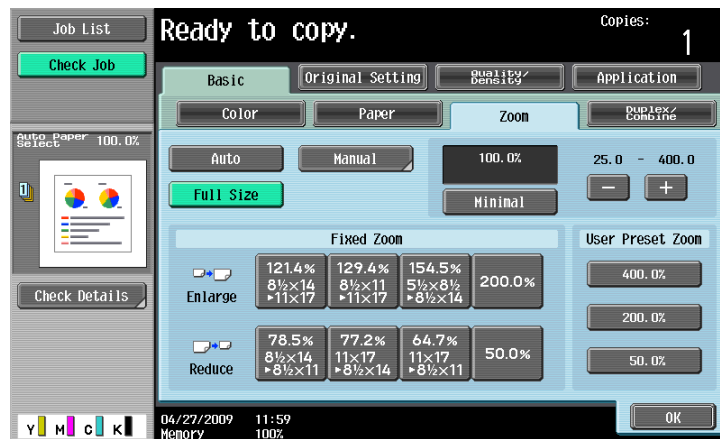

Settings

[Auto]	The most appropriate zoom ratio is automatically selected based on the size of the loaded original and the specified paper size.	
[Full Size]	A copy that is the same size as the original (100%) is produced.	
[Manual]	<ul style="list-style-type: none"> • Enter the zoom ratio (25.0% - 400.0%) of the copy. • Under [Set Individual Zoom], you can enter different zoom ratios for the X and Y directions. 	
	[Set Zoom]	Enter the desired zoom and select the button to register the value with. [User Preset Zoom] indicates the registered zoom.
[Minimal]	Copies an original image slightly smaller than the original size or the specified size. The image in the original is centered on the paper without any cutoff. Select this setting when you want to copy the entire scope of the original within the paper used.	
[-]/[+]	Configure the zoom ratio (25.0% - 400.0%) of the copy without changing the aspect ratio.	
[Fixed Zoom]	Select a preset zoom when copying from a fixed size original onto a fixed size paper.	
[User Preset Zoom]	Select a registered copy zoom value. To change the registered zoom values, use [Set Zoom].	



Reference

To set image rotation:

Press the **Utility/Counter** key ►► [User Settings] ►► [Copier Settings] ►► [Enlargement Rotation].

5.1.4 [Duplex/Combine]

Single-sided or double-sided for both the original and the copy can be specified. Multiple (2, 4 or 8) pages of original images can be reduced in size and printed on a single page.

Using the [Duplex/Combine] function, you can save paper sheets for copying.

→ Press [Basic] ►► [Duplex/Combine].



Settings

[1-Sided > 1-Sided]	
[2-Sided > 1-Sided]	
[1-Sided > 2-Sided]	
[2-Sided > 2-Sided]	

Settings

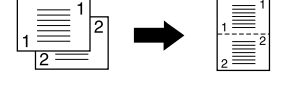
[Binding Position]	<p>Configure the binding position of the original and copies to be output. Without setting the [Binding Position], the resulting copy may not be what you intended.</p> <p>When [1-Sided > 1-Sided] is selected, the [Binding Position] cannot be set.</p>
[Original Binding Position]	<p>Select the original binding position from [Left Bind], [Right Bind], [Top] and [Auto].</p> <ul style="list-style-type: none"> • If the binding position for the original is set to [Auto], the position of the binding margin is automatically selected. A page margin position along the long side of the paper is selected if the original length is 11-11/16 inches (297 mm) or less. A page margin along the short side of the paper is selected if the original length exceeds 11-11/16 inches (297 mm). • If [Auto] is selected for the original binding position, the binding margin is set at the top or on the left.
[Output Binding Position]	<p>Select the output binding position from [Left Bind], [Right Bind], [Top] and [Auto].</p> <ul style="list-style-type: none"> • If the binding position for the copy is set to [Auto], the binding position is automatically determined according to the orientation of the loaded original. If the original length is 11-11/16 inches (297 mm) or less, a binding position along the long side of the paper is selected. If the original length is more than 11-11/16 inches (297 mm), a binding position along the short side of the paper is selected. • If Output Binding Position is set to [Auto], the binding position is set at the top or on the left.
[Original Direction]	<p>Select the orientation of the original loaded into the ADF or placed on the Original Glass.</p> <p>Without setting [Original Direction], the resulting copy may not be what you intended.</p>
[No]	<p>Disables combined copy.</p>
[2in1]	<p>Copies images on two original pages on one sheet of paper.</p> <p>Portrait original pages</p>  <p>Landscape original pages</p> 

Settings

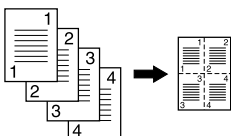
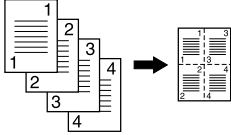
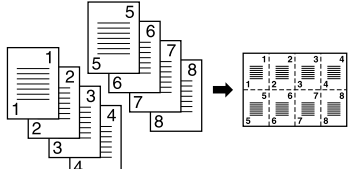
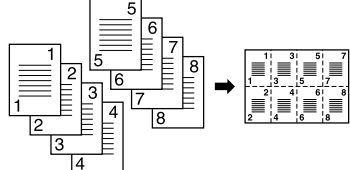
<p>[4in1/8in1]</p>	<p>[4in1]</p>	<p>Copies images of four original pages on one sheet of paper.</p> <p><Horizontal></p>  <p><Vertical></p> 
	<p>[8in1]</p>	<p>Copies images of eight original pages on one sheet of paper.</p> <p><Horizontal></p>  <p><Vertical></p> 
<p>[Horizontal]</p>	<p>[Vertical]</p>	<p>Specify the combine order of the original (Numbering Direction setting).</p>

5.1.5 [Finishing]

Various settings can be selected for sorting and finishing copies fed into the copy output tray.



- ✓ The staple function is available only if the optional **Finisher FS-527** or **Finisher FS-529** is installed.
 - ✓ The Punch settings are available only if the **Punch Kit PK-517** is installed on the optional **Finisher FS-527**.
 - ✓ [Fold/Bind] is available only if the **Saddle Stitcher SD-509** is installed on the optional **Finisher FS-527**.
 - ✓ [Staple] cannot be used together with [Offset].
 - ✓ [Half-Fold] and [Center Staple & Fold] cannot be used together with any of [Offset], [Staple], or [Punch].
- ➔ Press [Basic] ►► [Finishing].

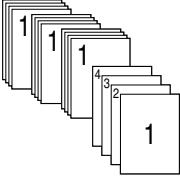
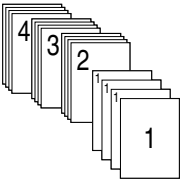

Settings

[Sort]	<p>When multi-page originals are copied for multiple sets, copies can be fed out sorted by set of copies.</p> 
[Group]	<p>When multi-page originals are copied for multiple sets, copies can be fed out sorted by pages.</p> 

Settings

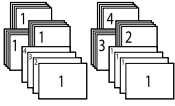
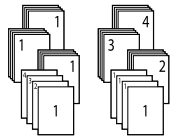
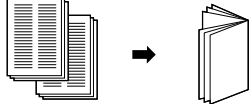
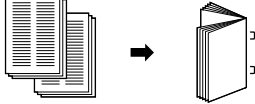
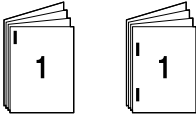
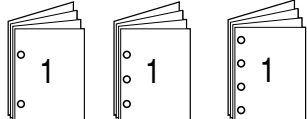
[Offset] [Yes]/[No]	<p>Specify whether to separate each set of copies from another set in the output tray when copying multiple sets of multi-page originals.</p> <p>When the Finisher FS-527, Finisher FS-529, or Job Separator JS-505 is not installed: If the following conditions are met, printed copies are fed out and sorted in an alternating crisscross pattern.</p> <ul style="list-style-type: none"> • The 8-1/2×11, A4, or B5 size paper is used • Paper of the same size and type is loaded with the  orientation in one paper tray and with the  orientation in another tray • Auto paper selection is specified for the paper size setting  <p>When the Finisher FS-527, Finisher FS-529, or Job Separator JS-505 is installed: The copies are fed out and stacked on top of each other with each set shifted to separate it.</p> 
[Fold/Bind]	<p>Staples copy outputs in the center the paper or fold them in the center before discharging.</p> <p>[Half-Fold]  [Center Staple & Fold] </p>
[Staple]	<p>Staples copies in corner or at two points before they are output.</p> 
[Punch]	<p>Punches holes in copies before they are output.</p> 
[Position Setting]	<p>Configure desired staple or hole-punch positions.</p> <p>Select Auto, and the machine automatically judges the staple or punch positions for the paper relative to the original direction loaded.</p> <ul style="list-style-type: none"> • A staple or punch position along the long side of the paper is selected if the original length is 11-11/16 inches (297 mm) or less. • A staple or punch position along the short side of the paper is selected if the original length exceeds 11-11/16 inches (297 mm). • Staple or punching positions are set on the upper or left-side end. • Be sure to load the original so that its top side is placed in the back. • If desired, press [Original Direction], and then select the original direction.

5.1.6 [Separate Scan]

When the original contains pages exceeding the capacity of the **ADF**, you can divide the original into several batches to handle each lot as a single copy job. You can also use the copy function by switching between the **ADF** and the **Original Glass** for scanning the originals.

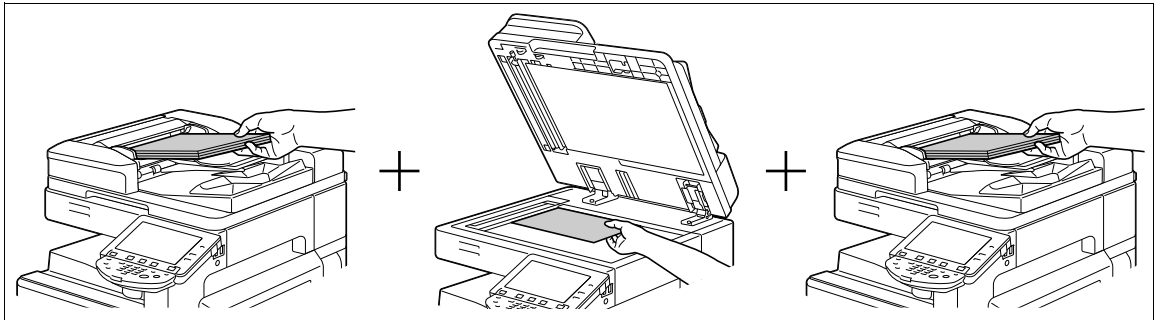

- ✓ Do not load original sheets beyond the upper limit for the **ADF**. It would cause jamming and/or spoiling of the original or failure of the machine.
- ✓ When making 2-sided or combined copies using the **Original Glass**, the machine can scan a number of original pages without enabling Separate Scan.

- 1 Load the original.
- 2 Press [Basic] ►► [Separate Scan].
- 3 Press the **Start** key.
The original is scanned.
- 4 Load the next batch of the original, and then press the **Start** key.
→ To change the scanning settings, press [Change Setting].

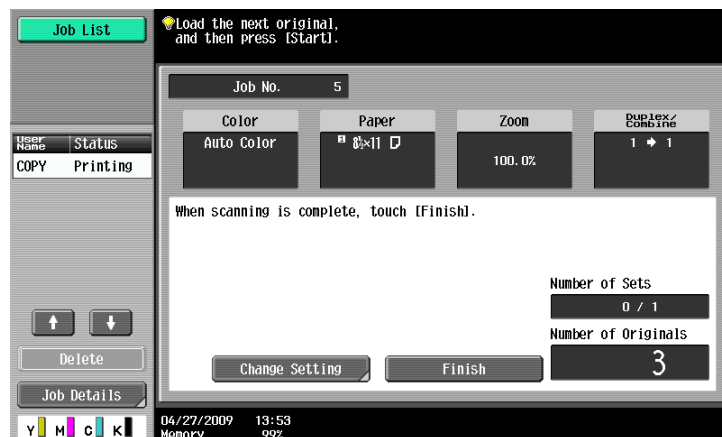

- 5 Repeat Step 4 until all pages of the original are scanned.
- 6 After all original pages have been scanned, press [Finish].
- 7 Press the **Start** key.



Reference

To set the Separate Scan output method:

Press the **Utility/Counter** key ►► [User Settings] ►► [Copier Settings] ►► [Separate Scan Output Method].

5.1.7 [Auto Rotate OFF]

Select this setting to copy the original according to the paper orientation without rotating the image.

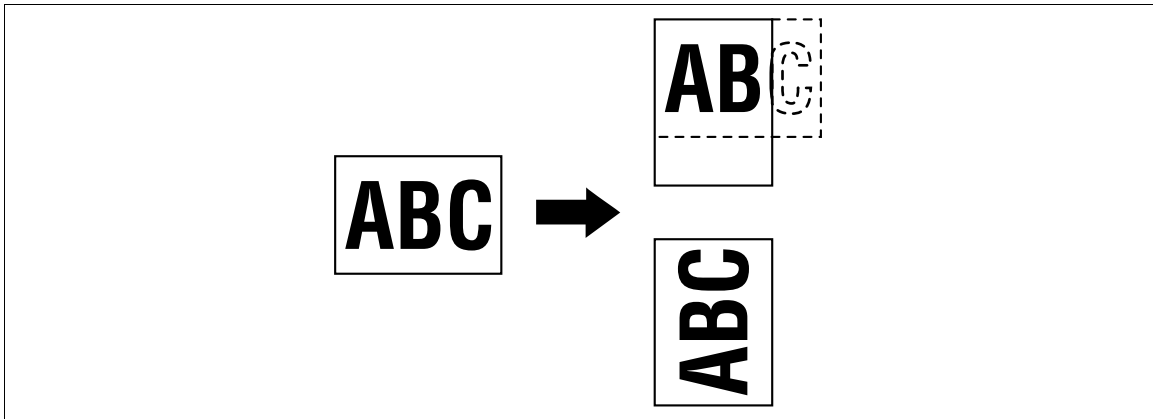

✓ For some paper sizes or zoom values, part of the image may be cut off.

➔ Press [Basic] ►► [Auto Rotate OFF].

5.2 [Original Setting]

Configure the original status or original direction for outputting desired copies.

→ Press [Original Setting].

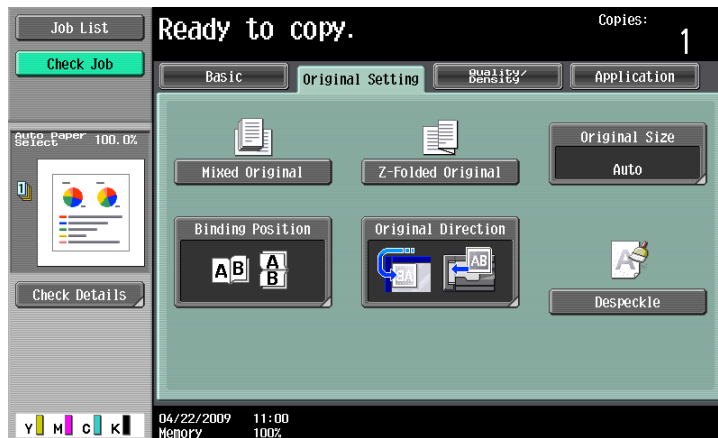

Settings

[Mixed Original]	Loads originals of different sizes into the ADF and scan them at a time.	
[Z-Folded Original]	Correctly detects the original size when folded originals are loaded into the ADF and copied.	
[Original Size]	Select [Auto] to detect the size of the original automatically. If the size of the original is not automatically detected, select the original size.	
	[Custom Size]	Enter the original size.
	[Photo Size]	Select the photo size.
[Binding Position]	Specify the original binding position (page margin) to prevent the copy from being printed upside-down when scanning a 2-sided original.	
	[Auto]	Automatically configures the binding position of the original. <ul style="list-style-type: none"> • A page margin position along the long side of the paper is selected if the original length is 11-11/16 inches (297 mm) or less. • A page margin along the short side of the paper is selected if the original length exceeds 11-11/16 inches (297 mm).
[Original Direction]	When copying double-sided originals or making double-sided or combined copies, press this button to specify the direction in which the original is loaded into the ADF or placed on the Original Glass .	
[Despeckle]	Reduces the influence of a dirt of the Slit Scan Glass upon a copy output when loading an original in the ADF .	

Copying mixed originals

Loads originals of different sizes into the **ADF** and scan them at a time.

To copy onto the same size as the original, select [Full Size] in [Zoom] and select [Auto] in [Paper]. To copy all original pages on paper of the same size, select [Auto] in [Zoom], and select the desired paper size in [Paper].

- ✓ When [1-Sided > 2-Sided] is selected together with Auto Paper, the back side becomes blank if its paper size is different from that of the front side. For example, if a single-sided original is copied in the order of 11 × 17 (A3) and 8-1/2 × 11 (A4), it results in copying of the front side (11 × 17 (A3)) / back side (blank) and of the front side (8-1/2 × 11 (A4)) / back side (blank).

NOTICE

Load all of the original pages into the **ADF** so that the top of the pages is toward the back or the left side of the machine.

- 1 Slide the adjustable **Lateral Guide** of the **ADF** to fit the size of the largest original page.
- 2 Arrange originals in the order you want them to be scanned and load them face up in the **ADF**.
- 3 Press [Original Setting].
- 4 Press [Mixed Original].
 - To cancel the setting, press [Mixed Original] again to deselect it.

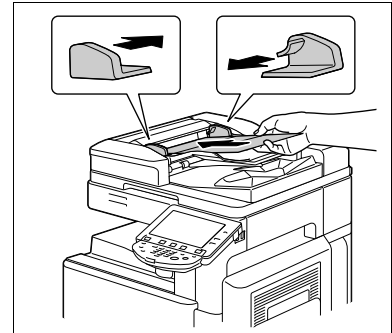

The following chart shows the possible combinations of standard-sized paper that can be used for the Mixed Original setting.

Original Size	Maximum Original Width							
	11 × 17 ☐ (A3☐)	8-1/2 × 11 ☐ (A4☐)	8-1/2 × 14 ☐ (B4☐)	8-1/2 × 11 ☐ (A4☐)	5-1/2 × 8-1/2 ☐ (A5 ☐)	5-1/2 × 8-1/2 ☐ (A5 ☐)	(B5 ☐)	(B5 ☐)
11 × 17 ☐ (A3☐)	○	○	–	–	–	–	–	–
8-1/2 × 11 ☐ (A4☐)	○	○	–	–	–	–	–	–
8-1/2 × 14 ☐ (B4☐)	○	○	○	–	–	–	○	–
8-1/2 × 11 ☐ (A4☐)	○	○	○	○	○	–	○	–
5-1/2 × 8-1/2 ☐ (A5 ☐)	–	–	○	○	○	–	○	–
5-1/2 × 8-1/2 ☐ (A5 ☐)	–	–	–	–	–	○	–	○
(B5 ☐)	○	○	○	–	–	–	○	–
(B5 ☐)	–	–	○	○	○	○	○	○

- Possible to combine
- Not possible to combine

Copying Z-folded originals

Correctly detects the original size when folded originals are loaded into the **ADF** and copied.

The length of the first page of the original is detected, and the subsequent pages are scanned as pages of the same size.

NOTICE

*Unfold folded originals before loading them into the **ADF**. If the original is copied without being unfolded, a paper jam may occur.*

- 1** Load the original into the **ADF**.
- 2** Press [Original Setting].
- 3** Press [Z-Folded Original].
 - To cancel the setting, press [Z-Folded Original] again to deselect it.

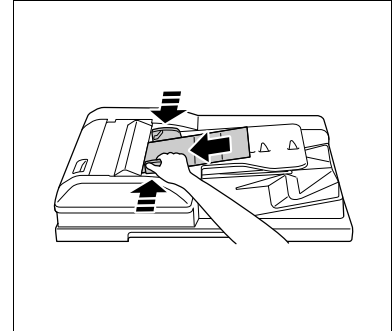







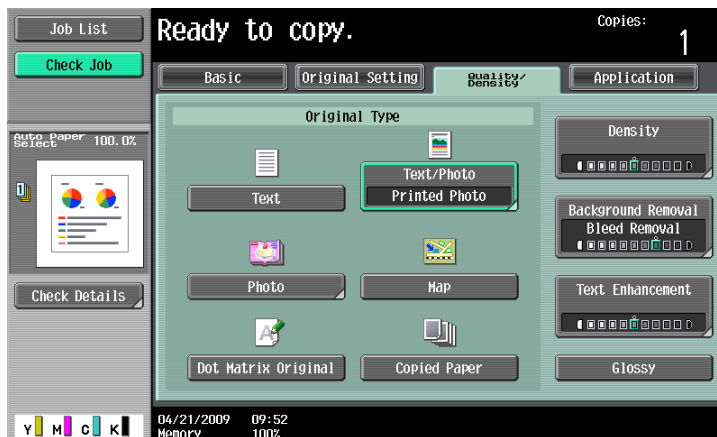



5.3 [Quality/Density]

Select the setting for the image type of the original to better adjust the copy quality/density.

→ Press [Quality/Density].



Settings

[Original Type]	Select the original type (text and image type) to obtain better copy quality.
[Text] 	Copies originals containing only text. The edges of copied text are reproduced with sharpness, providing an image that is easy to read.
[Text/Photo] 	[Photo Paper]: Select this setting to print photos from originals containing both text and images onto photographic paper. A smooth copy image is produced.  [Printed Photo]: Select this setting to copy printed originals containing both text and images, such as pamphlets or catalogs. 
[Photo] 	[Photo Paper]: Select this setting when the original photos are printed on photographic paper. Select this setting to produce better reproductions of halftone original images (photographs, etc.) that cannot be reproduced with the usual settings. A smooth copy image is produced.  [Printed Photo]: Select this setting to copy printed originals, such as pamphlets or catalogs. Halftone original images (photographs, etc.) that cannot be reproduced with the usual settings will be reproduced in as nearly an original state as possible. 
[Map] 	Select this setting when copying originals with a background color or originals containing pencil markings or fine colored lines such as maps. A sharp copy image is produced.
[Dot Matrix Original] 	Select this setting when copying originals containing only text that appears faint (such as that written with a pencil). The copied text is reproduced so that it is darker, making it easier to read.
[Copied Paper] 	Select this setting to copy images (originals) printed using this machine.
[Density]	Adjust copy density.
[Background Removal]	Adjust the density of the background area for originals with colored background (newsprints, recycle paper, etc.) or originals on thin paper showing text or images from the back. Select [Auto] for [Background Removal Level] to enable automatic background density adjustment for copying with the optimal background density. For [Background Removal], normally [Bleed Removal] is selected. However, when copying an original with colored background, select [Paper Discoloration Adj] to make adjustment for background removal for copying.

Settings

[Text Enhancement]	Adjust the text reproduction level for an original with a photo overlapping the text (background text) to clarify the text on the background. To emphasize the text on the background, press [Darker Text] to adjust the setting toward +. To emphasize the background image, press [Lighter Text] to adjust the setting toward -. [Text Enhancement] can be configured when an item other than [Photo] is selected.
[Glossy]	Makes copies with a glossy finish.

5.4 [Application]

Configure the application settings for making copies.

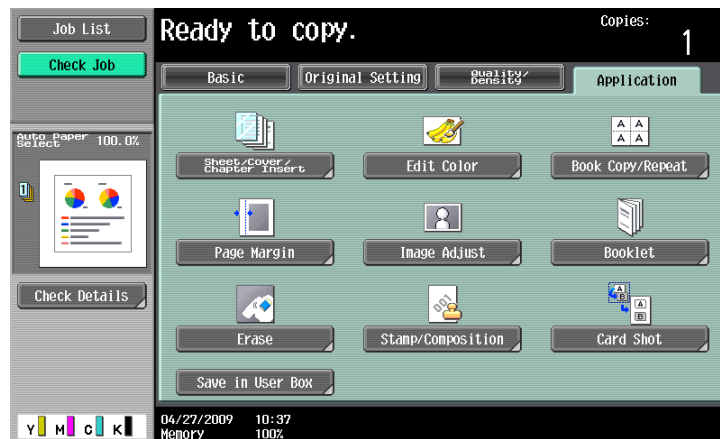

Item		
[Sheet/Cover/Chapter Insert]	Inserts another sheet of paper or adds a cover page to the paper for copying. You can also scan multiple copies of the original with different settings.	p. 5-23
[Edit Color]	Inverts the contrast or gradation of the original or prints the original in the mirror image. It also adds a color in the background or adjust the quality of a color image.	p. 5-30
[Book Copy/Repeat]	Configure the settings for a book or catalog. An image on a single sheet of original can be repeatedly copied or divided and enlarged in parts to produce copies of the respective parts.	p. 5-35
[Page Margin]	Select the binding margin (blank area) of the paper used for copying.	p. 5-40
[Image Adjust]	Configure the layout for the image when the paper is larger than the original.	p. 5-41
[Booklet]	Automatically arranges the page order of the scanned original and makes 2-sided 2 in 1 copies to produce a page layout for a center-bound book, such as a magazine.	p. 5-43
[Erase]	Erases unnecessary outside portion of the original body text or erases the area outside the original placed on the Original Glass .	p. 5-44
[Stamp/Composition]	Prints the date/time, page number or a stamp printed on copies. This function also allows you to embed information for preventing unauthorized copying in a document.	p. 5-46
[Card Shot]	Copies the contents of the front and back sides of a card-size original, for example, insurance card, driver's license, or business card, on one sheet.	p. 5-60
[Save in User Box]	Saves the scanned original data in a User Box.	p. 5-61

5.4.1 [Sheet/Cover/Chapter Insert]

[OHP Interleave]

Prevent copies printed onto OHP transparencies from sticking together because of the heat produced during copying by having paper (interleaves) inserted between the transparencies.

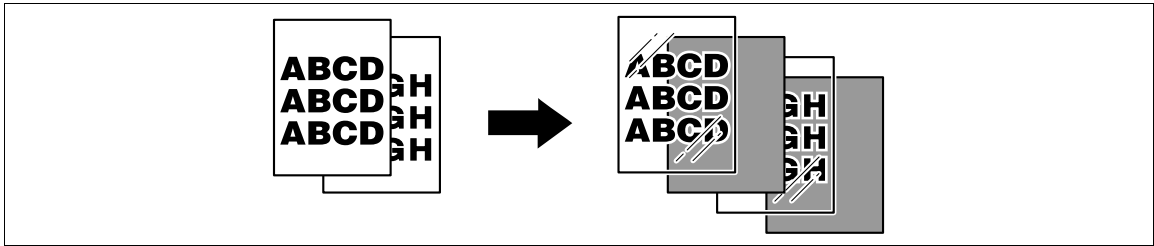

- ✓ Printing on OHP transparencies is possible only in black.
- ✓ Use interleaf paper with the same size as the OHP transparencies.
- ✓ The number of copies is fixed to one. The number value cannot be changed.
- ✓ The finishing function cannot be changed.
- ✓ Load transparencies into the **Bypass Tray**.
- ✓ Do not use a transparency that has been through the machine even once. It may lead to reduced print quality, a paper jam or a damage to the machine. (Even if a transparency has been discharged without printing, it cannot be reused.)

- 1 Load the original.
- 2 Press [Basic] ►► [Color] ►► [Black].
- 3 Load transparencies into the **Bypass Tray**. Load the interleave paper into the desired paper tray.
- 4 Set the [Paper Type] of the **Bypass Tray** to [Transparency] and press [OK].
- 5 Press [Application] ►► [Sheet/Cover/Chapter Insert] ►► [OHP Interleave].

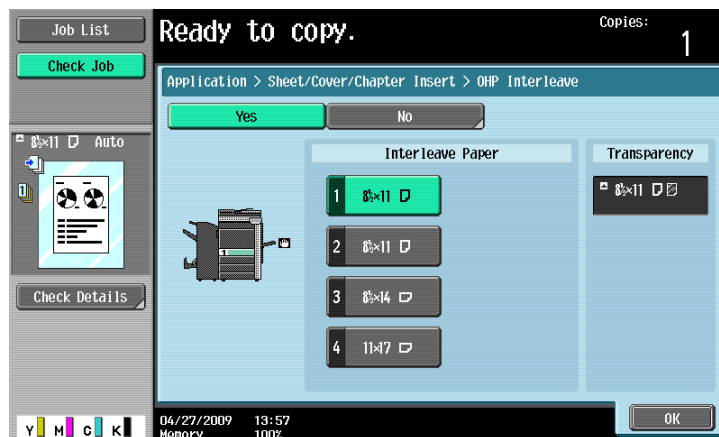
**Settings**

[Interleave Paper]	Select the paper tray loaded with paper with a transparency interleaf.
[Transparency]	Indicates the paper size of the loaded transparency.

**Reference**

Setting Black for Color Settings:

Press [Basic] ►► [Color] ►► [Black].

[Cover Sheet]

Copies the front and back cover sheets onto separate paper when copying an original with a front/back cover sheet. When the original to copy does not have a front and back cover, you can insert blank sheets of paper as the front and back covers.

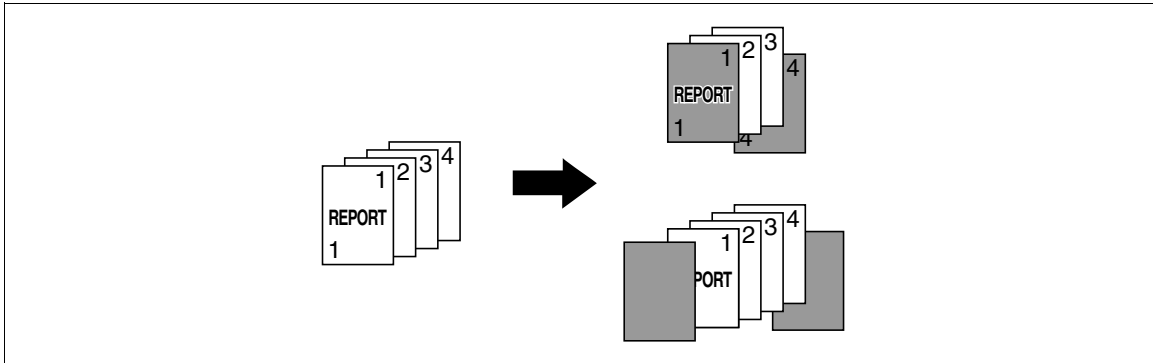

- ✓ Use paper of the same size for the body text and cover sheets, and ensure the same orientation of paper for both purposes.
- ➔ Press [Application] ►► [Sheet/Cover/Chapter Insert] ►► [Cover Sheet].

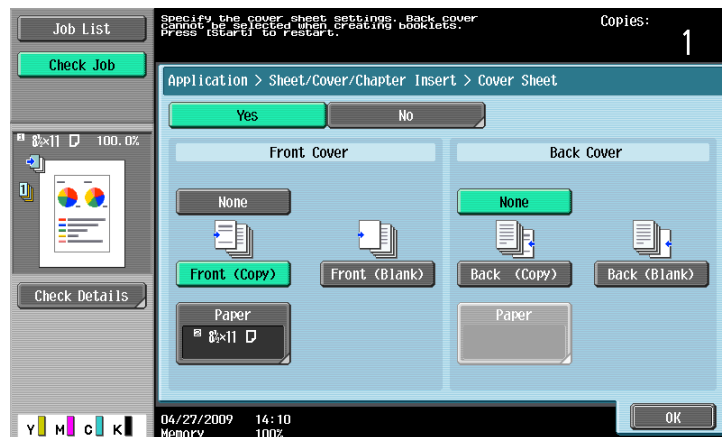

Settings

[None]	Disables copying of the front/back cover and blank sheet insertion.
[Front (Copy)]	For 1-sided copy: Copies the first page of the original onto paper for the front cover sheet. For 2-sided copy: Copies the second page of the original onto the back of the paper for the front cover sheet.
[Front (Blank)]	Adds paper for the front cover sheet as the first page of the copy.
[Back (Copy)]	For 1-sided copy: Copies the last page of the original onto the back cover page. For 2-sided copy: Copies the last two pages of the original the 2-sided copy mode onto both sides of the paper for the back cover when copying an original with an even number of pages.
[Back (Blank)]	Add paper for the back cover sheet to the last page of the copy.
[Paper]	Select the paper tray loaded with the paper for the front/back cover page or blank cover pages.



Reference

To configure the 2-sided copy mode:

Press [Basic] ►► [Duplex/Combine].

[Insert Sheet]

A different sheet of paper (such as colored paper) can be inserted as specified pages in the copies. You can select from two options: [Copy] and [Blank] to enable or disable copying to the inserted sheet.

- ✓ You can specify up to 30 positions for insert sheets.
- ✓ Use paper of the same size for the sheets to be inserted and for the original copies, and ensure the same orientation of paper for both.

➔ Press [Application] ➤ [Sheet/Cover/Chapter Insert] ➤ [Insert Sheet].

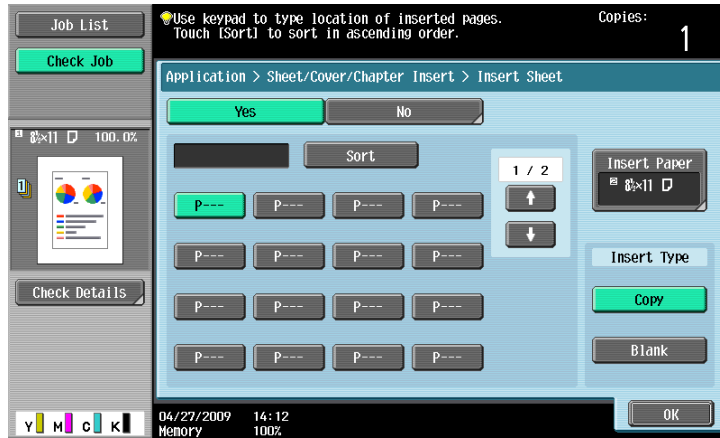

Settings

[P---]	Specify where to insert sheets of a different paper type.
[Sort]	Sorts specified pages in the ascending order.
[Insert Paper]	Select the paper tray loaded with the paper to be inserted.
[Copy]	<p>Copies the original with the specified paper inserted for the specified pages. When setting the specified page to "2"</p> <p>For 1-sided copy: Inserts the specified paper as the second page of the copies, and copies the second page of the original onto it.</p> <p>For 2-sided copy: Leaves the back side of the first page of the copy blank, inserts the specified paper for the second page of the copy, and makes a 2-sided copy of the second and third pages of the original onto the inserted sheet.</p>
[Blank]	<p>Select this option to insert the specified paper sheet after the page you have specified. When setting the specified page to "3"</p> <p>For 1-sided copy: Inserts the specified paper as the fourth page of the copy.</p> <p>For 2-sided copy: Leaves the back side of the second page of the copy blank, and inserts the specified paper for the third page of the copy.</p>



Reference

To configure the 2-sided copy mode:

Press [Basic] ►► [Duplex/Combine].

[Insert Image]

A multi-page original scanned on the **Original Glass** can be inserted at the pre-set location in an original first scanned with the **ADF**.

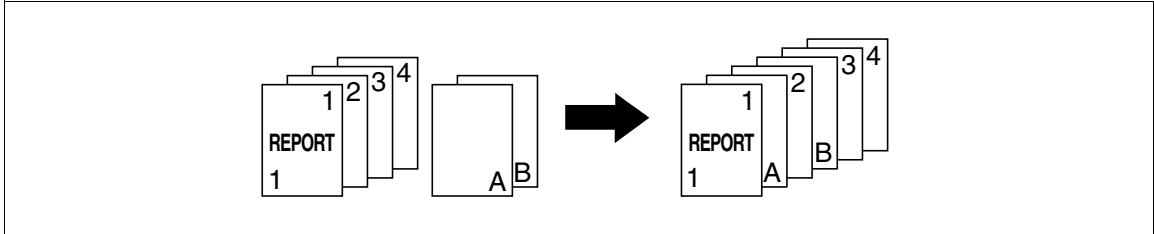

- ✓ With the Insert Image function, the inserted original is added after the specified page.
- ✓ You can specify up to 30 positions for the original to be inserted.
- ✓ If the original scanned on the **Original Glass** has more pages than the number of pages specified in the Insert Image screen, the remaining pages of the inserted original are printed at the end of the original.
- ✓ The original on the **Original Glass** is scanned with the same settings as for the original scanned in the **ADF**.
- ✓ If the original scanned on the **Original Glass** has fewer pages than the number of pages specified in the Insert Image screen, the missing insertion pages will not be printed.
- ✓ If the same page number is specified twice, two insertion original pages are added at the specified location.
- ✓ If the specified page number is greater than the total number of pages in the main original, the corresponding insertion original page is added at the end of the copy.

- 1 Load the original into the **ADF**.
- 2 Press [Application] ►► [Sheet/Cover/Chapter Insert] ►► [Insert Image].

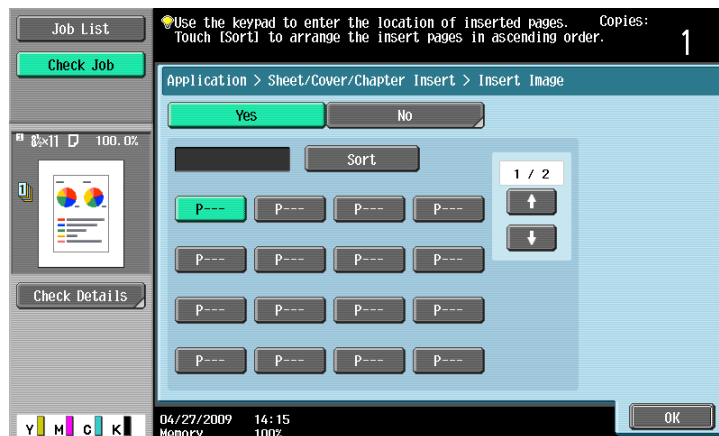

Settings

[P---	Specify the position to insert the page scanned through the Original Glass .
[Sort]	Sorts specified pages in the ascending order.

- 3 Press the **Start** key.
- 4 Place the original to be inserted on the **Original Glass**.

5 Press the **Start** key.

→ To insert a multi-page original, repeat steps 4 and 5 until all pages of the insertion original are scanned in the order that they are to be inserted.

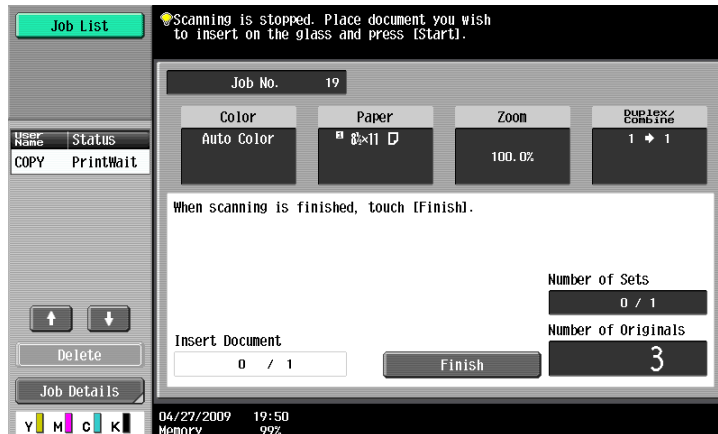

6 Press [Finish].

7 Press the **Start** key.
Copying begins.

[Chapters]

When making 2-sided copies, the pages specified as the first page of a chapter can be printed on the front side of the paper. If the document was arranged so that the specified page would be printed on the back side of a page, the page is left blank and the specified page is printed on the front side of the next page.

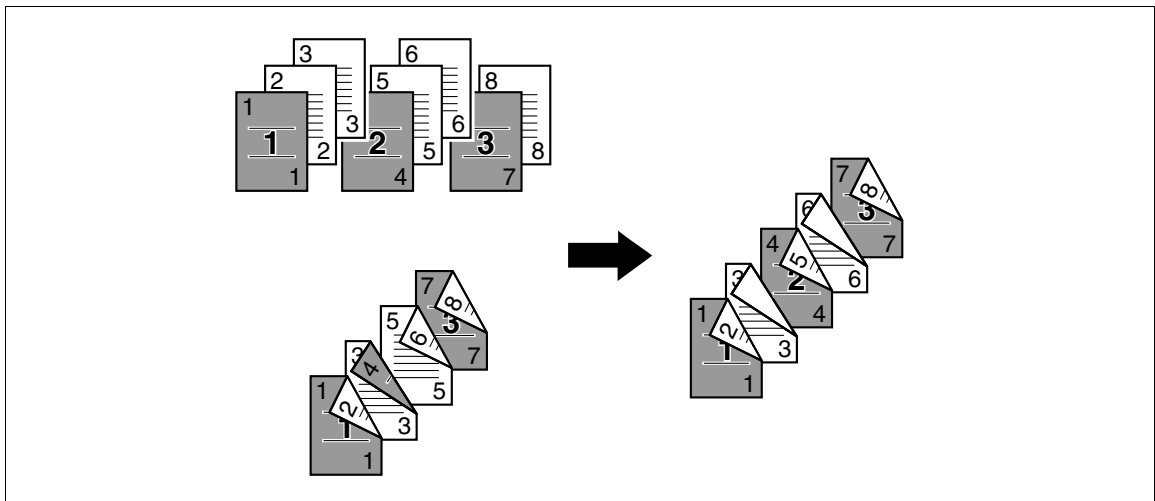

- ✓ You can set up to 30 positions for the first page of chapters.
- ✓ Enable the Chapters function to set [1-Sided > 2-Sided]. For a 2-sided original, select [2-Sided > 2-Sided].
- ✓ Make sure that the paper loaded for the first page of the chapter and for text copies have the same size and orientation.

→ Press [Application] ►► [Sheet/Cover/Chapter Insert] ►► [Chapters].

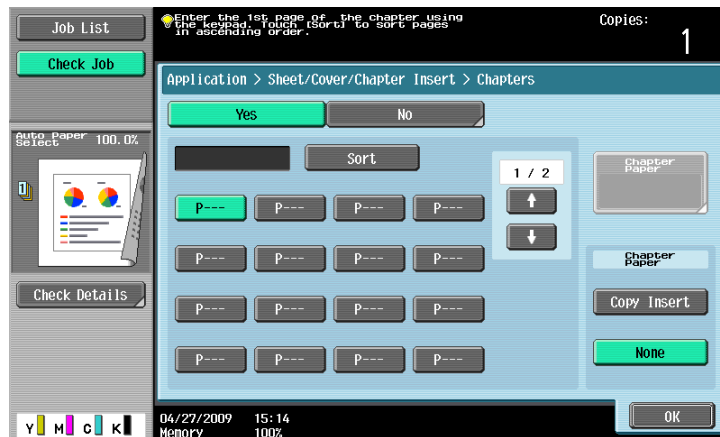

Settings

[P---	Specify the first page of the chapters.
[Sort]	Sorts specified pages in the ascending order.
[Chapter Paper]	Specify the paper tray for paper to be inserted for the first page of the chapter.
[Copy Insert]	Makes copies of the first pages of the chapters on paper of a different type from that for the text pages.
[None]	Copies all pages with the same type of paper.



Reference

To configure the 2-sided copy mode:

Press [Basic] ►► [Duplex/Combine].

[Program Jobs]

When the originals to be copied include different types of materials such as a 1-sided original for full size copying and a 2-sided original for enlarged copying among other things, you can use this setting for scanning various originals with different settings and then copy them all in a single copying job.

Different Zoom or Paper settings can be specified for a part of the original or Finishing settings or a numbering function can be set after the entire original is scanned, and then all copies can be printed together.

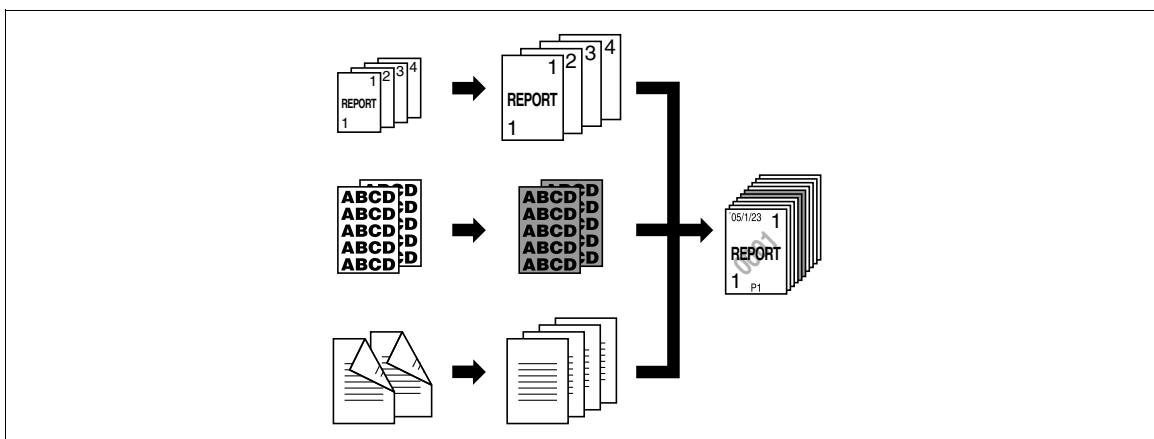

- ✓ Up to 100 types of originals can be scanned.
- ✓ When configuring a program job, the [Group] setting cannot be selected in the Finishing screen. Instead, select [Sort].

- 1 Press [Application] ►► [Sheet/Cover/Chapter Insert] ►► [Program Jobs].
- 2 Select the desired copy settings, and then press the **Start** key.
- 3 Press [Fix].
 - Press [Retry] to delete the scanned job. Press [Change Setting] to configure the copy settings.
 - When the original has been loaded on the original glass, press [Finish].

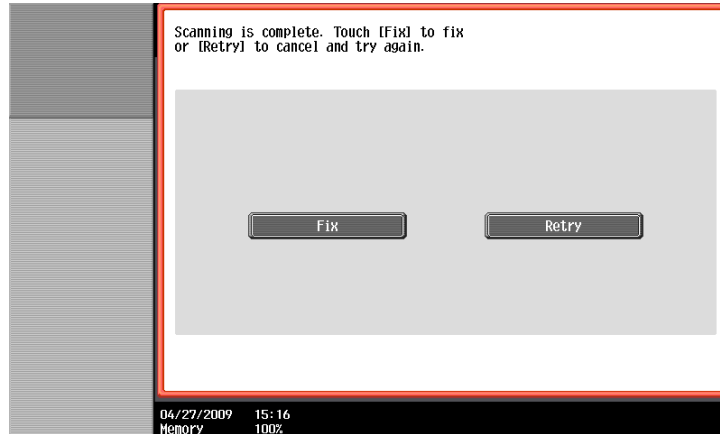

- 4 Load the next original and press [Change Setting].
- 5 Select the desired copy settings, and then press the **Start** key.
 - Repeat Steps 3 to 5 until all originals have been scanned.

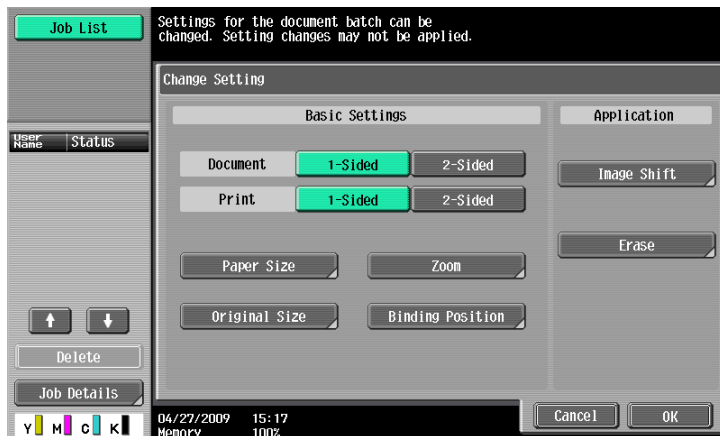

- 6 After all original pages have been scanned, press [Finish].
- 7 Press [Yes].

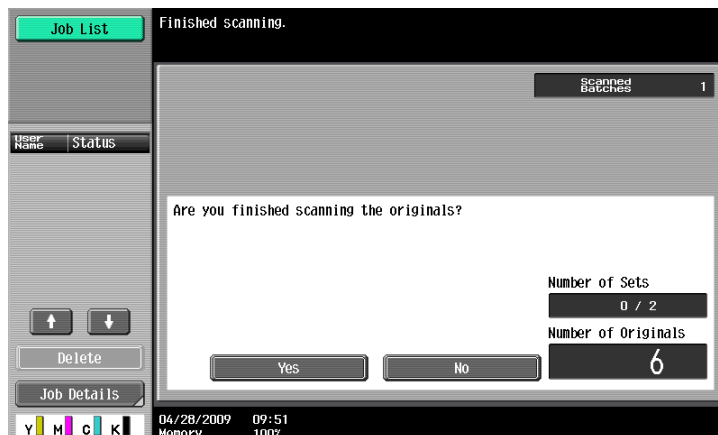

- 8 Specify finish settings as needed.

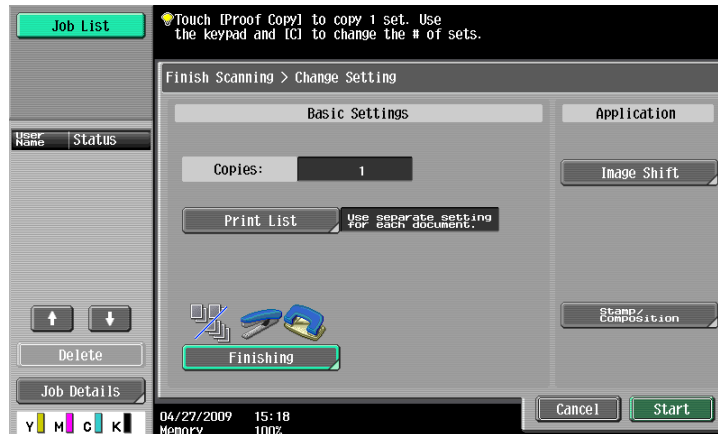

- 9 Press [Start] or the **Start** key.

5.4.2 [Edit Color]

[Neg./Pos. Reverse]

Use this function to enable the original to be copied with the density and gradations of the image inverted. The images in the original are copied and output reversed like negative film of photographs.

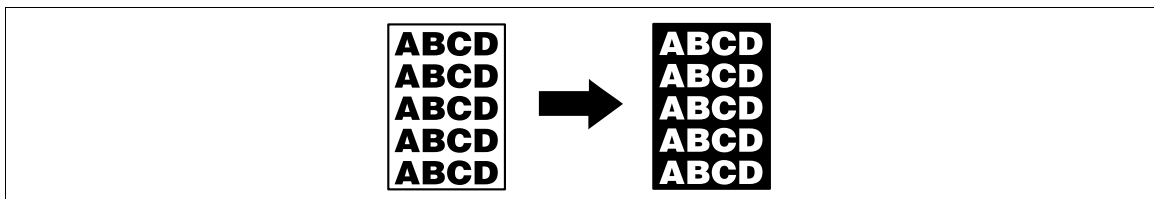

- ✓ If a single color is selected, the images are reversed relative to the selected color.
 - ✓ If a background color is selected, colors are reversed relative to the selected base color and the color of the images.
- Press [Application] ►► [Edit Color] ►► [Neg./Pos. Reverse].
- To cancel the Neg./Pos. Reverse function, press [Neg./Pos. Reverse] again.

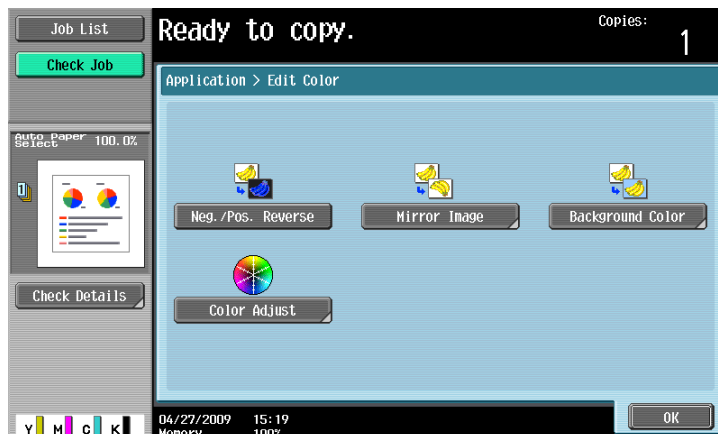

**Reference**

To set Single Color:

Press [Basic] ▶▶ [Color] ▶▶ [Single Color].

To Set Background Color:

Press [Application] ▶▶ [Edit Color] ▶▶ [Background Color].

[Mirror Image]

Copy originals as mirror images.

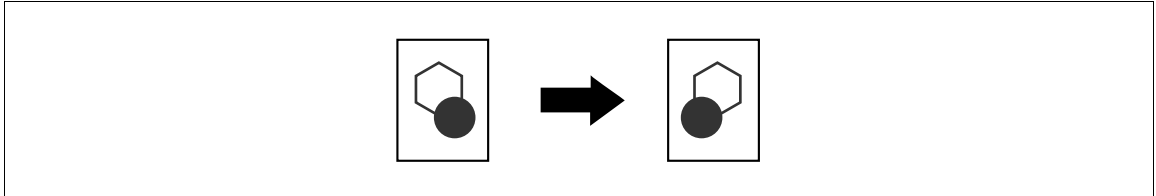

→ Press [Application] ▶▶ [Edit Color] ▶▶ [Mirror Image].

**Settings**

[Original Size]	Select [Auto] to detect the size of the original automatically. If the size of the original is not automatically detected, select the original size.	
	[Custom Size]	Enter the original size.
	[Photo Size]	Select the photo size.

[Background Color]

Color the blank area of the original with a specified background color.

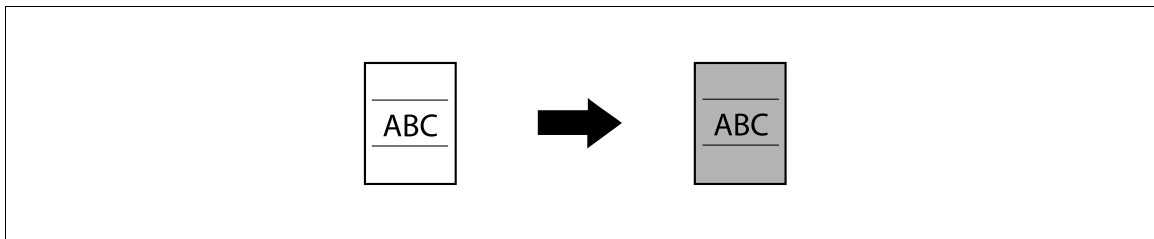

→ Press [Application] ►► [Edit Color] ►► [Background Color].

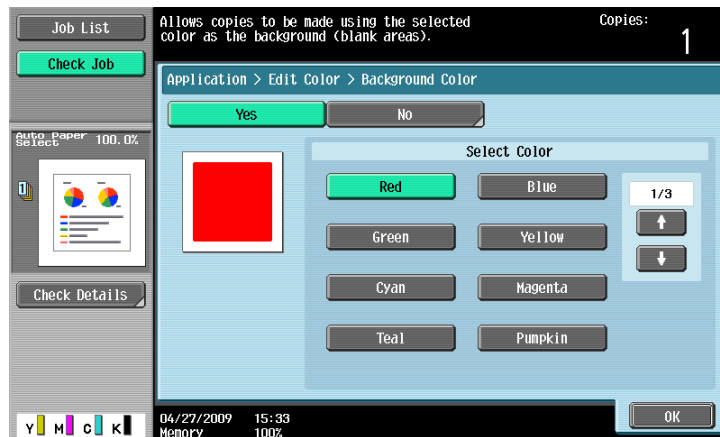

Settings

[Select Color]

Select a background color.

[Color Adjust]

Adjusts the image quality to fit an image based on the color-copied original.

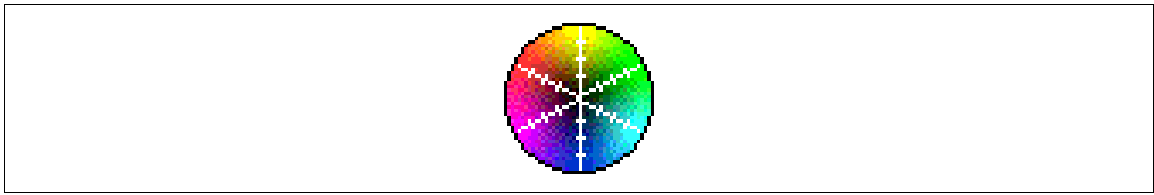

- 1 Press [Application] ►► [Edit Color] ►► [Color Adjust].



Settings

[Brightness]	Adjust the brightness of the copied image.
[Contrast]	Adjust the copy density balance.
[Saturation]	Adjust how vivid colors should be for full color copies.
[Red]	Adjust how vivid red colors should be for full color copies.
[Green]	Adjust how vivid green colors should be for full color copies.
[Blue]	Adjust how vivid blue colors should be for full color copies.
[Hue]	Adjust the hue for full color copies. The hue refers to a color trend relative to discrete colors such as red, blue and yellow. By adjusting the hue, the image can attain more red-dish or bluish tone, for example.
[Copy Density]	Adjust copy density (lighter or darker).
[Sharpness]	Adjust the sharpness to emphasize the edges of text so that copied text can be read more easily. You can make an overly sharp original image softer or a blurry image clearer.
[Color Balance]	Adjust the individual concentrations of yellow (Y), magenta (M), cyan (C), and black (K) for full-color copies. Full-color copy reproduces colors of the original by mixing toners of four colors: yellow, magenta, cyan, and black. By changing the amount of each of the four toners, adjust the tints in the copy.

2 Configure respective functions.

- Press [Sample Copy] to see how it will appear with the currently specified color quality adjustment settings.

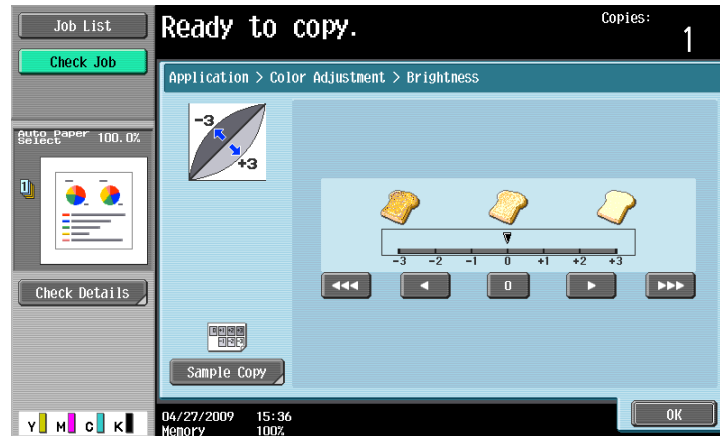

5.4.3 [Book Copy/Repeat]

[Book Copy]

Divides or does not divide page spreads (such as a book or catalog) into left and right pages to copy data.

This function enables copying with the ADF open by placing the original on the Original Glass. If necessary, you can place an original image at the center of the paper to copy.

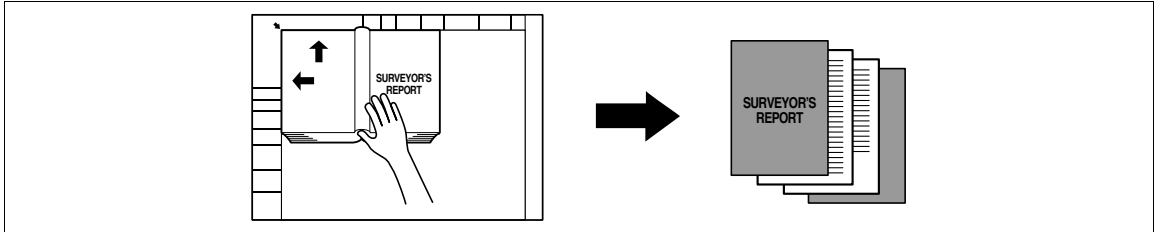

- ✓ Place the original on the **Original Glass**.
- ✓ If [Book Copy] is selected, [Image Adjust] is set to [Centering] and [Erase] is set to [Non-Image Area Erase] automatically. For details on [Centering], refer to page 5-41. For details on [Non-Image Area Erase], refer to page 5-45. The automatically set [Centering] or [Non-Image Area Erase] can be cancelled.
- ✓ When [Book Spread] or [Separation] is selected, pressing the **Start** key starts printing.
- ✓ When [Front and Back Cover] is selected, the scanning operation starts with the front cover followed by scanning of the back cover, and ends with scanning of all two-page spreads of the body text in the order of the page numbers.
- ✓ When [Front Cover] is selected, all two-page spreads are scanned in order after the front cover.
- ✓ When [Front and Back Cover] or [Front Cover] is selected, wait until all pages in the original are scanned and then press [Finish] and then the **Start** key to start printing.

➔ Press [Application] ►► [Book Copy/Repeat] ►► [Book Copy].

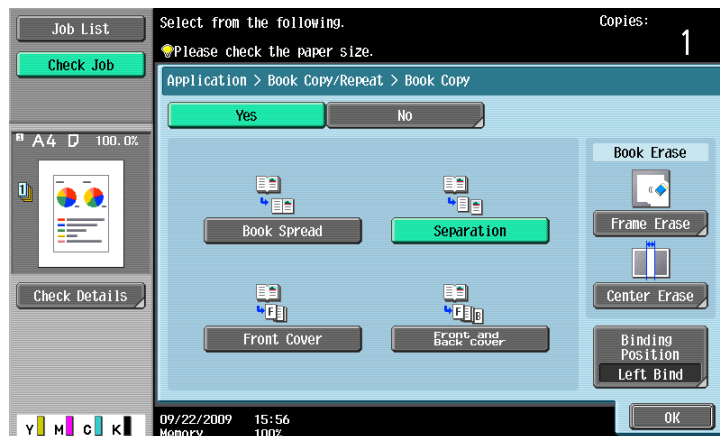

Settings

[Book Spread]	Copies both pages of a two-page spread original as a one page original.
[Separation]	Copies the right and left pages of two-page spreads separately in the order of the page numbers.
[Front Cover]	Copies the front cover, the right and left pages of two-page spreads separately in the order of the page numbers, and the back cover in this order.
[Front and Back Cover]	Copies the front cover, separate copies of each page in the page spreads and the back cover in the original page order.

Settings

[Frame Erase]	Erases projection of the dark shadow around the book.	
	[Frame]	Configure the width of the area around the entire frame to be erased.
	[Top],[Right], [Bottom], [Left]	Configure the width of the top, right side, bottom and left side of the frame to be erased.
	[None]	Select this settings to not erase the frame.
[Center Erase]	Erases projection of the dark shadow at the center of the book.	
[Binding Position]	Select the binding position of the original. To indicate it, select [Separation], [Front Cover], and [Front and Back Cover].	

[Image Repeat]

An original image can be repeatedly printed on a single sheet of paper. Specify the original and paper sizes or the zoom to automatically calculate the number of images to be copied accordingly. Alternatively, specify the desired number of repetitions.

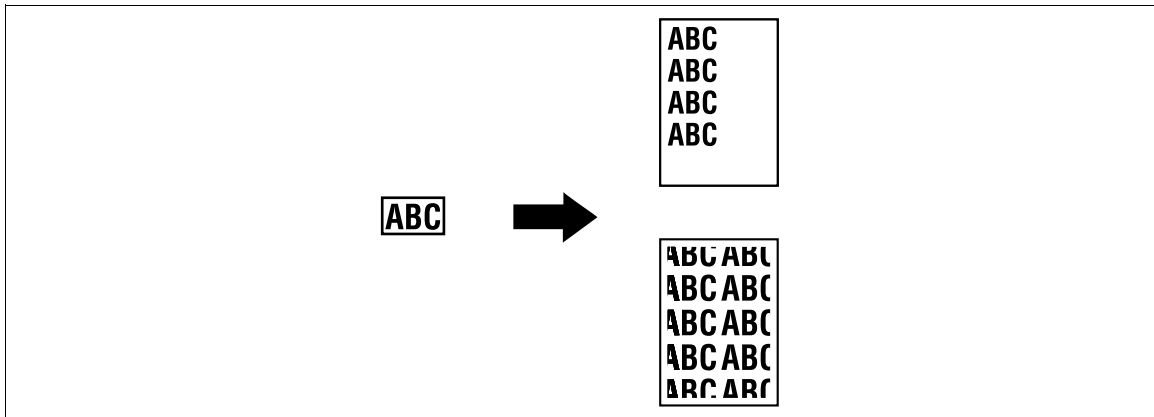

→ Press [Application] ►► [Book Copy/Repeat] ►► [Image Repeat].

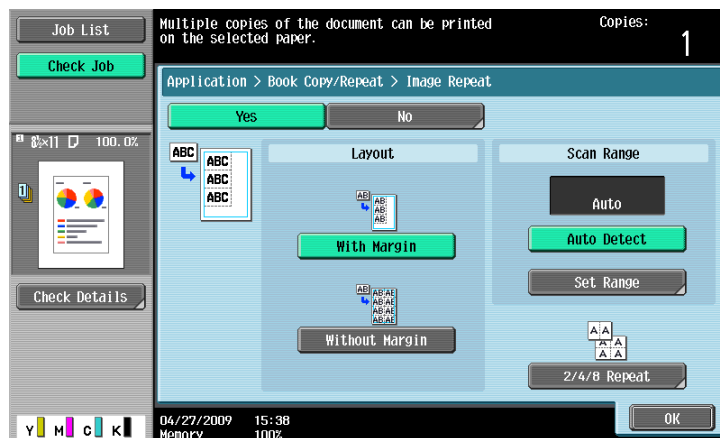

Settings

[With Margin]	Repeats copying of the scanned area of the original so that the copy area of the sheet is filled with the copied image. If the entire image does not fit into the copy area, the extra range is not copied.	
[Without Margin]	Repeats copying of the scanned area of the original so that the sheet is filled with the copied image. However, some parts of the image may be lost.	
[Auto Detect]	Automatically detects the area to be scanned.	
[Set Range]	Select [Auto] to detect the size of the original automatically. If the size of the original is not automatically detected, or the reading range must be specified, select the original size.	
	[Custom Size]	Enter the original size.
	[Photo Size]	Select the photo size.
[2/4/8 Repeat]	[2 Repeat] [4 Repeat] [8 Repeat]	Repeats copying of the scanned area of the original as many times as specified. Note, however, that an image that does not fit within the size of the paper used is copied with partial cutoff. [Repeat Interval Settings] can be configured only for [2 Repeat].
	[Repeat Interval Settings]	Specify the clearance between copied images.

[Poster Mode]

This function enables enlarged of the original image to a size exceeding the paper size that can be loaded in the machine, such as the 33 × 44 (A0) or 24 × 36 (B0) size. Specify the original size and the output size (enlarged copy size) to output enlarged copies of divided sections of the original onto separate sheets of paper respectively. Create an enlarged copy of the specified finished size by joining those copies of sections.

To create a 33 × 44 (A0) size poster, create copies of sections on eight 11 × 17 (A3) size sheets and join them together.

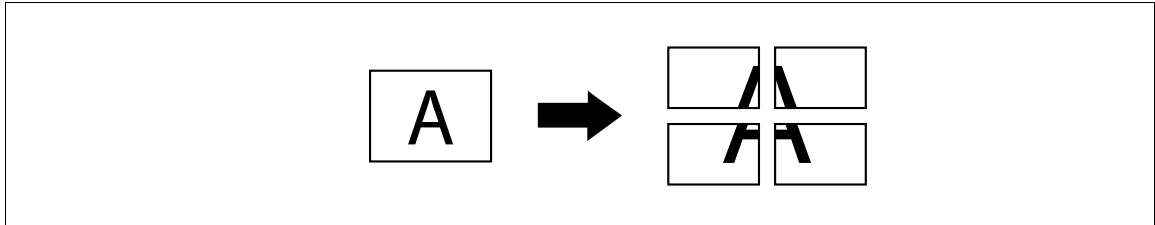

- ✓ Place the original on the **Original Glass**.
 - ✓ In Poster Mode, the number of copies is set to 1.
- Press [Application] ►► [Book Copy/Repeat] ►► [Poster Mode].

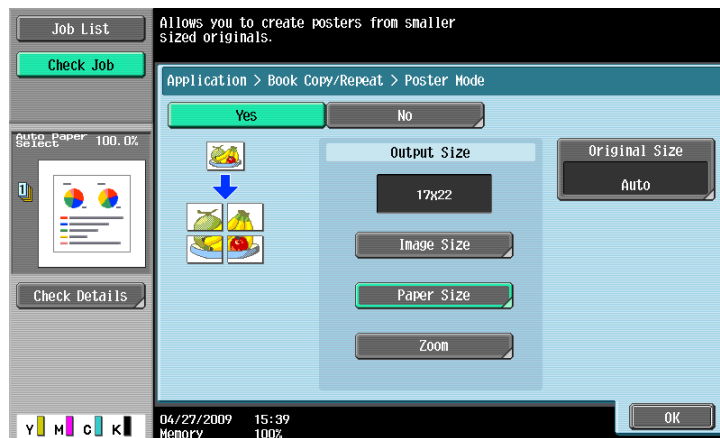

Settings

[Image Size]	Select the finished image size.	
	[Custom Size]	Enter the finished image size.
[Paper Size]	Select the size within which the finished copy is contained.	
[Zoom]	Enter the zoom to output a copy of the finished size.	
[Original Size]	Select [Auto] to detect the size of the original automatically. If the size of the original is not automatically detected, select the original size.	
	[Custom Size]	Enter the original size.
	[Photo Size]	Select the photo size.

[Booklet Original]

A catalog with its staples removed can be copied and bound with staples at the center to create copies of the original catalog.

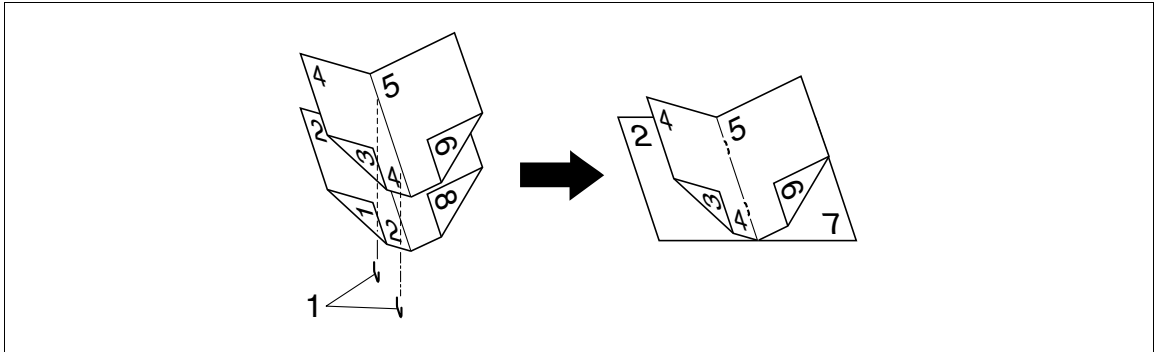

1. Staples

✓ This item is available if the **Saddle Stitcher SD-509** is installed in the optional **Finisher FS-527**.

NOTICE

Load a catalog with the staples removed.

1 Load the original.

→ To use the **Original Glass**, position the pages in order, starting with the side that includes the first page, then the side that includes the second page, then the side that includes the third page.

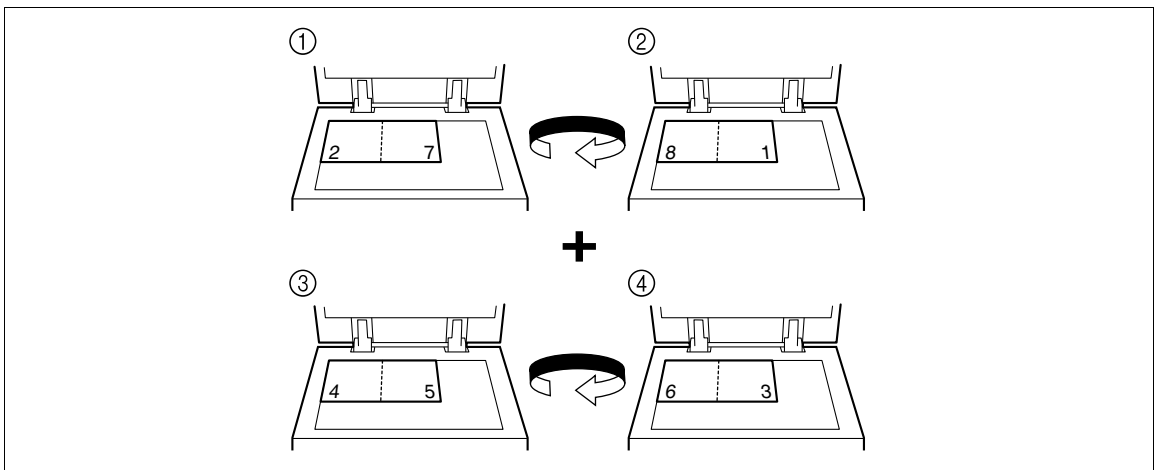

→ To use the **ADF**, load the pages with the side that includes the first page on top.

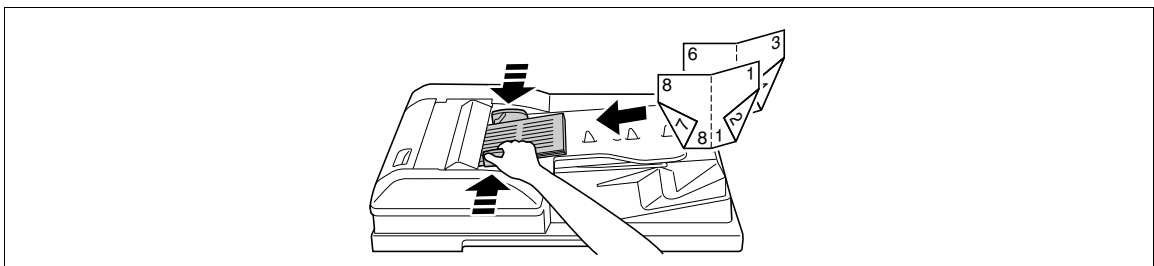

2 Press [Application] ►► [Book Copy/Repeat] ►► [Booklet Original].

3 Press the **Start** key.

4 After all original pages have been scanned, press [Finish] and the **Start** key.

5.4.4 [Page Margin]

Copies can be printed with a binding margin so that the pages can easily be filed. When scanning a 2-sided original, you can specify the paper binding position (binding margin for the paper) to prevent the copy from being printed upside-down.

[Left]

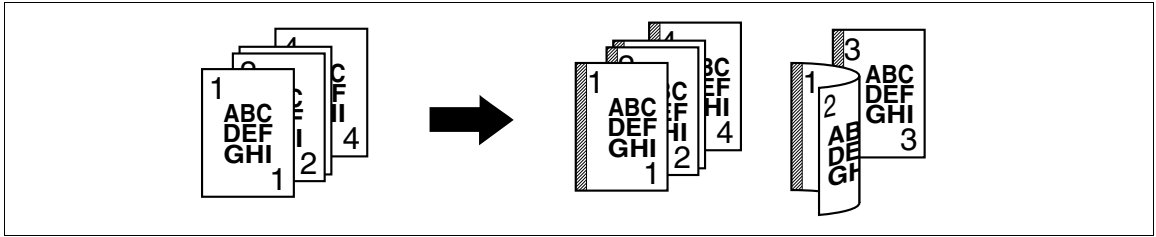

[Top]

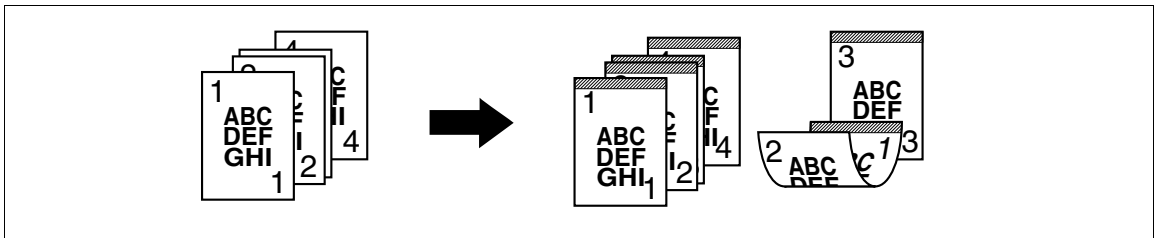

[Right]

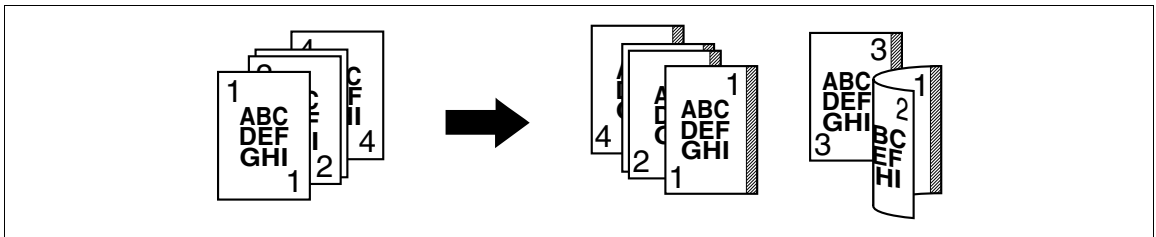

- ✓ You can specify the binding position without creating a binding margin.
- ✓ For 2-sided copy, you need to set the paper binding position and the original direction. Otherwise, the original image may be copied up-side-down.
- ✓ If the positions of the staples or punched holes are different from the binding position, the positions of the staples or punched holes are given priority.
- ✓ If part of the image is lost when copied with the specified binding margin settings, reduce the zoom and perform copying.

➔ Press [Application] ►► [Page Margin].

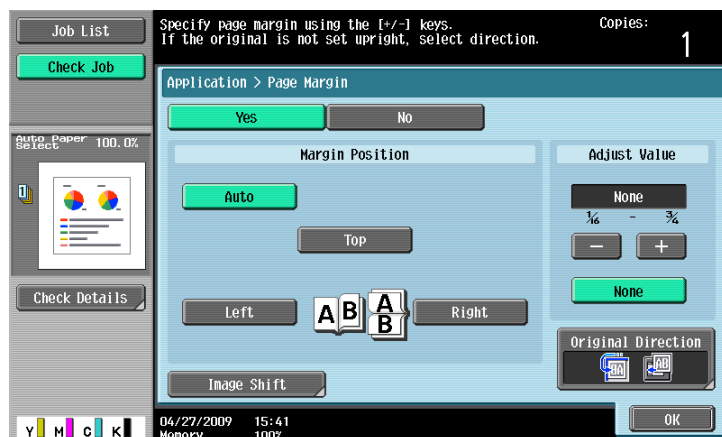

Settings

[Margin Position]	Select an option from [Auto], [Left], [Top] and [Right]. When Auto is selected, the binding position is automatically set. <ul style="list-style-type: none"> • This function automatically determines the binding position according to the orientation of the loaded original. If the original length is 11-11/16 inches (297 mm) or less, a binding position along the long side of the paper is selected. If the original length is more than 11-11/16 inches (297 mm), a binding position along the short side of the paper is selected. • The binding position is set on the upper or left-side end. • Be sure to load the original so that its top side is placed in the back. If the original is loaded in any other orientation, this setting fails. 	
[Image Shift]	Adjust the image position according to the binding margin.	
	[Change Back Shift]	Adjust the image position on the back side of the paper in the 2-sided copy mode.
[Adjust Value]	<ul style="list-style-type: none"> • Inch area: Press [+] or [-] to specify the binding margin width (1/16 to 3/4 inch). When [None] is selected, the binding margin width is set to 0 inches. • Metric area: Enter the binding margin width (0.1 to 20.0 mm). When [None] is selected, the binding margin width is set to 0 mm. 	
[Original Direction]	Select the orientation of the original loaded into the ADF or placed on the Original Glass .	

**Reference**

To set the zoom:

Press [Basic] ➔ [Zoom].

5.4.5 [Image Adjust]

If the paper is larger than the original, you can enlarge the original and copy it into the center of the paper.

[Full Size]

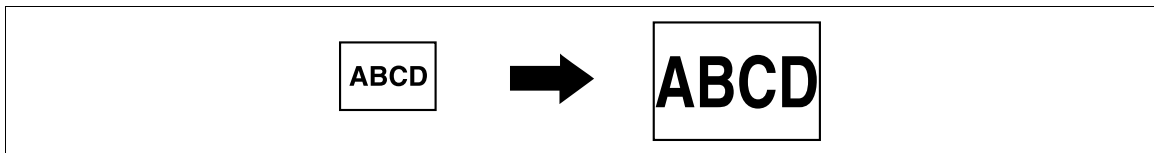

[Center Zoom]

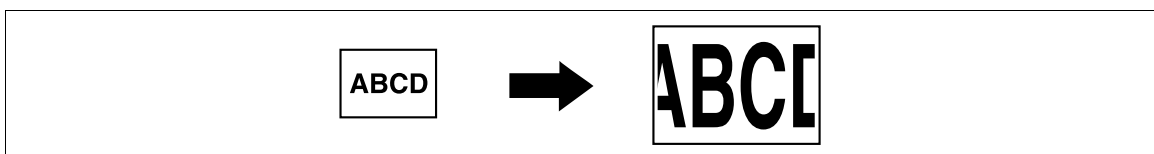

[Centering]

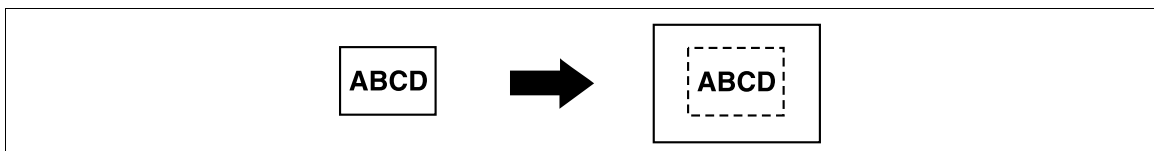

→ Press [Application] ►► [Image Adjust].

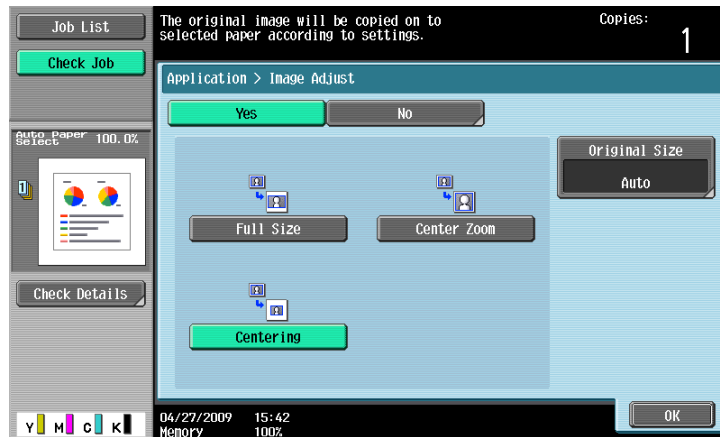

Settings

[Full Size]	Enlarges the image up to the largest possible paper size that can contain the entire original, and copies the image at the center of the paper. Place the original on the Original Glass .	
[Center Zoom]	Enlarges the image up to the largest possible paper size that can contain the entire original, and copies the image at the center of the paper. However, some parts of the image may be lost. Place the original on the Original Glass .	
[Centering]	Copies the original image at the center of the paper without enlarging it.	
[Original Size]	Select [Auto] to detect the size of the original automatically. If the size of the original is not automatically detected, select the original size.	
	[Custom Size]	Enter the original size.
	[Photo Size]	Select the photo size.

5.4.6 [Booklet]

The page order of the scanned original is automatically arranged to produce 2-sided 2 in 1 copies in a page layout for center binding, such as for a magazine.

[Left Bind]

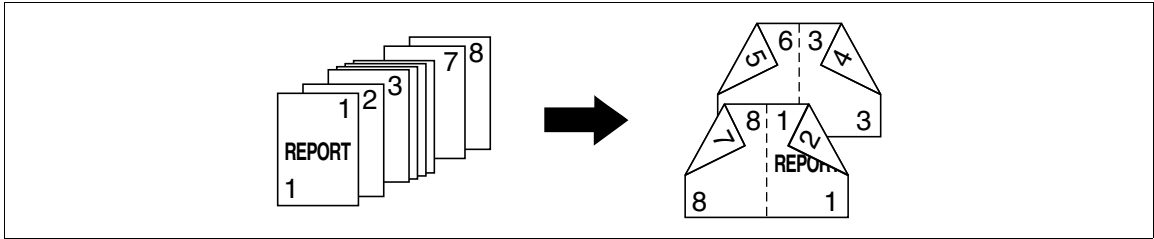

[Right Bind]

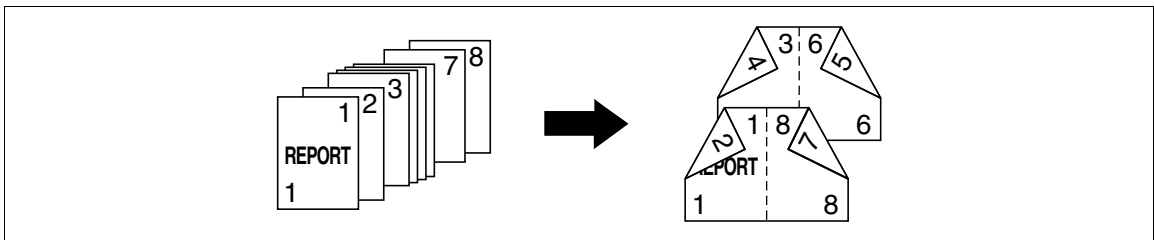

- ✓ Center Staple & Fold or Half-Fold is available if the **Saddle Stitcher SD-509** is installed in the optional **Finisher FS-527**.
- ✓ Generally, a multiple of 4 pages is required with a 1-sided original, and a multiple of 2 pages is required with a 2-sided original. If there are not enough pages, blank pages are automatically added at the end.
- ✓ If a booklet is selected with the Auto Paper Select enabled, the zoom is automatically set at 64.7% (70.7%).

➔ Press [Application] ►► [Booklet].



Settings

[Left Bind]/[Right Bind]	Select the output binding position for copies to be output.
[Center Staple & Fold]	Staples copies at two places along the center, then folds the copies in half before feeding them out.
[Half-Fold]	Feeds out a copied sheet by folding it in two.
[No]	This setting feeds out a copied sheet without Center Staple & Fold or Half-Fold.
[Paper]	Select the paper tray loaded with the desired paper.

Settings

[Cover Sheet]

Copies the front and back cover sheets onto separate paper when copying an original with a front/back cover sheet. When the original to copy does not have a front and back cover, you can insert blank sheets of paper as the front and back covers.



Reference

To specify Auto Display Zoom Ratio:

Press the **Utility/Counter** key ►► [User Settings] ►► [Copier Settings] ►► [Auto Zoom for Combine/Booklet].

5.4.7 [Erase]

[Frame Erase]

Copies can be produced by erasing shadows of punched holes, unnecessary areas around the original text, such as the transmission information on received faxes and the shadows of punched holes. All four sides around the original can be erased in the same width or in a different width for each side.

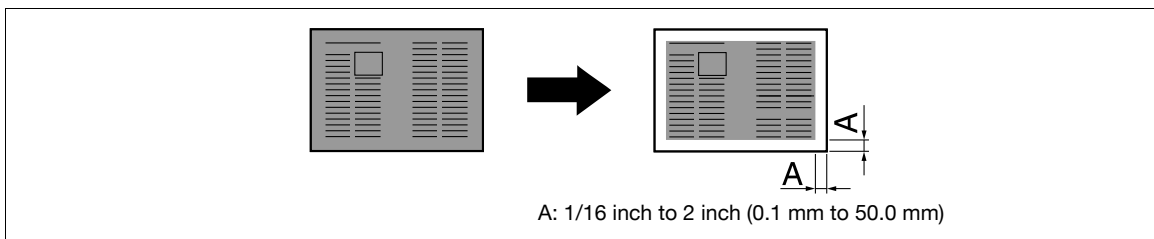

→ Press [Application] ►► [Erase] ►► [Frame Erase].



Settings

[Frame]	Erases the four sides of the original in the same width.
[Top] [Right] [Bottom] [Left]	Erases each frame side in a different width.
[+]/[-]	Press [+] or [-] to set the erasing width between 1/16 inch (0.1 mm) and 2 inches (50.0 mm). The erasing width can also be entered using the keypad.
[None]	Sets the erasing width to 0 inches (0 mm).

[Non-Image Area Erase]

This function enables copying with the **ADF** open while having an original that cannot be loaded in the **ADF** placed at a desired position on the **Original Glass**.

The original is automatically detected and the area outside the original text is erased.

Erase methods include [Bevel] and [Rectangular]. [Bevel] is used when the background of the original is thin and [Rectangular] is used when it is dark.

You can place the original on any position without opening or closing the **ADF** so that you can make copies promptly. In addition, toner consumption will be reduced as the area outside the original text is erased.

[Rectangular]

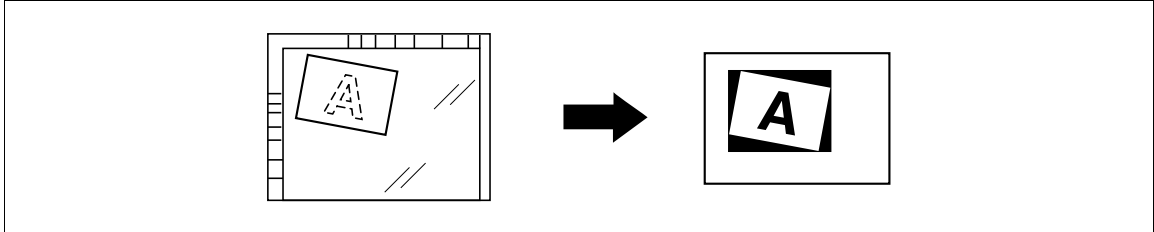

[Bevel]

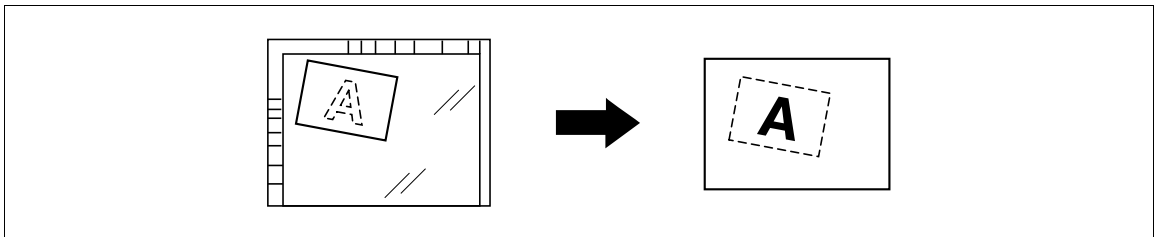

- ✓ If erasing is not performed as desired, set [Erase Operation] under [Erase Adjustment] in Administrator Settings.
 - ✓ The size of the original automatically detected is 3/8 × 3/8 inch (10 × 10 mm) or larger. If the detection fails, a blank sheet of paper is output.
 - ✓ You cannot make copies with the **ADF** closed.
 - ✓ The original image may be detected at its top or end.
- ➔ Press [Application] ►► [Erase] ►► [Non-Image Area Erase].

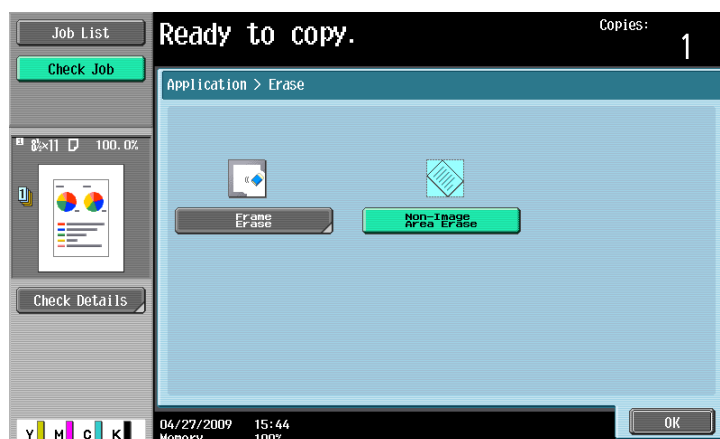

Reference

To set Erase Operation:

Press the **Utility/Counter** key ►► [Administrator Settings] ►► [System Settings] ►► [Expert Adjustment] ►► [Erase Adjustment].

5.4.8 [Stamp/Composition]

Add date and time, page number, stamp, image, or header or footer to make copies.

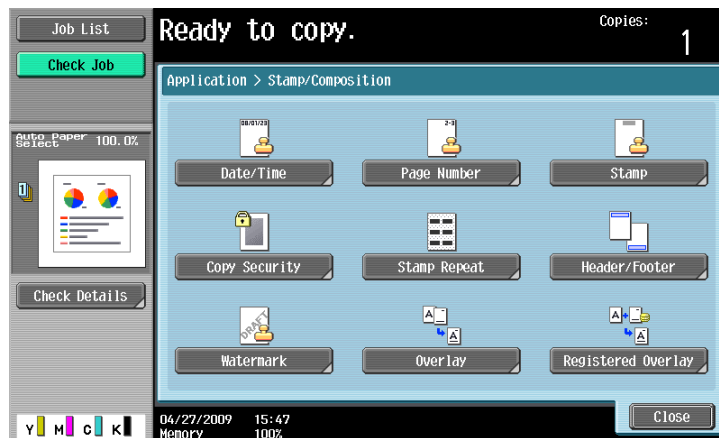

Item

[Date/Time]	Adds date and time to copies.
[Page Number]	Adds page numbers or chapter numbers to copies.
[Stamp]	Adds preset or registered stamps to copies.
[Copy Security]	Adds a hidden text for preventing unauthorized copying in a document when copying. This function also allows you to copy a text with copy inhibit information or password embedded.
[Stamp Repeat]	Repeats copying of a stamp or the date and time onto the paper.
[Header/Footer]	Adds date and time to the top or bottom of the paper to print copies.
[Watermark]	Adds a watermark (watery text) to the center of the copied pages.
[Overlay]	Makes copies with the image of the first scanned original page overlapping the subsequent original images.
[Registered Overlay]	Saves an image of the scanned original as a registered overlay in the hard disk and later overlay the registered image on the copy of another original.

[Date/Time]

You can select the print position and notation format to print the date and time. Specify whether to print on all pages or only on the first page.

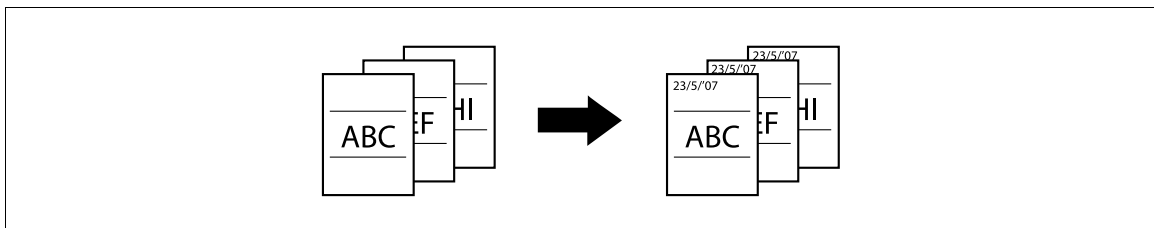

- ✓ The date/time stamp cannot be printed on blank pages inserted using the Cover Sheet, Insert Sheet and Chapters functions. Change the setting for printing on blank pages in Administrator Settings to enable blank page printing.
- ✓ The date/time as of scanning the original is stamped on the paper.

→ Press [Application] ►► [Stamp/Composition] ►► [Date/Time].

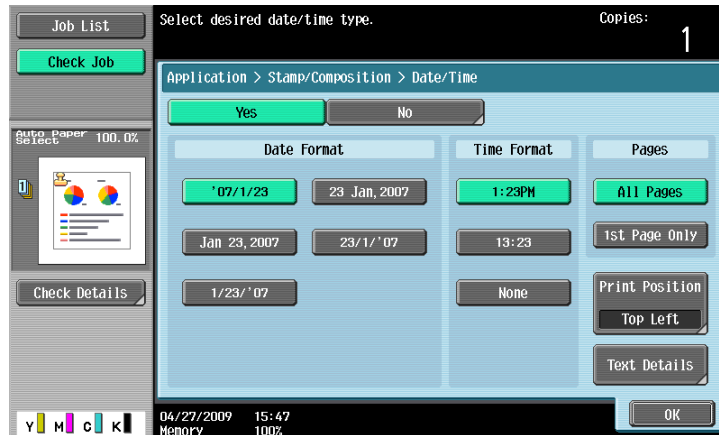

Settings

[Date Format]	Select the type (format) of date and time notation.	
[Time Format]	Select the type (format) of date and time notation. When [None] is selected, the time is not printed.	
[Pages]	Select to print the date/time on all pages or only on the first page.	
[Print Position]	Select a position from the nine print position options.	
	[Adjust Position]	Adjust horizontal and vertical positions to be between 1/16 inch (0.1 mm) and 1-15/16 inch (50.0 mm).
[Text Details]	Set the text color, size and type.	



Reference

To enable printing on blank pages:

Press the **Utility/Counter** key ►► [Administrator Settings] ►► [System Settings] ►► [Blank Page Print Settings].

[Page Number]

You can select the print position and notation format to print page numbers and chapter numbers. Page and chapter numbers are printed on all pages.

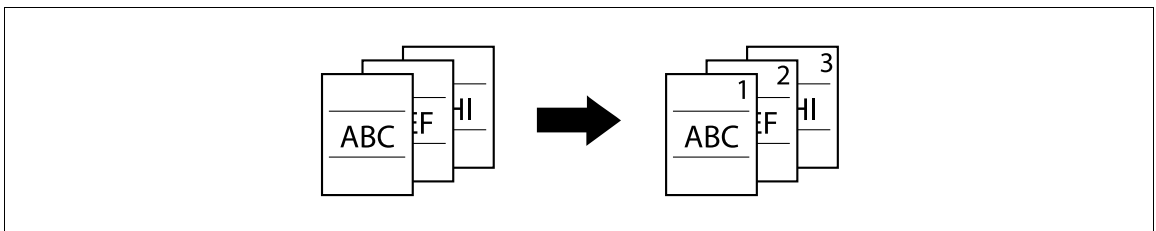

- ✓ Page numbers cannot be printed on blank pages inserted using the Cover Sheet, Insert Sheet and Chapters functions. Change the setting for printing on blank pages in Administrator Settings to enable blank page printing.

→ Press [Application] ►► [Stamp/Composition] ►► [Page Number].

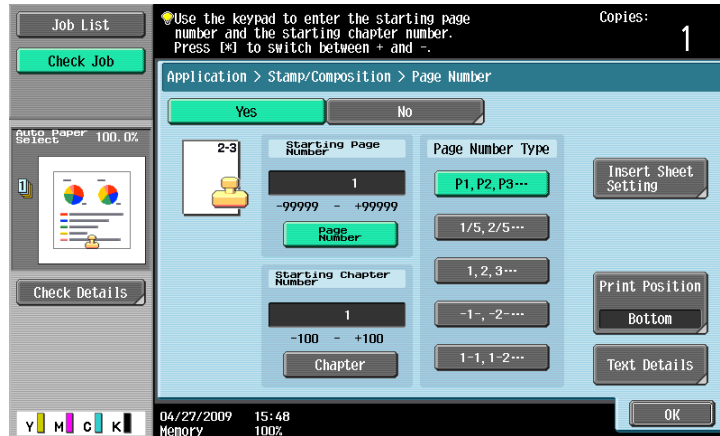

Settings

[Starting Page Number]	<ul style="list-style-type: none"> Set [Page Number] between -99999 and 99999, and set [Chapter] between -100 and 100. Press [*] to switch over the signs (+ and -) of the setting. If a negative value is specified, the numbers are not printed until the numbering reaches 1. For example, if "-1" was specified, the numbers are printed starting with "1" on the third copied page. The entered chapter number is printed if [1-1, 1-2...] is selected under [Page Number Type]. 						
[Starting Chapter Number]							
[Page Number Type]	Select the type (format) of the page.						
[Insert Sheet Setting]	Set this parameter when using the Cover Sheet, Insert Sheet and Chapters functions together.						
	<table border="1"> <tr> <td>[Cover Sheet]</td> <td> [Print on Front and Back Cover]: Prints on the front and back covers. [Print on Back Cover only]: Prints a page number on the back cover but not on the front cover. Page number printing starts with "2" for 1-sided copy and with "3" for 2-sided copy. [Do not print Page Number]: Disables printing on the front or back cover. Page number printing starts with "2" for 1-sided copy and with "3" for 2-sided copy. </td> </tr> <tr> <td>[Insert Sheet (Copy)]</td> <td> [Print Page #]: Prints on inserted pages. [Do Not Print #]: Counts but not prints on inserted pages. [Skip the Page(s)]: Disables counting and printing on inserted pages. </td> </tr> <tr> <td>[Insert (Blank)]</td> <td> [Do Not Print #]: Counts but not prints on inserted pages. [Skip the Page(s)]: Disables counting and printing on inserted pages. </td> </tr> </table>	[Cover Sheet]	[Print on Front and Back Cover]: Prints on the front and back covers. [Print on Back Cover only]: Prints a page number on the back cover but not on the front cover. Page number printing starts with "2" for 1-sided copy and with "3" for 2-sided copy. [Do not print Page Number]: Disables printing on the front or back cover. Page number printing starts with "2" for 1-sided copy and with "3" for 2-sided copy.	[Insert Sheet (Copy)]	[Print Page #]: Prints on inserted pages. [Do Not Print #]: Counts but not prints on inserted pages. [Skip the Page(s)]: Disables counting and printing on inserted pages.	[Insert (Blank)]	[Do Not Print #]: Counts but not prints on inserted pages. [Skip the Page(s)]: Disables counting and printing on inserted pages.
[Cover Sheet]	[Print on Front and Back Cover]: Prints on the front and back covers. [Print on Back Cover only]: Prints a page number on the back cover but not on the front cover. Page number printing starts with "2" for 1-sided copy and with "3" for 2-sided copy. [Do not print Page Number]: Disables printing on the front or back cover. Page number printing starts with "2" for 1-sided copy and with "3" for 2-sided copy.						
[Insert Sheet (Copy)]	[Print Page #]: Prints on inserted pages. [Do Not Print #]: Counts but not prints on inserted pages. [Skip the Page(s)]: Disables counting and printing on inserted pages.						
[Insert (Blank)]	[Do Not Print #]: Counts but not prints on inserted pages. [Skip the Page(s)]: Disables counting and printing on inserted pages.						
[Print Position]	Select a position from the nine print position options.						
	<table border="1"> <tr> <td>[Adjust Position]</td> <td>Adjust horizontal and vertical positions to be between 1/16 inch (0.1 mm) and 1-15/16 inch (50.0 mm).</td> </tr> </table>	[Adjust Position]	Adjust horizontal and vertical positions to be between 1/16 inch (0.1 mm) and 1-15/16 inch (50.0 mm).				
[Adjust Position]	Adjust horizontal and vertical positions to be between 1/16 inch (0.1 mm) and 1-15/16 inch (50.0 mm).						
[Text Details]	Set the text color, size and type.						



Reference

To configure the settings for the Cover Sheet, Insert Sheet and Chapters functions:

Press [Application] ►► [Sheet/Cover/Chapter Insert].

To configure the settings for the Chapters function:

Press [Application] ►► [Sheet/Cover/Chapter Insert] ►► [Chapters].

To enable printing on blank pages:

Press the **Utility/Counter** key ►► [Administrator Settings] ►► [System Settings] ►► [Blank Page Print Settings].

[Stamp]

You can select the print position and notation format to print the stamp. Select printing on all pages or only on the first page.

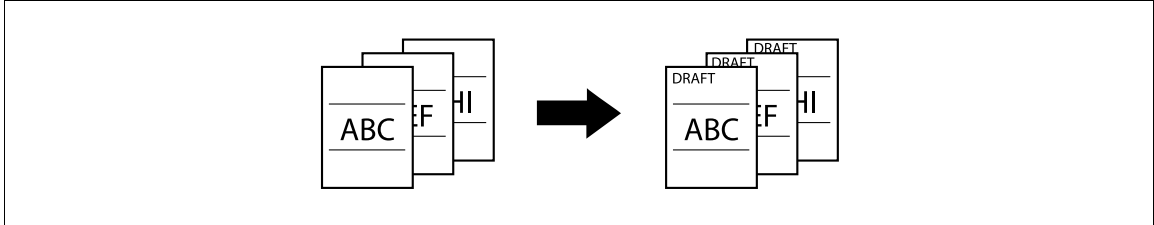

- ✓ A stamp refers to text with printing contents fixed and preset. You can also select a stamp registered with **Web Connection** or **Copy Protection Utility**.
- ✓ Stamps cannot be printed on blank pages inserted using the Cover Sheet, Insert Sheet and Chapters functions. Change the setting for printing on blank pages in Administrator Settings to enable blank page printing.

➔ Press [Application] ►► [Stamp/Composition] ►► [Stamp].

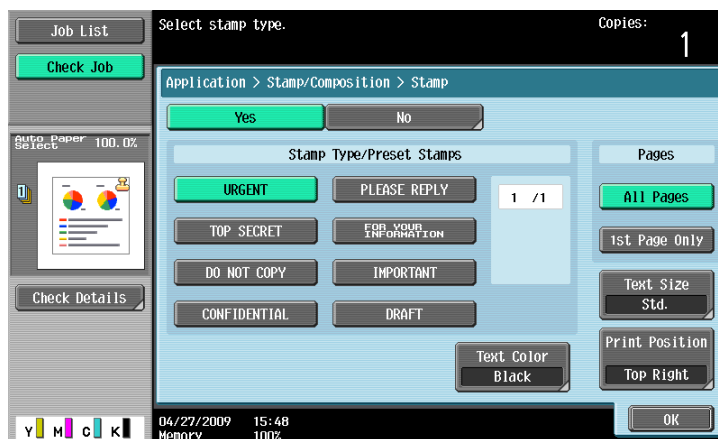

Settings

[Stamp Type/Preset Stamps]	Select a stamp to be printed from the eight types available.
[Pages]	Select to print the stamp on all pages or only on the first page.
[Text Size]	Select the character size used for the stamp.
[Text Color]	Select the text color for the stamp.
[Print Position]	Select a position from the nine print position options.
	[Adjust Position] Adjust horizontal and vertical positions to be between 1/16 inch (0.1 mm) and 1-15/16 inch (50.0 mm).



Reference

To enable printing on blank pages:

Press the **Utility/Counter** key ►► [Administrator Settings] ►► [System Settings] ►► [Blank Page Print Settings].

[Copy Protect]

This function allows you to print a hidden text for preventing unauthorized copying, for example, a preset stamp such as Private or date, in the background without particular distinction. If you copy a document with Copy Protect printed, a text is highlighted on the entire sheet of paper to be printed, enabling you to know that the copy is not authorized.

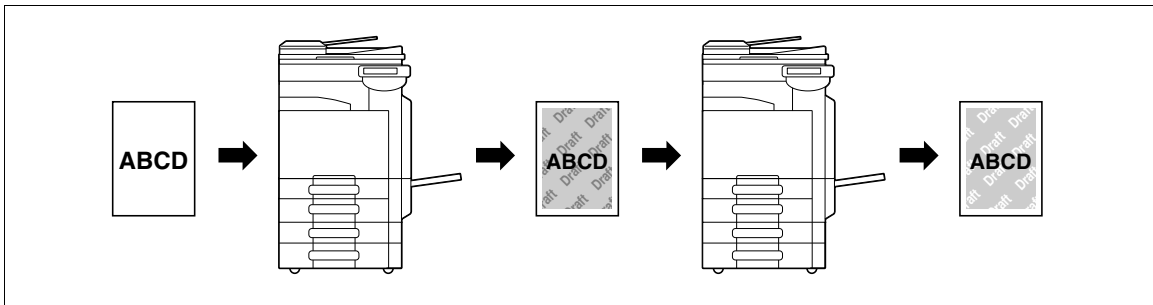

- ✓ The copy protection text is printed on all pages. The page to start with cannot be specified.
 - ✓ The selected copy protection text formats appear in the order they are placed, and can be used in combination for up to eight text lines.
 - ✓ Use **Web Connection** or **Copy Protection Utility** to register a registered stamp.
 - ✓ Multiple registered stamps or preset stamps cannot be selected.
- ➔ Press [Application] ►► [Stamp/Composition] ►► [Copy Security] ►► [Copy Protect].

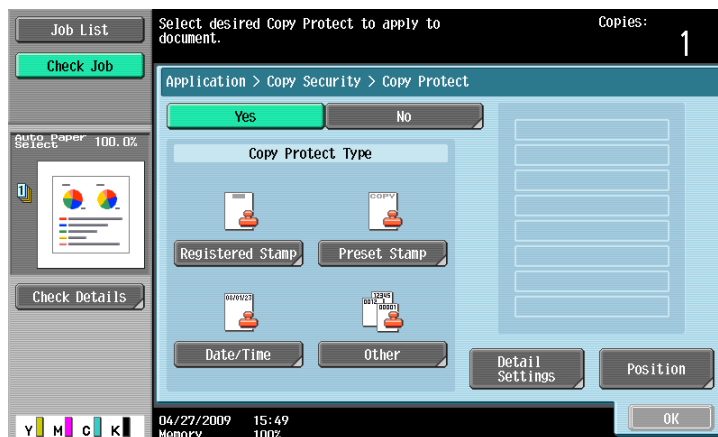

Settings

[Registered Stamp]	Select one from registered stamps.	
[Preset Stamp]	Select a stamp to be printed from the eight types available.	
[Date/Time]	Select the type of date and time notation. When [None] is selected for Time Format, the time is not printed. The date/time as of scanning the original is stamped on the paper.	
[Other]	[Job Number]	Select Yes to print the copy job number.
	[Serial Number]	Select Yes to print the serial number of this machine. For details on setting for the serial number, contact your service representative.
	[Distribution Control Number]	Prints the distribution control number. Specify the distribution control number using a value between 1 and 99999999.
[Detail Settings]	Configure the settings for [Text/Background Color], [Density], [Copy Protect Pattern], [Text Size], [Pattern Overwrite], and [Background Pattern].	

Settings

[Position]	The angle can be changed when there are no more than four lines in the selected copy protection text.
[Change Pos./Delete]	<p>Change the arrangement order. Select the target copy protection text and press [Up] or [Down].</p> <p>To add a space to the copy protection text, press [Insert Space]. Press either [Up] or [Down] to move  that appears beside the specified copy protection text type, and then press [Insert].</p> <p>To delete the copy protection text, press [Delete], and then press the button for the copy protection text to be deleted.</p>



Reference

To delete a registered stamp:

Press the **Utility/Counter** key ►► [Administrator Settings] ►► [Security Settings] ►► [Stamp Settings] ►► [Delete Registered Stamp].

[Copy Guard]

This function prints a document, embedding a Copy Guard pattern in a copy protect text, for example, a pre-set stamp such as Private or date.

If an attempt is made to copy copy-guarded sheets, the machine that supports this function scans a Copy Guard pattern, stops copying, and discards the currently running job.

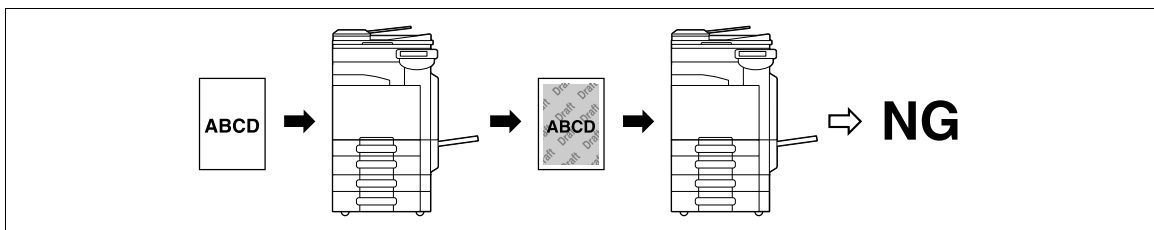

- ✓ For a text, specify the desired one from [Preset Stamp] that is registered in advance.
 - ✓ A copy guard is printed on all pages. The page to start with cannot be specified.
 - ✓ The selected copy guards appear in the order they are placed, and can be used in combination for up to six text lines.
 - ✓ [Preset Stamp], [Date/Time], and [Other] can be selected together.
 - ✓ In [Preset Stamp], multiple copy guards cannot be selected.
 - ✓ A copy guard cannot be printed on a colored paper, envelope, or transparency film.
- ➔ Press [Application] ►► [Stamp/Composition] ►► [Copy Security] ►► [Copy Guard].



Settings

[Copy Guard Type]	[Preset Stamp]	Select a stamp to be printed from the eight types available.
	[Date/Time]	Specify the type of the date or time to be printed on paper. The date/time as of scanning the original is stamped on the paper.
	[Other]	Specify [Job Number], [Serial Number], and [Distribution Control Number] to be printed on paper. [Serial Number] is assigned at the time of shipment of this machine. For details on settings, contact your service representative.
[Detail Settings]	Specify [Text/Background Color], [Copy Guard Pattern], [Text Size], and [Background Pattern] to be printed on paper.	



Reference

To specify and detect a copy guard:

Press the **Utility/Counter** key ►► [Administrator Settings] ►► [Security Settings] ►► [Security Details] ►► [Copy Guard].

[Password Copy]

This function prints a document, embedding a copy protect text, for example, a preset stamp such as Private or date, and a password for Password Copy.

If an attempt is made to copy password-copied sheets, the machine that supports this function scans a Password Copy pattern and prompts you to enter the password. When the correct password is entered, copying will start.

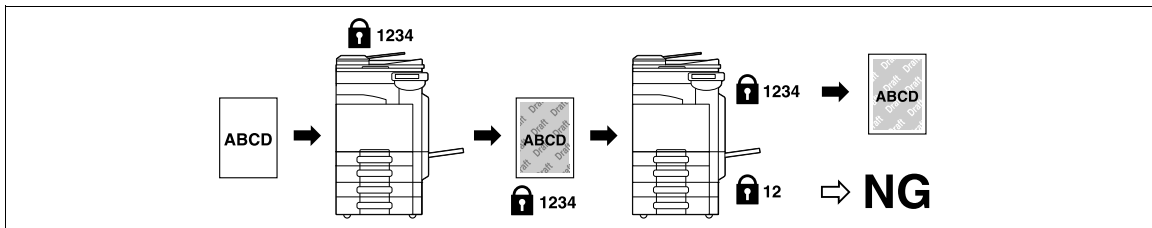

- ✓ For a text, specify the desired one from [Preset Stamp] that is registered in advance.
- ✓ A password copy is printed on all pages. The page to start with cannot be specified.
- ✓ The selected password copies appear in the order they are placed, and can be used in combination for up to six text lines.
- ✓ [Preset Stamp], [Date/Time], and [Other] can be selected together.
- ✓ In [Preset Stamp], multiple passwords cannot be selected.
- ✓ A password copy cannot be printed on a colored paper, envelope, or transparency film.
- ✓ If you fail to enter a password three times, the currently processed copy job will be erased.
- ✓ If a password is detected on copies with Zoom, 2 Color, Grayscale, Color Adjust, Colored Paper, Envelope, or Transparency specified, the currently processed copy job will be erased.
- ✓ If multiple originals with different passwords are scanned, you will need to enter a password for each original.

→ Press [Application] ►► [Stamp/Composition] ►► [Copy Security] ►► [Password Copy].

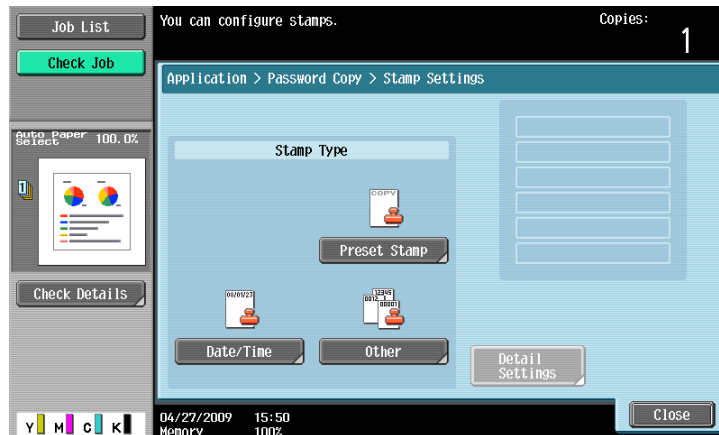

Settings

[Stamp Type]	[Preset Stamp]	Select a stamp to be printed from the eight types available.
	[Date/Time]	Specify the type of the date or time to be printed on paper. The date/time as of scanning the original is stamped on the paper.
	[Other]	Specify [Job Number], [Serial Number], and [Distribution Control Number] to be printed on paper. [Serial Number] is assigned at the time of shipment of this machine. For details on settings, contact your service representative.
[Detail Settings]	Specify [Text/Background Color], [Password Copy Pattern], [Text Size], and [Background Pattern] to be printed on paper.	



Reference

To specify and detect a password copy:

Press the **Utility/Counter** key ►► [Administrator Settings] ►► [Security Settings] ►► [Security Details] ►► [Password Copy].

[Stamp Repeat]

You can print a stamp, the date and time, or other specified items on all pages of the copy.

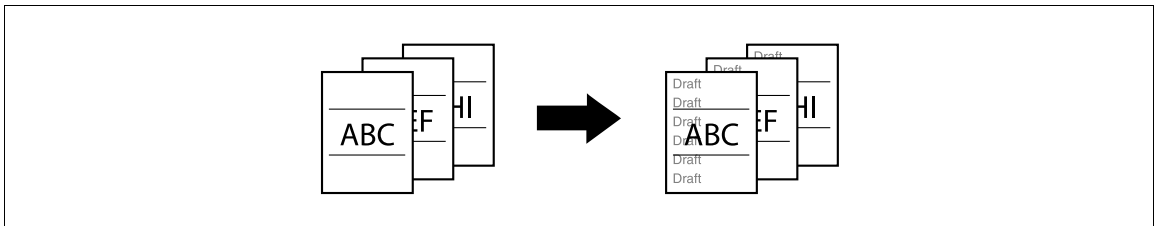

- ✓ The printing contents of the Stamp Repeat function are printed on all pages.
- ✓ The selected stamps appear in the order they are placed, and can be used in combination for up to eight text lines.
- ✓ Use **Web Connection** or **Copy Protection Utility** to register a registered stamp.
- ✓ Multiple registered stamps or preset stamps cannot be selected.

→ Press [Application] ►► [Stamp/Composition] ►► [Stamp Repeat].

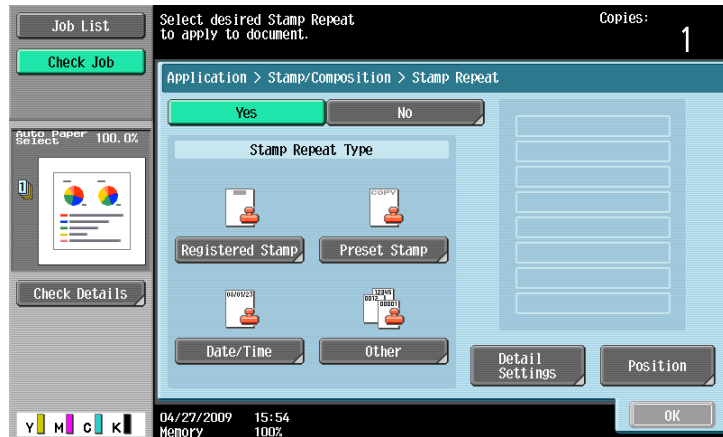

Settings

[Registered Stamp]	Select one from registered stamps.	
[Preset Stamp]	Select a stamp to be printed from the eight types available.	
[Date/Time]	Select the type of date and time notation. When [None] is selected for Time Format, the time is not printed. The date/time as of scanning the original is stamped on the paper.	
[Other]	[Job Number]	Select Yes to print the copy job number.
	[Serial Number]	Select Yes to print the serial number of this machine. For details on setting for the serial number, contact your service representative.
	[Distribution Control Number]	Prints the distribution control number. Specify the distribution control number using a value between 1 and 99999999.
[Detail Settings]	Select the [Text Color], [Density], [Text Size] and [Pattern Overwrite].	
[Position]	Change the angle as required when there are no more than four lines in the selected repeating stamp.	
	[Change Pos./Delete]	Change the arrangement order. Select the target Stamp Repeat and press [Up] or [Down]. To add a space to repeated stamps, press [Insert Space]. Press either [Up] or [Down] to move ○ that appears beside the specified Stamp Repeat, and then press [Insert]. To delete the Stamp Repeat text, press [Delete], and then press the button for the Stamp Repeat text to be deleted.



Reference

To delete a registered stamp:

Press the **Utility/Counter** key ►► [Administrator Settings] ►► [Security Settings] ►► [Stamp Settings] ►► [Delete Registered Stamp].

[Header/Footer]

This setting enables printing the date/time and text at the top or the bottom of the paper. The date/time or a distribution number can be printed on each page. The header and footer can contain predetermined contents, but you can also temporarily change the contents.

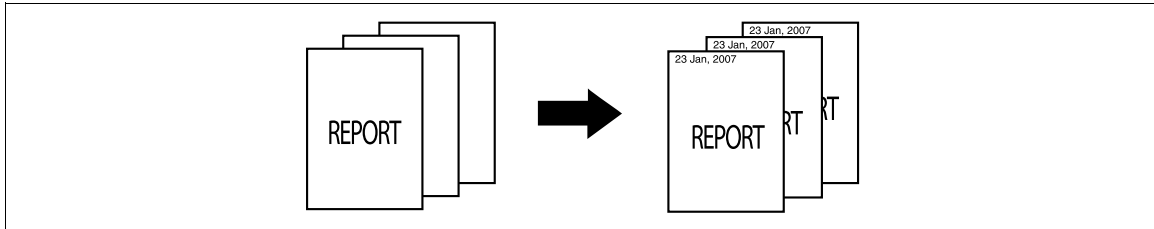

- ✓ In order to use the Header/Footer function, a header/footer must be registered in Administrator Settings. If no header/footer is registered in Administrator Settings, the [Header/Footer] menu does not appear.

→ Press [Application] ►► [Stamp/Composition] ►► [Header/Footer].

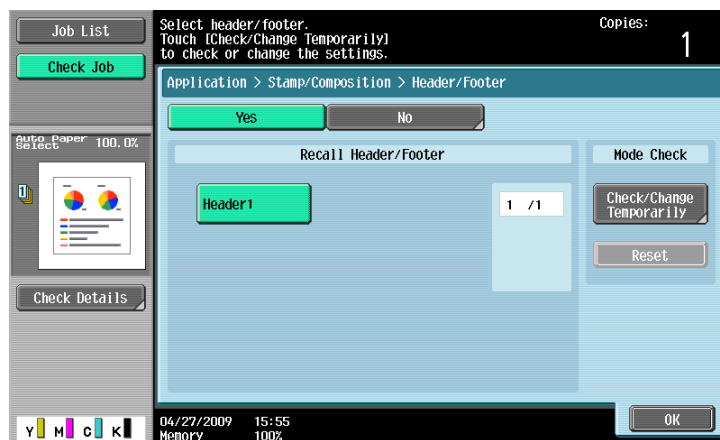

Settings

[Recall Header/Footer]	Select a header/footer to be used.	
[Check/Change Temporarily]	Check or temporarily change the contents of the registered header/footer.	
	[Header Settings]	Select to enable or disable printing of a header/footer. To print a header/footer, configure the following settings: [Text]: Enter the text for the header/footer. [Date/Time]: Select the type of date and time notation. [Other]: Select to print or not to print the distribution control number, job number, or serial number.
	[Footer Settings]	
	[Pages]	Select to print the header/footer on all pages or only on the first page.
	[Text Details]	Select the [Text Color], [Text Size] and [Text Type].
[Reset]	Reset the settings to the initial contents.	



Reference

To register a header/footer:

Press the **Utility/Counter** key ►► [Administrator Settings] ►► [System Settings] ►► [Stamp Settings] ►► [Header/Footer Settings].

[Watermark]

You can print a watermark (light text) at the center of the paper. Select fixed preset text to be printed such as [Invalid Copy] and [Private].

Copying with a watermark enables explicit indication of the use of the copied paper. It also helps prevent unauthorized copy from the copied paper.

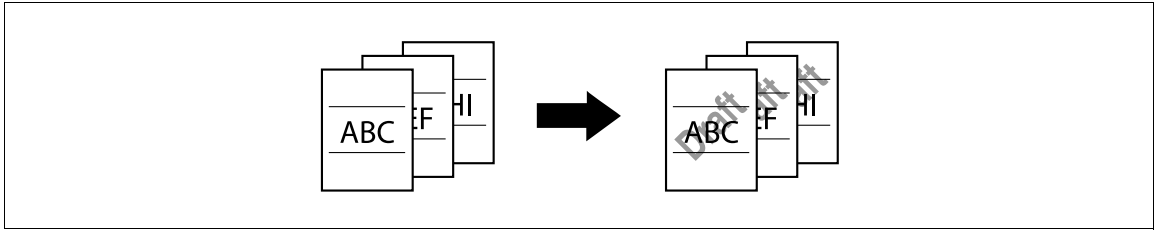

- ✓ The watermark is printed on all pages at an angle of 45 degrees. It is printed once per page.
 - ✓ In case other settings affect the watermark printing to cause partial loss, the Watermark function is canceled upon copying.
- Press [Application] ►► [Stamp/Composition] ►► [Watermark].

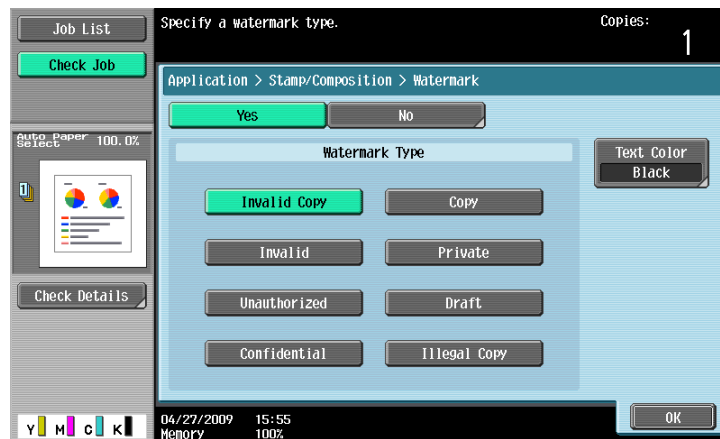

Settings

[Watermark Type]	Select a watermark from the eight types available. The watermark selected is printed over the original image.
[Text Color]	Select the watermark color from [Black], [Magenta] and [Cyan]. The watermark is printed in the selected color.

[Overlay]

Makes copies with the image of the first scanned original page overlapping the subsequent original images. For example, if you set Overlay to copy three original pages, two pages are output, including "a merged image of the first and second pages" and "a merged images of the first and the third pages".

The Overlay function is useful for overlay of text, pictures or figures not prepared in other Stamp/Composition functions on the original.

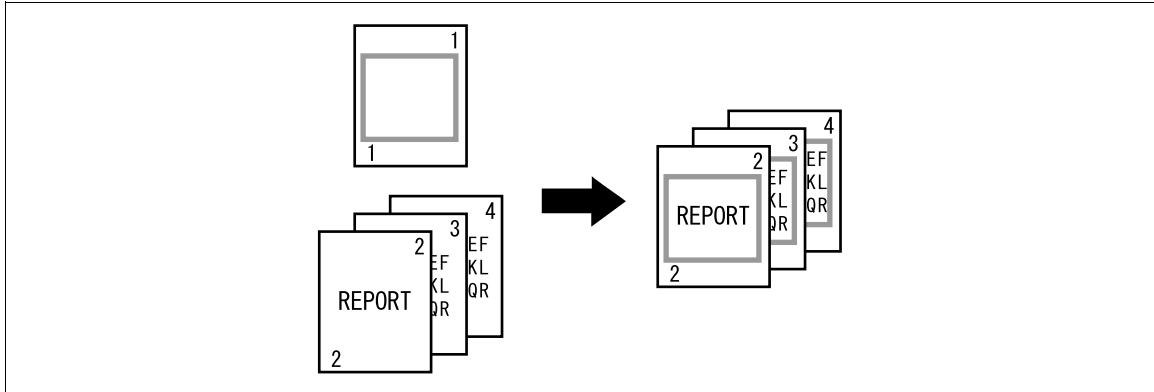

→ Press [Application] ►► [Stamp/Composition] ►► [Overlay].

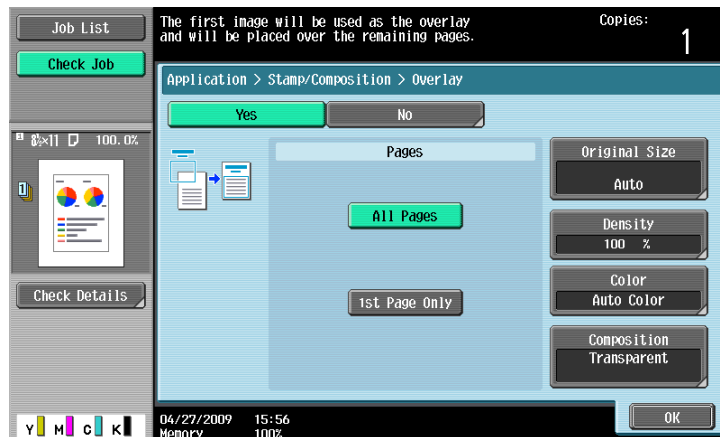

Settings

[Pages]	Select to print the overlay image on all pages or only on the first page. Selecting [1st Page Only] prints only on the second page of the original.	
[Original Size]	Select [Auto] to detect the size of the original automatically. If the size of the original is not automatically detected, select the original size.	
	[Custom Size]	Enter the original size.
	[Photo Size]	Select the photo size.
[Density]	Use the keypad to enter the density of an overlay image. (using a value between 20 to 100%)	
[Color]	Select the color of overlay image from [Full Color], [Black], [Red], [Blue], [Green], [Yellow], [Cyan], or [Magenta].	

Settings

[Composition]	[Transparent]	Composes overlay image to be superimposed and increases the brightness of the image. This setting prevents an original from being hidden by the composed overlay image.
	[Background Composition (Original)]	Composes the original as the background. The overlay image is superimposed on the original when they are printed.
	[Back]	Composes the overlay image as the background. The original is superimposed on the overlay image when they are printed.

[Registered Overlay]

This function enables storing of an image from the scanned original as a registered overlay on the hard disk for later use in copying another original. It is useful to register frequently used overlay images.

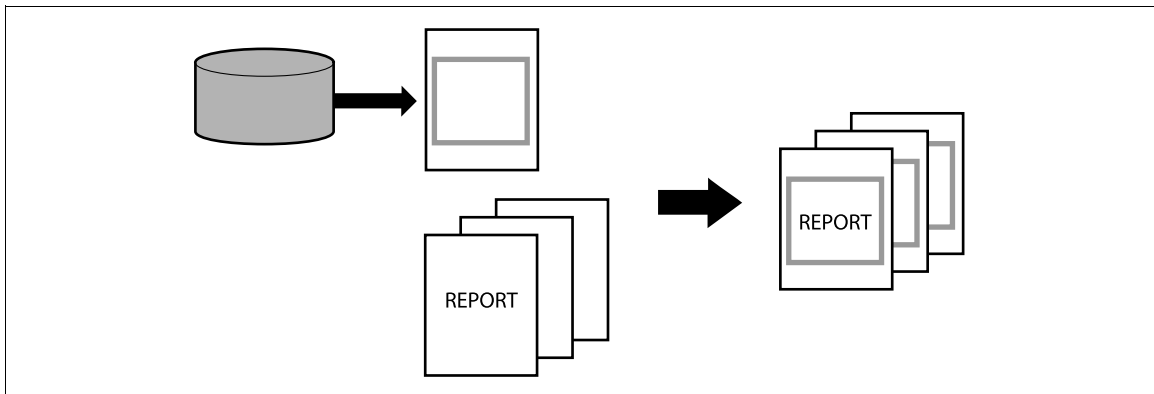

→ Press [Application] ►► [Stamp/Composition] ►► [Registered Overlay].

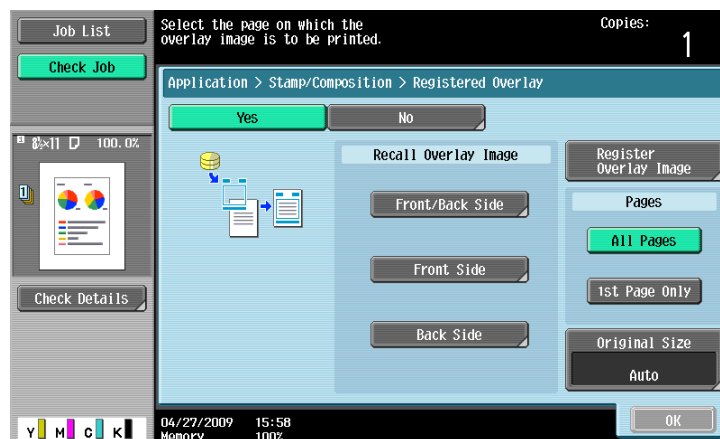

Settings

[Recall Overlay Image]	Specify whether to print a registered overlay image on the front or back side. Press an item to select an overlay image and configures its setting. <ul style="list-style-type: none"> You cannot select an overlay image when no overlay has been registered. 	
	[Thumbnail View]/[Display Name]	In the thumb-nail view, you can check overlay images. In the Display Name mode, you can check overlay images using their file names. Select the desired overlay image.
	[Detail Settings]	[Density]: Use the keypad to enter the density of an overlay image. (using a value between 20 to 100%) [Color]: Select the color of overlay image from [Full Color], [Black], [Red], [Blue], [Green], [Yellow], [Cyan], or [Magenta]. [Composition]: [Transparent] Composes overlay image to be superimposed and increases the brightness of the image. This setting prevents an original from being hidden by the composed overlay image. [Background Composition (Original)] Composes the original as the background. The overlay image is superimposed on the original when they are printed. [Back] Composes the overlay image as the background. The original is superimposed on the overlay image when they are printed.
	[Image Details]	Check the [Name], [Registered Date], [Image Size], and [Color] of the overlay image. To confirm the enlarged overlay image, press [Preview].
[Register Overlay Image]	[New]	Enter the name of the overlay image to be registered. Load the overlay image original on the original glass and press the Start key to have the overlay image registered.
	[Overwrite]	Select an overlay image to use for overwrite and press [Overwrite]. Load the overlay image original on the original glass and press the Start key to have the overlay image overwritten.
	[Delete]	Select an overlay image to be deleted and press [Delete].
	[Detail Settings]	[Density]: Specify the density of an overlay to be registered between 20% and 100%. [Color]: Select the color for the overlay image to be registered from [Auto Color], [Full Color] and [Black].
[Pages]	Select to print the overlay image on all pages or only on the first page.	
[Original Size]	Select [Auto] to detect the size of the original automatically. If the size of the original is not automatically detected, select the original size.	
	[Custom Size]	Enter the original size.
	[Photo Size]	Select the photo size.

**Reference**

To prohibit changing the overlay registration:

Press the **Utility/Counter** key ►► [Administrator Settings] ►► [System Settings] ►► [Restrict User Access] ►► [Restrict Access to Job Settings] ►► [Change Registered Overlay].

5.4.9 [Card Shot]

Separately scans the contents of the front and back sides of a card, for example, insurance card, driver's license, or business card, and copies them together on one sheet.

You can copy a card with the full size or enlarge an image to fit paper.

Using the card copy function, you can save the number of sheets to be used.

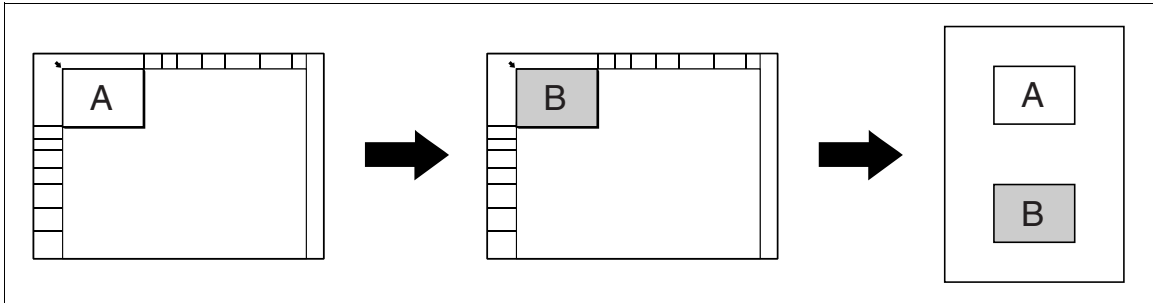

- ✓ A card must be placed in the erect mode on the original glass.
- ✓ The card copy function and the auto paper function cannot be selected at the same time.
- ✓ For some zoom values, part of the image may be cut off.

→ Press [Application] ►► [Card Shot].

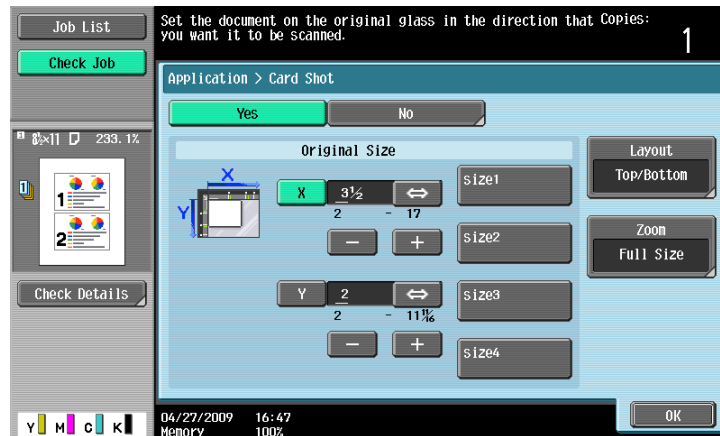

Settings

[Original Size]	Press [X] and [Y], and enter the size of the card to be copied. Also select the pre-specified size from [size1] to [size4].
[Layout]	Specify where to place the front and back sides of a card.
[Zoom]	You can copy a card with the full size or enlarge an image to fit paper.



Reference

To specify the default of Card Copy:

Press the **Utility/Counter** key ►► [Administrator Settings] ►► [Copier Settings] ►► [Card Shot Settings].

5.4.10 [Save in User Box]

This function enables saving of data from the scanned originals on the hard disk (in the User Box) built in the machine. Documents saved in User Boxes can be printed when necessary.

For details on using documents saved in User Boxes, refer to the [User's Guide Box Operations].

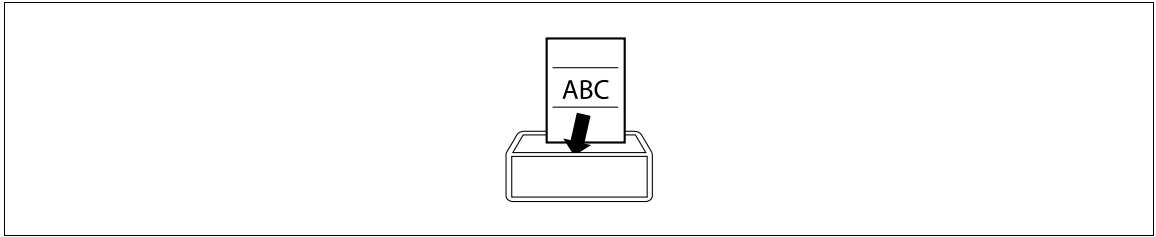

→ Press [Application] ►► [Save in User Box].

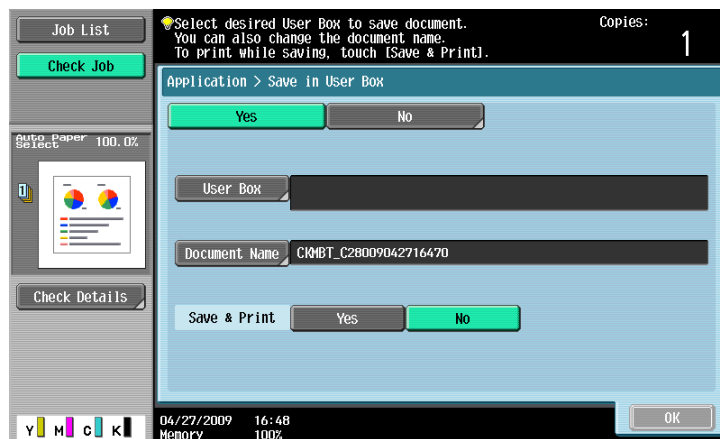

Settings

[User Box]	Select the destination User Box.
[Document Name]	Specify a document name for the read original. A name automatically assigned to the document appears. You can change the file name.
[Save & Print]	[Yes]: Select to copy the scanned original and save it in the specified User Box. [No]: Select to save the data of the scanned original in the specified User Box.

5.5 Left panel display

In the left panel of the basic settings screen, you can view the job list and the job status information.

You can also view the result of the settings being configured.

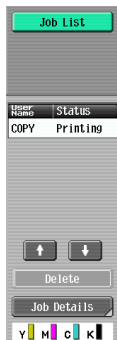

Job List

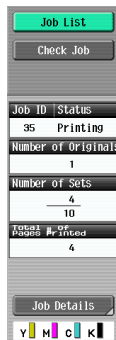

Check Job

Settings

[Job List]	Lists jobs currently being performed or waiting to be performed. If the Left Panel Display Default is set to [Status Display] in User Settings, the job status is displayed.	
	[Delete]	To delete a job, select the job from the job list, and then press [Delete].
	[Job Details]	Opens the Job List screen.
[Check Job]	Displays the result of the settings being configured.	
	[Check Details]	Check or change the current copy settings.



Reference

To configure settings displayed as the default in the left panel:

Press the **Utility/Counter** key ►► [User Settings] ►► [Custom Display Settings] ►► [Left Panel Display Default].

To prohibit other users from deleting jobs or to give permission to do so:

Press the **Utility/Counter** key ►► [Administrator Settings] ►► [System Settings] ►► [Restrict User Access] ►► [Restrict Access to Job Settings] ►► [Delete Other User Jobs].

To prohibit or permit change if the print priority of jobs:

Press the **Utility/Counter** key ►► [Administrator Settings] ►► [System Settings] ►► [Restrict User Access] ►► [Restrict Access to Job Settings] ►► [Changing Job Priority].

To hide the file name and destination in the job log:

Press the **Utility/Counter** key ►► [Administrator Settings] ►► [Security Settings] ►► [Security Details] ►► [Hide Personal Information].

To delete all job logs:

Press the **Utility/Counter** key ►► [Administrator Settings] ►► [Security Settings] ►► [Security Details] ►► [Initialize] ►► [Job History].

5.5.1 [Job List]

From the Job List screen, lists of jobs being performed by this machine and the jobs that have been performed in addition to the job details can be viewed, and the job settings can be changed.

- ✓ If user authentication settings have been applied and the machine is set so that jobs cannot be deleted by other users, the job is not deleted.
- ✓ If an Administrator Settings parameter was set so that the output priority of jobs cannot be changed, [Increase Priority] does not appear and the output priority of the jobs cannot be specified.
- ✓ When there is a job being printed, another job can be registered. Up to 251 jobs can be registered in total.
- ✓ If the authentication method is changed in Administrator Settings and all management data is cleared, the jobs in the [Job History] are deleted.

→ Press [Job List] ►► [Job Details] ►► [Print].

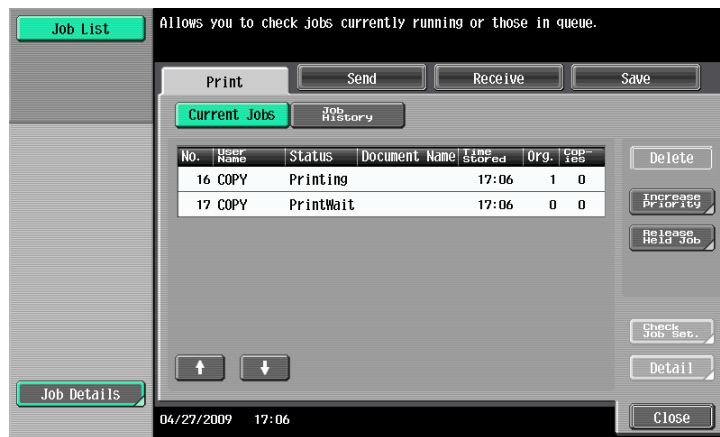

Settings

[Print]	Opens the screen for checking print jobs.
[Send]	Opens the screen for checking fax and scan transmission jobs. For details, refer to the [User's Guide Network Scan/Fax/Network Fax Operations].
[Receive]	Opens the screen for checking fax reception jobs. For details, refer to the [User's Guide Network Scan/Fax/Network Fax Operations].
[Save]	Opens the screen for saving jobs. For details, refer to the [User's Guide Box Operations].

Settings

[Current Jobs]	Lists the jobs currently processed. Check the current status.	
	[Delete]	Deletes a job.
	[Increase Priority] (Displayed for the list of print jobs in process)	The currently processed print job is interrupted and printing of the job given priority begins. Printing of the interrupted job is automatically restarted once printing for the job given priority is finished. If the currently processed print job cannot be interrupted because it contains Fold or Staple, the job given priority is executed after the currently processed print job has been completed.
	[Release Held Job] (Displayed for the list of print jobs in process)	Select to switch to the held job list and change the settings of, print, or delete a held job. The held job list contains jobs that could not be printed because, for example, system auto reset was activated during the proof copy. <ul style="list-style-type: none"> • If desired, press [Change Setting] to change the copy settings. • For confirmation, press the [Preview] key to print a copy from a stored job.
	[Check Job Set.]	Check job settings for stored jobs, jobs being printed, jobs queued to be printed, and held jobs.
	[Detail]	Check the status, results, error details, user name, queued time, completed time, number of original pages and number of copies for jobs in process. To delete the job, press [Delete] in the Detail screen.
[Job History]	Lists completed jobs. <ul style="list-style-type: none"> • This list includes jobs that failed because of an error. • You can check the job logs and results. • [Scanned Image] in the left panel displays the first page of the selected job with a thumbnail. To display thumbnails in [Scanned Image], set [Job History Thumbnail Display] in [Administrator Settings] to [ON]. For details, refer to page 7-48. 	
	[Deleted Jobs]	Displays only jobs that were deleted before they were finished.
	[Finished Jobs]	Displays only jobs that were completed normally.
	[All Jobs]	Displays all jobs.
	[Detail]	Check the status, results, error details, user name, queued time, completed time, number of original pages and number of copies for jobs in the Job History list.

5.5.2 [Check Job]

From the Check Job Settings screens, the current copy settings can be checked and changed if desired.

- 1 Press [Check Job] ►► [Check Details].

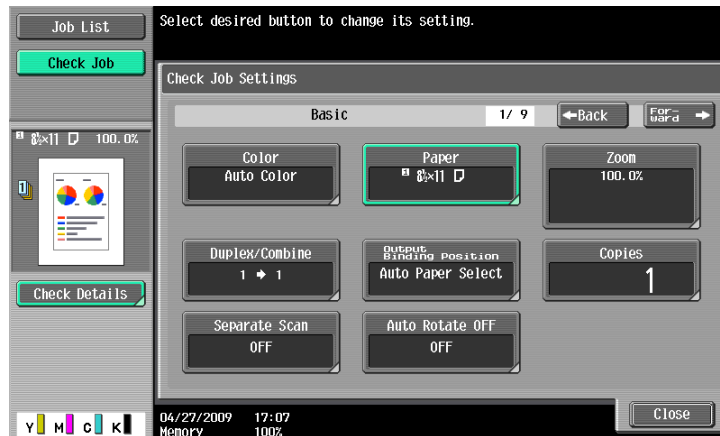

- 2 Check the copy settings. To change the copy settings, press the relevant button.
- 3 After checking the settings, press [Close].

6

[User Settings]

6 [User Settings]

[User Settings] are for setting items that a user can adjust as appropriate.

The contents of these setting items depend upon how the [Administrator Settings] are configured. [User Settings] cannot be initialized all at once. To initialize all settings, either manually reset them one by one or contact your service representative.



Settings

[System Settings]	Configure the basic functions of this machine.
[Custom Display Settings]	Change the touch panel display to the convenience of the user.
[Copier Settings]	Configure the settings for copy functions to be used in copy operations.
[Scan/Fax Settings]	Configure setting for fax and scan operations.
[Printer Settings]	Configure setting is for the printer operations.
[Change Password]	Change the password for the user who is currently logged in.
[Change E-Mail Address]	Change the E-mail addresses specified for registered users.
[Change Icon]	Change the icons specified for registered users.
[Register Authentication Information]	Register or delete the biometric authentication information or IC card authentication information of the current login user.
[Cellular Phone/PDA Setting]	Configure settings to print data from a cellular phone or PDA.

6.1 [System Settings]

Configure the basic functions of this machine.

→ Press the **Utility/Counter** key ►►[User Settings] ►► [System Settings].

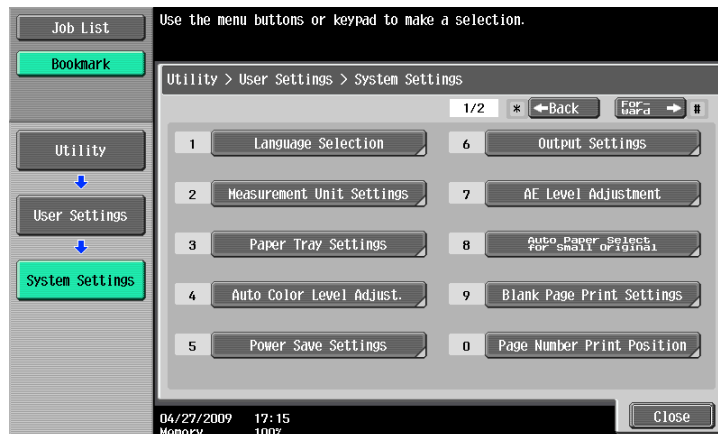

Settings

[Language Selection]	Select the language for display in the touch panel.	
[Measurement Unit Settings]	Select the units for the values displayed in the touch panel.	
[Paper Tray Settings]	[Auto Tray Selection Settings]	Select the trays to be selected automatically when the Auto Paper Select function is enabled. Also configure the priority for the auto tray switch operation to switch paper trays when it is enabled. <ul style="list-style-type: none"> Configure [Auto Paper Selection Setting] to use paper types other than plain paper as plain paper in a regular auto paper selection mode.
	[Auto Tray Switch ON/OFF]	Select whether a paper tray loaded with paper of the same size is selected automatically when a paper tray that was selected manually becomes empty while printing copies.
	[No Matching Paper in Tray Setting]	Specify the action to be taken when the matching paper is not loaded into the specified paper tray. <ul style="list-style-type: none"> [Stop Printing (Tray Fixed)] Printing stops. [Switch Trays (Tray Priority)] Whether the matching paper is loaded into the specified paper tray is determined first. And if not, another tray that has the matching paper loaded (if any) is selected.
	[Print Lists]	Select the paper tray used for printing lists, such as the sales counter and consumables indicators. Also select whether to print lists in 1-Sided or 2-Sided mode.
[Auto Color Level Adjust.]	Adjust the reference level for detecting a color or black-and-white original when the Auto Color setting is selected.	
[Power Save Settings]	Refer to page 7-4.	Appears when user access is permitted under [Administrator Settings].
[Output Settings]	Refer to page 7-5.	
[AE Level Adjustment]	Refer to page 7-10.	

Settings

[Auto Paper Select for Small Original]	Specify the paper size to be used for a case where the original placed on the Original Glass is too small to be detected in Auto Paper mode.
[Copy on Small Size]	Prints on 5-1/2 × 8-1/2 (A5) size paper. <ul style="list-style-type: none"> If 5-1/2 × 8-1/2 (A5) size paper is not loaded in the tray, a message appears instructing you to load 5-1/2 × 8-1/2 (A5) size paper in the bypass tray.
[Copy on Letter] ([Copy on A4])	Prints on 8-1/2 × 11 (A4) size paper.
[Prohibit Copy]	Starts printing when a paper tray is selected manually and the Start key is pressed.
[Blank Page Print Settings]	Appears when user access is permitted under [Administrator Settings]. For details, refer to page 7-22.
[Page Number Print Position]	Specify a page number print position when printing page numbers after configuring 2-sided print or booklet settings. Select whether to print the page numbers on a same position on all pages or on positions symmetric with respect to the stapling position.
[Select Keyboard]	Select the keyboard type displayed by default in the Touch Panel .

Factory default

[Language Selection]	[English]
[Measurement Unit Settings]	This value varies depending on the area.
[Auto Tray Selection Settings]	[Tray Priority] [Tray 1] ▶▶ [Tray 2] ▶▶ [Tray 3] ▶▶ [Tray 4] When the optional paper tray is installed, [Tray 3] or [Tray 4] is displayed.
[Auto Tray Switch ON/OFF]	[Restrict]
[No Matching Paper in Tray Setting]	[Stop Printing (Tray Fixed)]
[Print Lists]	<ul style="list-style-type: none"> Tray 1 [1-Sided]
[Auto Color Level Adjust.]	Standard (3)
[Low Power Mode Settings]	15 min.
[Sleep Mode Settings]	20 min.
[Print/Fax Output Settings]	[Print]: [Page Print] [Fax]: [Batch Print]
[Output Tray Settings]	<ul style="list-style-type: none"> [Copy]: [Tray 2] [Print]: [Tray 2] [Print Reports]: [Tray 1] [Fax]: [Tray 1] [Output Tray Settings] is displayed when the Finisher FS-527 or Job Separator JS-505 is installed. [Tray 3] is displayed when the Job Separator JS-603 is installed in the Finisher FS-527 .
[AE Level Adjustment]	Standard (2)
[Auto Paper Select for Small Original]	[Prohibit Copy]
[Blank Page Print Settings]	[Do Not Print]
[Page Number Print Position]	[Left & Right Bind: All the Same Top & Bottom Bind: All the Same]
[Select Keyboard]	[Local Keyboard]

**Reference**

To enable Auto Paper:

Press [Basic] ▶▶ [Paper] ▶▶ [Auto].

To enable Auto Color:

Press [Basic] ▶▶ [Color] ▶▶ [Auto Color].

To configure Background Removal to Auto:

Press [Quality/Density] ▶▶ [Background Removal] ▶▶ [Auto].

6.2 [Custom Display Settings]

Change the touch panel display to the convenience of the user.

→ Press the **Utility/Counter** key ►►[User Settings] ►► [Custom Display Settings].



Settings

[Copier Settings]	[Default Tab]	Select either the standard Basic tab or the Quick Copy tab as the basic settings screen in Copy mode.
	[Shortcut Key 1]	Allows you to allocate shortcut keys for frequently used Application functions to be added to the basic settings screen. Pressing a shortcut key displays the desired setting screen. <ul style="list-style-type: none"> When the optional Image Controller IC-412 v1.1 is installed, only one shortcut key can be enabled.
	[Shortcut Key 2]	
	[Quick Settings 1]	Allows you to register setting conditions for frequently used copy functions and place them on the basic settings screen. The registered setting condition can be invoked by only pressing the corresponding easy setting key.
	[Quick Settings 2]	
	[Quick Settings 3]	
	[Quick Settings 4]	
[Default Tab Density Settings]	Specify whether to display the copy density setting in the basic settings screen. If [ON] is selected, you can press [Dark] or [Light] in the basic settings screen to adjust the copy density. <ul style="list-style-type: none"> If [ON] is selected, [Quick Settings 3] and [Quick Settings 4] cannot be specified. 	
[Scan/Fax Settings]	This setting is for the network scan, fax, and network fax operations. For details, refer to the [User's Guide Network Scan/Fax/Network Fax Operations].	
[User Box Settings]	Configure settings for the User Box operations. For details, refer to the [User's Guide Box Operations].	
[Copy Screen]	Configure whether to display the [Next Box Job], [Next Scan/Fax Job], or [Next Copy Job] button or messages when you program the next job during the printing operation.	
[FAX Active Screen]	This setting is for the fax and network fax operations. For details, refer to the [User's Guide Network Scan/Fax/Network Fax Operations].	
[Color Selection Settings]	Select the color used for indicating that the button is selected.	

Settings

[Left Panel Display Default]	[Left Panel Display Default]	Configure whether to display a list of jobs in process and in queue or to display the contents of the current Copy settings as the default display of the left panel.
	[Job Display Setting]	Configure whether to display a list of jobs in process and in queue or to display the progress of the current job in process, when the default display of the left panel set to [Job List].
[Search Option Settings]	This setting is for the network scan, fax, and network fax operations. For details, refer to the [User's Guide Network Scan/Fax/Network Fax Operations].	

Factory default

[Default Tab]	[Basic]
[Shortcut Key 1]/[Shortcut Key 2]/[Quick Settings 1]/[Quick Settings 2]/[Quick Settings 3]/[Quick Settings 4]	[OFF]
[Default Tab Density Settings]	[OFF]
[Default Tab] (Fax/Scan Settings)	[Address Book]
[Shortcut Key 1]/[Shortcut Key 2] (Fax/Scan Settings)	[OFF]
[Program Default] (Fax/Scan Settings)	[PAGE1]
[Address Book Index Default] (Fax/Scan Settings)	[Favorites]
[Default Address Book] (Fax/Scan Settings)	[Index]
[Default Address Type] (Fax/Scan Settings)	[Group]
[Default Tab] (User Box Settings)	[Public]
[Shortcut Key 1]/[Shortcut Key 2] (User Box Settings)	[OFF]
[Copy Operating Screen]	[No]
[Color Selection Settings]	[Green]
[Left Panel Display Default]	[Job List]
[Job Display Setting]	[List Display]
[Uppercase and Lowercase Letters]	[Differentiate]
[Search Option Screen]	[OFF]

6.3 [Copier Settings]

Configure the settings used by the copy functions.

→ Press the **Utility/Counter** key ►►[User Settings] ►► [Copier Settings].



Settings

[Auto Booklet ON when Fold & Staple]	Configure whether to automatically specify Booklet when Center Staple and Fold is selected. This item is displayed if the Saddle Stitcher SD-509 is installed in the Finisher FS-527 .	
[Auto Zoom for Combine/Booklet]	Configure whether the preset zoom ratios are automatically selected when Combine or Booklet is selected in Auto Paper mode. <ul style="list-style-type: none"> Select the recommended zoom ratios for the following zoom settings: 2 in 1, Booklet: 64.7% (70.7%) 4 in 1: 50.0% 8 in 1: 32.3% (35.3%) 	
[Auto Sort/Group Selection]	Configure whether to output the copied pages automatically in Sort mode when copying multiple-page original using the ADF .	
[Default Copy Settings]	Configure the initial values for the Copy function to be displayed when the power is turned on or the Reset key is pressed.	
	[Current Setting]	The current settings are used as the default settings.
	[Factory Default]	The factory settings are used as the default settings.
[Default Enlarge Display Settings]	This setting is for the enlarged display screen operations. For details, refer to the [User's Guide Enlarge Display Operations].	
[When AMS Direction is Incorrect]	Configure whether to print or discard the job when the original orientation does not match that of paper in Auto Zoom mode.	
[Separate Scan Output Method]	Configure the output for divided original loaded in the ADF or for multiple pages of the original scanned on the Original Glass .	
	[Page Print]	Printing of copies that can be printed begins while the original is being scanned.
	[Batch Print]	Printing begins after all pages of the original have been scanned.
[Enlargement Rotation]	Configure whether to rotate and print a large-size original image when the original orientation does not match that of paper.	
[Auto Zoom (Platen)]	Appears when user access is permitted under [Administrator Settings]. For details, refer to page 7-40.	
[Auto Zoom (ADF)]		
[Specify Default Tray when APS Off]		
[Select Tray for Insert Sheet]		

Settings

[Half-Fold Specification]	Specify whether to apply Half-Fold together for all pages or for each page when handling a job containing multiple pages. When Half-Hold is selected with Booklet, all pages are half-held together even if [One Sheet at a Time] is selected. This item is displayed if the Saddle Stitcher SD-509 is installed in the Finisher FS-527 .
[Print Jobs During Copy Operation]	Appears when user access is permitted under [Administrator Settings]. For details, refer to page 7-40.
[Automatic Image Rotation]	
[Finishing Program]	Configure whether to display the Finishing Program button in the basic settings screen. To display the button, register the contents of the finishing program. Register frequently used finishing functions so that you can set them at once by using the button that appears in the basic settings screen. This item is available if the Finisher FS-527 or Finisher FS-529 is installed.
[Card Shot Settings]	Appears when user access is permitted under [Administrator Settings]. For details, refer to page 7-40.

Factory default

[Auto Booklet ON when Fold & Staple]	[Auto Select Booklet]
[Auto Zoom for Combine/Booklet]	[Auto Display Zoom Ratio]
[Auto Sort/Group Selection]	[Yes]
[Default Copy Settings]	[Factory Default]
[When AMS Direction is Incorrect]	[Print]
[Separate Scan Output Method]	[Page Print]
[Enlargement Rotation]	[Allow]
[Auto Zoom (Platen)]	[OFF]
[Auto Zoom (ADF)]	[ON]
[Specify Default Tray when APS Off]	[Tray Before APS ON]
[Select Tray for Insert Sheet]	[Tray 2]
[Half-Fold Specification]	[Multiple Sheets]
[Print Jobs During Copy Operation]	[Accept]
[Automatic Image Rotation]	[When Auto Paper/Auto Zoom is set]
[Finishing Program]	[ON]
[Card Shot Settings]	- [Layout]: [Top/Bottom] - [Zoom]: [Full Size]

6.4 [Scan/Fax Settings]

This setting is for the network scan, fax, and network fax operations. For details, refer to the [User's Guide Network Scan/Fax/Network Fax Operations].

6.5 [Printer Settings]

This setting is for the printer operations. For details, refer to the [User's Guide Print Operations].

6.6 [Change Password]

Change the password for the user who is currently logged in.

✓ A public user cannot use this function.

1 Press the **Utility/Counter** key ►► [User Settings] ►► [Change Password].



2 Enter the previous password, and then press [OK].

3 Enter a new password.

4 Press [Password Confirmation], and enter the password again.

5 Press [OK].

The new password is registered.

6.7 [Change E-Mail Address]

Change the E-mail addresses specified as registered user information.

- ✓ When logged in as a registered user, you can change the E-mail address.
- ✓ Appears when user access is permitted under [Administrator Settings]. For details, refer to page 7-47.

- 1 Press the **Utility/Counter** key ►► [User Settings] ►► [Change E-Mail Address].

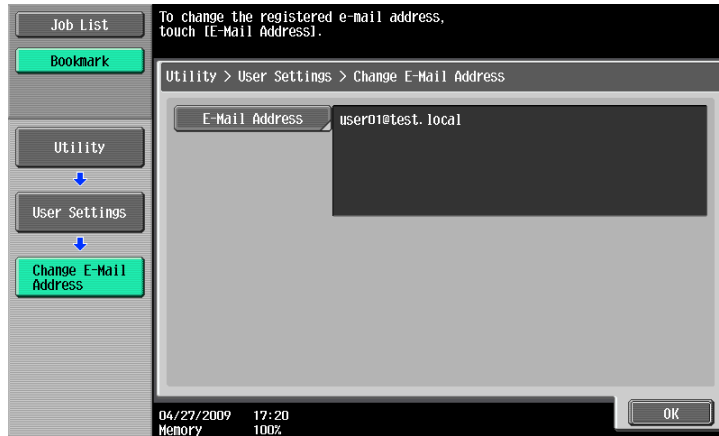

- 2 Press [E-Mail Address].
- 3 Change the E-mail address.
- 4 Press [OK].

6.8 [Change Icon]

Change the icon specified as registered user information.

✓ When logged in as a registered user, you can change the icon.

1 Press the **Utility/Counter** key ►► [User Settings] ►► [Change Icon].



2 Select the icon and press [OK].

6.9 [Register Authentication Information]

Register or delete the biometric authentication information or IC card authentication information about the registered users.

You can register or delete authentication information when performing the following operations.

- Select **Utility/Counter** ▶▶ [Administrator Settings] ▶▶ [System Settings] ▶▶ [Restrict User Access] ▶▶ [Restrict Access to Job Settings] ▶▶ [Biometric/IC Card Info. Registration] ▶▶ [Allow].
- Select **Utility/Counter** ▶▶ [Administrator Settings] ▶▶ [User Authentication/Account Track] ▶▶ [User Authentication Settings] ▶▶ [User Registration] ▶▶ [Function Permission] ▶▶ [Biometric/IC Card Info. Registration] ▶▶ [Allow].
- Log in as a registered user.

1 Press the **Utility/Counter** key ▶▶ [User Settings] ▶▶ [Register Authentication Information].

2 Press [Edit].

→ To delete authentication information, press [Delete].

For biometric authentication

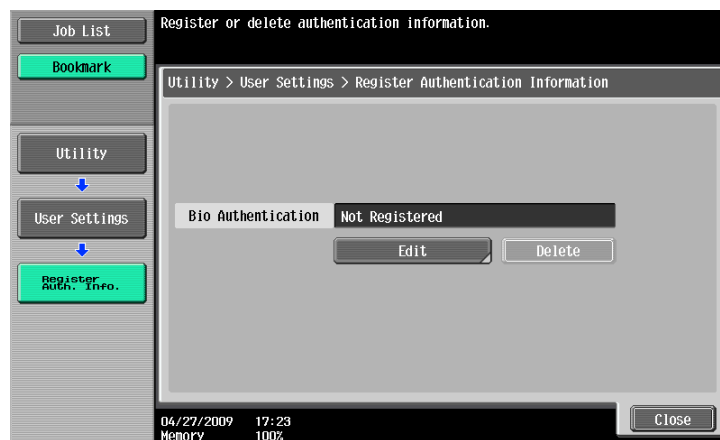

For IC card authentication

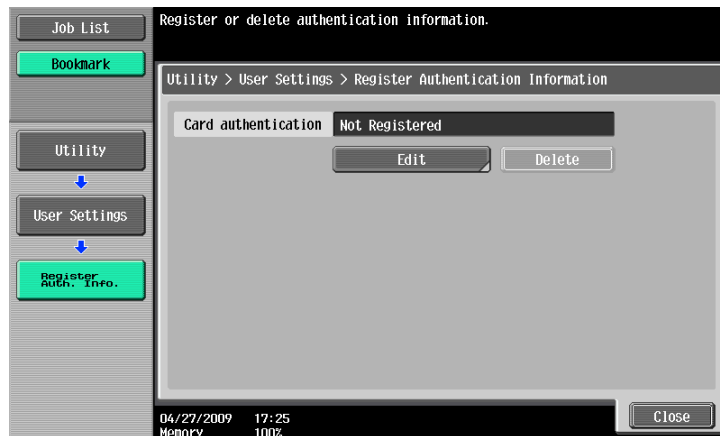

3 Register authentication information.

For biometric authentication, place your finger on the authentication unit to scan the finger vein pattern.

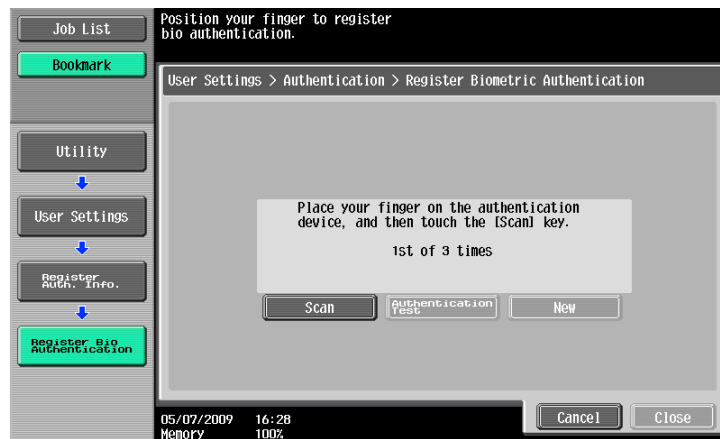

- Scan the finger vein pattern three times; reset the same finger each time and then press [Scan] for each scanning.
- After scanning the finger vein patterns, place the same finger on the authentication unit, and press [Authentication Test].
- If your finger vein patterns have been authenticated in the authentication test, press [New]. If authentication has failed, retry scanning the finger.

For IC card authentication, place your IC card on the authentication unit, and press [OK].



4 Press [Close].

6.10 [Cellular Phone/PDA Setting]

Configure settings to print data in a cellular phone or PDA through this machine. For details, refer to the [User's Guide Box Operations] or [User's Guide Print Operations].

7

[Administrator Settings]

7 [Administrator Settings]

[Administrator Settings] are used only by the administrator to adjust the settings. Logging on to Administrator Settings requires the administrator password.



Settings

[System Settings]	Configure the basic functions of this machine.
[Administrator/Machine Settings]	Register administrator information and E-mail address of this machine.
[One-Touch/User Box Registration]	Configure settings for the User Box, network scan, fax, and network fax operations.
[User Authentication/Account Track]	Configure the authentication settings to restrict the functions of this machine.
[Network Settings]	Configure network settings.
[Copier Settings]	Configure the settings for copy functions to be used in copy operations.
[Printer Settings]	Configure settings for the print operations.
[Fax Settings]	Configure settings for the fax and network fax operations.
[System Connection]	Configure settings for the software, cellular phone, or PDA that can be accessed with this machine.
[Security Settings]	Configure settings to restrict the functions of this machine for processing secret data.
[License Settings]	Enable an optional i-Option function.
[OpenAPI Authentication Management Setting]	Configure settings to prevent our deprecated OpenAPI connection application from being registered in this machine.

7.1 [System Settings]

Configure the basic functions of this machine.

7.1.1 [Power Save Settings]

Configure the settings for the power-saving mode.

- Press the **Utility/Counter** key ►► [Administrator Settings] ►► [System Settings] ►► [Power Save Settings].



Settings

[Low Power Mode Settings]	Enter a time period before switching to the lower power mode when this machine is not being operated.	
[Sleep Mode Settings]	Enter a time period before switching to the sleep mode when this machine is not being operated.	
[Power Save Key]	Configure the type of the power save function to be started when you press the Power Save key.	
	[Low Power]	Provides power-saving effect higher than normal.
[Sleep]	Provides power-saving effect higher than the low power mode. However, the machine must be warm-up when restarting operations, therefore taking more preparation time than the low power mode.	
[Enter Power Save Mode]	Configure settings for switching to the power save mode after printing documents from computers or receiving faxes.	
	[Normal]	Enters the power save mode when the time specified in Low Power Mode Settings has elapsed.
	[Immediately]	Enters the power save mode in a short time.

Factory default

[Low Power Mode Settings]	15 min.
[Sleep Mode Settings]	20 min.
[Power Save Key]	[Low Power]
[Enter Power Save Mode]	[Immediately]

7.1.2 [Output Settings]

Configure the settings for the output functions.

→ **Utility/Counter key** ► [Administrator Settings] ► [System Settings] ► [Output Settings].

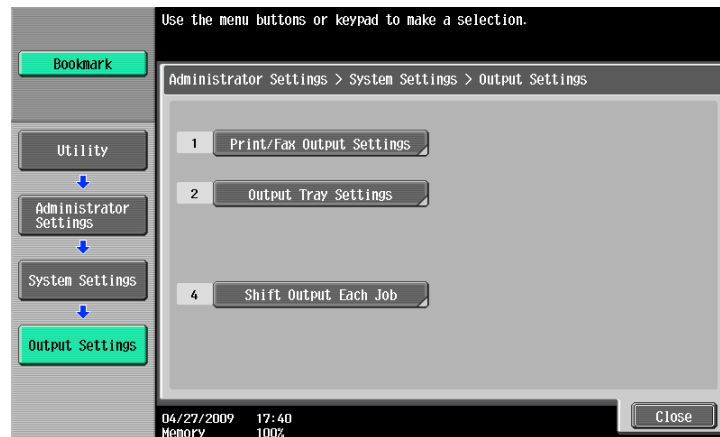

Settings

[Print/Fax Output Settings]	This setting is for the print and fax operations. For details, refer to the [User's Guide Network Scan/Fax/Network Fax Operations] and [User's Guide Print Operations].
[Output Tray Settings]	Configure an output tray given priority for outputting by function. This item is displayed if the Finisher FS-527 or Job Separator JS-505 is installed.
[Shift Output Each Job]	Select whether to shift the output paper for each job. This item is displayed if the Finisher FS-527 , Finisher FS-529 , or Job Separator JS-505 is installed:

Factory default

[Print/Fax Output Settings]	[Print]: [Page Print] [Fax]: [Batch Print]
[Output Tray Settings]	<ul style="list-style-type: none"> • [Copy]: [Tray 2] • [Print]: [Tray 2] • [Print Reports]: [Tray 1] • [Fax]: [Tray 1] [Tray 1] is displayed if the Job Separator JS-603 is installed in the Finisher FS-527 .
[Shift Output Each Job]	[Yes]

7.1.3 [Date/Time Settings]

Configure the current date and time and the time zone.

→ Press the **Utility/Counter** key ►► [Administrator Settings] ►► [System Settings] ►► [Date/Time Settings].



Settings

[Year]	Configure the current date and time.
[Monthly]	
[Daily]	
[Hour]	
[Minute]	
[Time Zone]	Configure the UTC (Coordinate Universal Time) related time zone.

Factory default

[Time Zone]	+00:00
-------------	--------



Reference

To cancel the current settings:

Press **C** (Clear).

7.1.4 [Daylight Saving Time]

Configure daylight saving time settings.

- ✓ This function is available when this machine is connected to the network where UTC (Coordinate Universal Time) is specified. For details, refer to the [User's Guide Network Administrator].

- Press the **Utility/Counter** key ► [Administrator Settings] ► [System Settings] ► [Daylight Saving Time].



Settings

Configure whether to use daylight saving time and the time difference from UTC (Coordinate Universal Time).

Factory default

[Daylight Saving Time]	[No]
------------------------	------

7.1.5 [Weekly Timer Settings]

Configure the weekly timer in order to allow you to turn on and off this machine at the specified date and time.

- ✓ An exact date/time setting must be performed in advance.

- Press the **Utility/Counter** key ► [Administrator Settings] ► [System Settings] ► [Weekly Timer Settings].

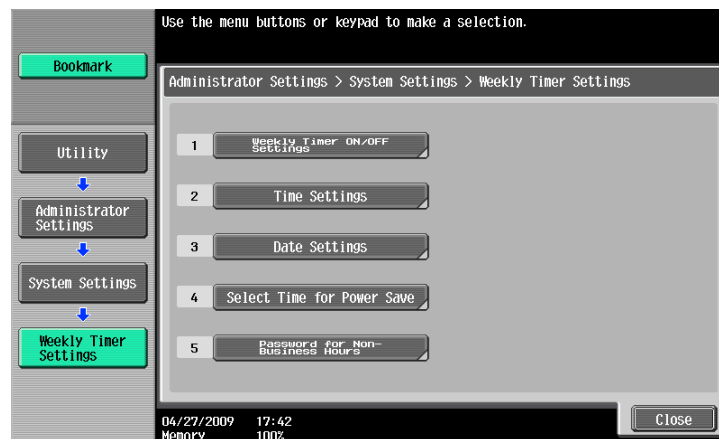

Settings

[Weekly Timer ON/OFF Settings]	Configure whether to use the weekly timer function.	
[Time Settings]	Configure the time of each day of the week to turn on and off this machine.	
	[Set All]	The setting for the selected day of the week is applied to the same day of the week in other weeks.
	[Delete]	Cancels the selected input value.
[Date Settings]	Configure the days when timer operation is activated individually. To cancel the setting, press the same day again.	
	[Daily Setting]	Configure the days of the week when the timer operation is activated.

Settings

[Select Time for Power Save]	Configure the time to turn this machine off and on if you want to turn it off at a specific time, for example, during a lunch break.
[Password for Non-Business Hours]	Configure whether to require a user to enter the password if the user uses this machine outside the specified time. <ul style="list-style-type: none"> To make the user to enter the password, you need to specify the password.

Factory default

[Weekly Timer ON/OFF Settings]	[OFF]
[Select Time for Power Save]	[No]
[Password for Non-Business Hours]	[No]

7.1.6 [Restrict User Access]

Restrict the machine operation, or change or delete the copy programs by the user.

➔ Press the **Utility/Counter** key ➔ [Administrator Settings] ➔ [System Settings] ➔ [Restrict User Access].

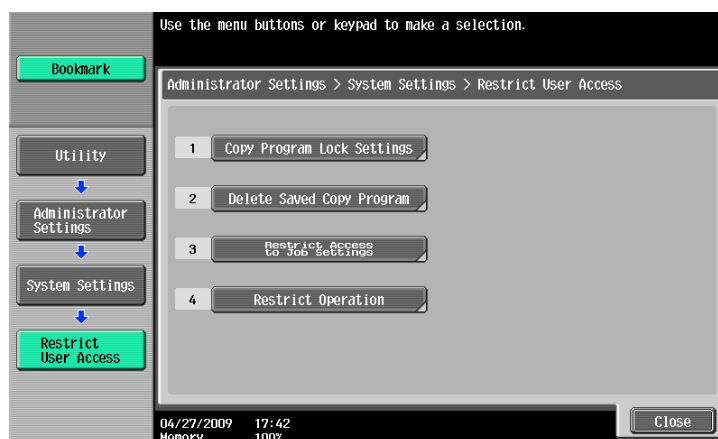

Settings

[Copy Program Lock Settings]	Configure the registered copy programs that are prevented from being changed or deleted.
[Delete Saved Copy Program]	Delete the registered copy programs.

Settings

[Restrict Access to Job Settings]	Configure whether to allow users to configure the following settings.	
	[Changing Job Priority]	Configure whether to allow users to change the print priority of jobs.
	[Delete Other User Jobs]	Configure whether to allow other users to delete jobs when the user authentication settings have been specified.
	[Registering and Changing Addresses]	This setting is for the network scan, fax, and network fax operations. For details, refer to the [User's Guide Network Scan/Fax/Network Fax Operations].
	[Changing Zoom Ratio]	Configure whether to allow users to change registered zoom ratios.
	[Change the "From" Address]	This setting is for the network scan operations. For details, refer to the [User's Guide Network Scan/Fax/Network Fax Operations].
	[Change Registered Overlay]	Configure whether to allow users to change registered image overlays.
	[Biometric/IC Card Info. Registration]	Configure whether to allow a registered user to register or delete biometric authentication information or IC card authentication information of the user.
[Restrict Operation]	[Restrict Broadcasting]	This setting is for the network scan, fax, and network fax operations. For details, refer to the [User's Guide Network Scan/Fax/Network Fax Operations].

Factory default

[Changing Job Priority]	[Allow]
[Delete Other User Jobs]	[Restrict]
[Registering and Changing Addresses]	[Allow]
[Changing Zoom Ratio]	[Allow]
[Change the "From" Address]	[Login User Address]
[Change Registered Overlay]	[Allow]
[Biometric/IC Card Info. Registration]	[Restrict]
[Restrict Broadcasting]	[OFF]



7.1.7 [Expert Adjustment]

Make adjustments so that output quality is increased.

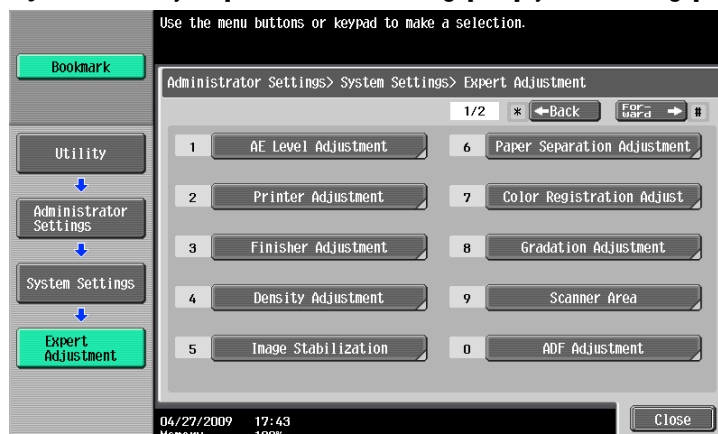
→ Press the **Utility/Counter** key ►► [Administrator Settings] ►► [System Settings] ►► [Expert Adjustment].



Settings

[AE Level Adjustment]	Configure the initial value for AE (auto exposure). The higher the setting, the more that the original background is emphasized.
[Printer Adjustment]	Adjust the starting print position and defective print images caused by paper type features. <div style="text-align: center;">  Reference <i>The starting print position is factory-adjusted. Normally, you are not required to change the set values.</i> </div>
[Leading Edge Adjustment]	p. 7-13
[Centering]	p. 7-13
[Leading Edge Adjustment (Duplex Side 2)]	p. 7-13
[Centering (Duplex 2nd Side)]	p. 7-13
[Erase Leading Edge]	Adjust leading edge erase width. For details on displaying this item, contact your service representative.
[Vertical Adjustment]	Adjust the feed direction zoom ratio of paper types. For details on displaying this item, contact your service representative.
[Media Adjustment]	p. 7-14
[Finisher Adjustment]	Adjust the staple, folding, and punch position of the Finisher FS-527 . Otherwise, adjust where to place the paper alignment plate of the Finisher FS-529 . This item is displayed if the Finisher FS-527 or Finisher FS-529 is installed. <div style="text-align: center;">  Reference <i>Create a sample in advance, and then adjust them while checking the sample.</i> </div>
[Center Staple Position]	p. 7-14
[Half-Fold Position]	p. 7-15
[Punch Horizontal Position Adjustment]	p. 7-15
[Punch Regist Loop Size Adjustment]	p. 7-16
[Paper Alignment Plate Settings]	p. 7-16

Settings		
[Density Adjustment]	Correct the toner amount to be used by color depending on the paper type. <ul style="list-style-type: none"> To correct the toner amount to be used in the black print mode, press [Black Image Density]. 	
[Image Stabilization]	[Image Stabilization Only]	Press the Start key to stabilize images. Pressing the [Image Stabilization Only] button executes normal image stabilization. If a good result was not achieved after the [Image Stabilization Only] button was pressed, execute [Initialize + Image Stabilization].
	[Image Stabilization Setting]	Specify the type and opportunity of image stabilization. If [Standard] is selected, normal stabilization is performed during warm-up processing when a change in the absolute humidity has been detected during warm-up processing. If [Color Priority] is selected, color stabilization is performed when the power has been turned on. Selecting [Black & White Priority] executes monochrome stabilization during warm-up when absolute humidity change is detected during the warm-up, and then stabilizes color before performing color print.
[Paper Separation Adjustment]	Adjust the paper position where the two sides are separated for 2-sided print.	
[Color Registration Adjust]	Correct color shifts if they are detected in the print result. For details, refer to page 7-16.	
[Gradation Adjustment]	Adjust irregular gradation levels of print images. For details, refer to page 7-17.	
	[Image Stabilization Only]	Stabilize the image by pressing the Start key before performing gradation adjustment.
	[Print]	Adjust the gradation when the color gradation has been changed in a print image. This function performs adjustment, emphasizing the gradation expression of an image and the reproducibility of texts or lines.
	[Copy]	Adjust the gradation when the color gradation has been changed in a print image. This function performs adjustment to save as many images as possible in memory.
[Scanner Area]	Adjust the scan range of the scanner. For details on displaying this item, contact your service representative.	
[ADF Adjustment]	Make adjustments for scanning images in the ADF . For details on displaying this item, contact your service representative.	
[Line Detection]	[Prior Detection Setting]	Configure whether to issue an alert when the Slit Scan Glass is dirty. <ul style="list-style-type: none"> Select an alert display format and contamination detection level.
	[Feed Cleaning Settings]	Configure whether to remove a dirt on the Slit Scan Glass each time one sheet of paper passes through the ADF when scanning an original using the ADF .

Settings

[User Paper Settings]	Configure special paper settings for [User Paper 1] through [User Paper 5]. Settings to configure include Basic Weight and Media Adjustment. For details on displaying this item, contact your service representative.	
[Erase Adjustment]	[Non-Image Area Erase Operation Settings]	Configure Non-Image Area operation settings. [Auto]: Automatically detects the background density of the original, and selects either [Bevel] or [Rectangular] accordingly. [Specify]: Allows you to manually specify an erase method and original density. As an erase method, select [Bevel] or [Rectangular]. Specify an original density from five levels.

Factory default

[AE Level Adjustment]	Standard (2)
[Leading Edge Adjustment]	0.0 mm
[Centering]	0.0 mm
[Leading Edge Adjustment (Duplex Side 2)]	0.0 mm
[Centering (Duplex 2nd Side)]	0.0 mm
[Media Adjustment]	[Auto]
[Center Staple Position]	0.0 mm
[Half-Fold Position]	0.0 mm
[Punch Horizontal Position Adjustment]	0
[Punch Regist Loop Size Adjustment]	0
[Paper Alignment Plate Settings]	0.0 mm
[Density Adjustment]	0
[Image Stabilization Only]	[Image Stabilization Only]
[Image Stabilization Setting]	[Standard]
[Paper Separation Adjustment]	0.0 mm
[Color Registration Adjust]	0 dot
[Prior Detection Setting]	[Yes] [Warning Display]: [TYPE2] [Detection level]: [Std.]
[Feed Cleaning Settings]	[Clean]
[Non-Image Area Erase Operation Settings]	[Erase Operation]: [Specify] [Erase Method]: [Rectangular] [Original Density]: [1]

[Leading Edge Adjustment]

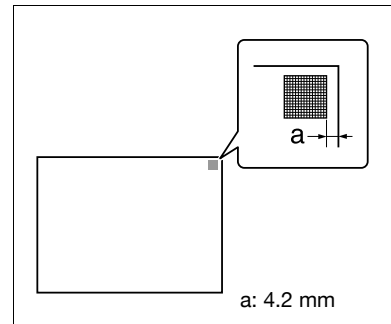

Adjust the starting print position at the leading edge of each type of paper (with respect to the paper feed direction).

- 1 Press the **Utility/Counter** key ►► [Administrator Settings] ►► [System Settings] ►► [Expert Adjustment] ►► [Printer Adjustment] ►► [Leading Edge Adjustment].
 - To adjust the starting print position at the leading edge of the second side for 2-sided printing (with respect to the paper feed direction), press [Leading Edge Adjustment (Duplex Side 2)].
- 2 Select a paper type to be adjusted.
- 3 Load the paper into the **Bypass Tray**.
- 4 Press the **Start** key.
A test pattern is printed.
- 5 Check that the distance from the starting print position of the test pattern to the edge of the paper (a) is 4.2 mm.
 - Press [+] or [-] to adjust the width.
Press the **Start** key to print a test pattern.
- 6 Press [OK].



[Centering]

Adjust the starting print position at the left edge of each paper tray (with respect to the paper feed direction).

- ✓ Only 8-1/2 × 11  (A4 ) paper can be used to adjust the **Bypass Tray**.
- 1 Press the **Utility/Counter** key ►► [Administrator Settings] ►► [System Settings] ►► [Expert Adjustment] ►► [Printer Adjustment] ►► [Centering].
 - To adjust the starting print position at the left edge of the second side for 2-sided printing (with respect to the paper feed direction), press [Centering (Duplex 2nd Side)].
 - 2 Select a paper tray to be adjusted.
 - 3 Press the **Start** key.
A test pattern is printed.
 - 4 Check that the distance from the starting print position of the test pattern to the left edge of the paper (b) is 3.0 mm (±0.5 mm).
 - Press [+] or [-] to adjust the width.
Press the **Start** key to print a test pattern.
 - 5 Press [OK].

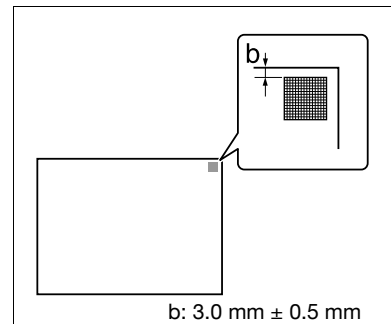

[Media Adjustment]

Adjust defective print images caused by paper type features.

- 1 Press the **Utility/Counter** key ►► [Administrator Settings] ►► [System Settings] ►► [Expert Adjustment] ►► [Printer Adjustment] ►► [Media Adjustment].
- 2 Select a paper type to be adjusted.
 - If defective images exist on the back side of 2-sided copy paper, select [2nd Side].
- 3 Press [+] or [-] to specify an adjusted value.
 - If missing parts or white spots exist in print images, press [-]. If the surface of the print image is rough, press [+].
- 4 Press [OK] ►► [Close].
- 5 Copy, and then check the print image.

[Center Staple Position]

Adjust the stapling position for each paper size when printing with the center staple function.

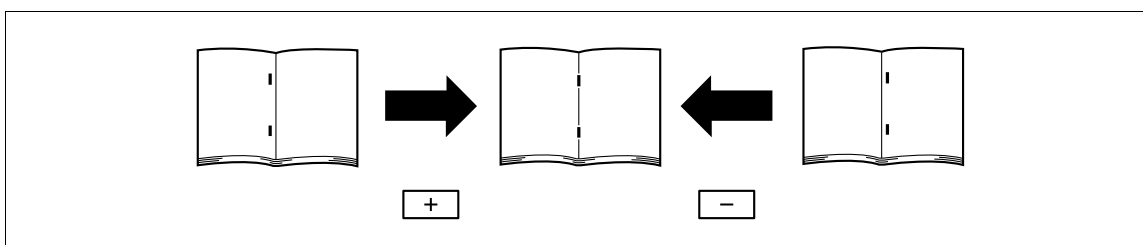

- ✓ Adjust the half-fold position before adjusting the center stapling position.
 - ✓ Before making any adjustments, create a sample using the center staple function. Adjust the center staple position while checking the created sample.
 - ✓ This adjustment is available if the **Saddle Stitcher SD-509** is installed.
 - ✓ When stapling in parallel with the left edge of paper, contact your service representative.
- 1 Press the **Utility/Counter** key ►► [Administrator Settings] ►► [System Settings] ►► [Expert Adjustment] ►► [Finisher Adjustment] ►► [Center Staple Position].
 - 2 Select the size of paper of which the center staple position is adjusted.
 - 3 Press [+] or [-] to adjust the staple position while checking the sample.
 - 4 Press [OK].
 - 5 Create a sample, and check the print result.



Reference

To adjust the half-fold position:

Press the **Utility/Counter** key ►► [Administrator Settings] ►► [System Settings] ►► [Expert Adjustment] ►► [Finisher Adjustment] ►► [Half-Fold Position].

[Half-Fold Position]

Adjust the center staple & fold and half-fold positions for each paper size.

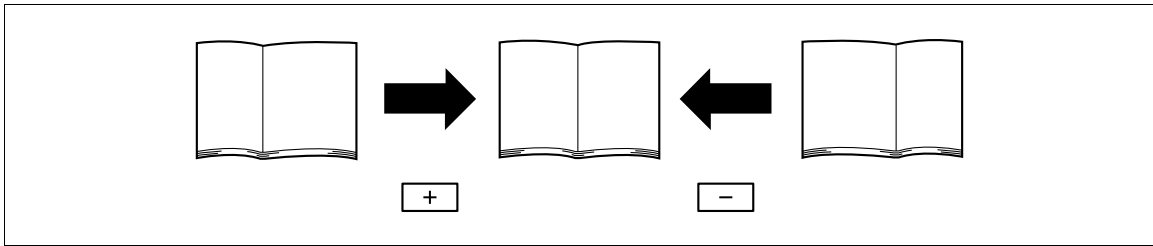

- ✓ Before making any adjustments, create a sample using the half-fold function. Adjust the center staple position while checking the created sample.
- ✓ This adjustment is available if the **Saddle Stitcher SD-509** is installed.
- ✓ When adjusting the half-fold position in parallel with the left edge of paper, contact your service representative.

- 1 Press the **Utility/Counter** key ►► [Administrator Settings] ►► [System Settings] ►► [Expert Adjustment] ►► [Finisher Adjustment] ►► [Half-Fold Position].
- 2 Select the size of paper of which half-fold position is adjusted.
- 3 Press [+] or [-] to adjust the half-fold position while checking the sample.
- 4 Press [OK].
- 5 Create a sample, and check the print result.

[Punch Horizontal Position Adjustment]

Adjust the horizontal position of the punched holes for each paper type.

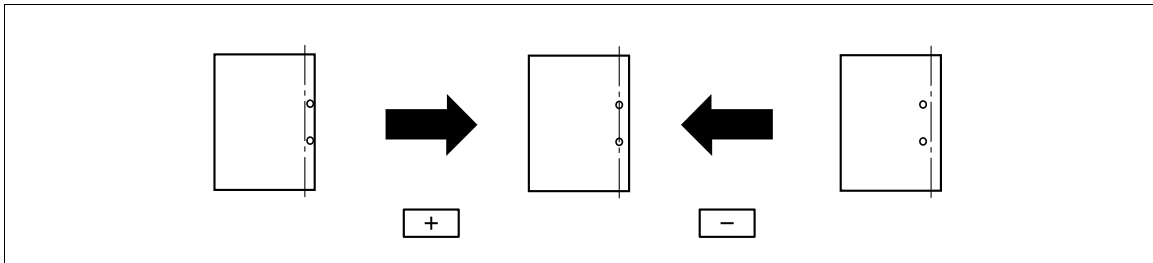

- ✓ Before making any adjustments, create a sample using the punch settings. Adjust the center staple position while checking the created sample.
- ✓ This adjustment is available if the **Punch Kit PK-517** is installed.

- 1 Press **Utility/Counter** ►► [Administrator Settings] ►► [System Settings] ►► [Expert Adjustment] ►► [Finisher Adjustment] ►► [Punch Horizontal Position Adjustment].
- 2 Select the type of paper of which the horizontal punched hole position is adjusted.
- 3 Press [+] or [-] to adjust the punched hole position while checking the sample.
- 4 Press [OK].
- 5 Create a sample, and check the print result.

[Punch Regist Loop Size Adjustment]

Correct the orientation of the paper and adjust the punched hole position to be parallel with the left edge of the paper. The angle of the punched hole is corrected by adjusting the resistance applied to the paper for each paper type.

- ✓ This adjustment is available if the **Punch Kit PK-517** is installed.
- 1 Press the **Utility/Counter** key ►► [Administrator Settings] ►► [System Settings] ►► [Expert Adjustment] ►► [Finisher Adjustment] ►► [Punch Regist Loop Size Adjustment].
- 2 Select a paper type for which the punched hole angle is adjusted.
- 3 Press [+] or [-] to adjust the punch position.
- 4 Press [OK].
- 5 Create a sample, and check the print result.





[Paper Alignment Plate Settings]

Adjust the width of the paper alignment plate to align the output sheets of paper.

- ✓ This item is available if the **Finisher FS-529** is installed.
- 1 Press **Utility/Counter**►►[Administrator Settings]►►[System Settings]►►[Expert Adjustment]►►[Finisher Adjustment]►►[Paper Alignment Plate Settings].
- 2 Select the paper alignment plate position.
- 3 Press [+] or [-] to adjust the position.
- 4 Press [OK].

[Color Registration Adjust]

If color shifts are detected in the print result, adjust the each color print position for each paper type.

- ✓ The procedure for adjusting the color registration is the same for yellow, magenta and cyan.
- 1 Press the **Utility/Counter** key ►► [Administrator Settings] ►► [System Settings] ►► [Expert Adjustment] ►► [Color Registration Adjust].
- 2 Select a color to be corrected.
- 3 Select a paper type for which color registration is adjusted.
- 4 Load the paper into the **Bypass Tray**.
 - The loadable paper size is 11 × 17 , 8-1/2 × 11 , A3 , or A4 .
- 5 Press the **Start** key.

A test pattern is printed.

- 6 Check that the black line aligns with the color line to be adjusted at the X and Y positions of the test pattern.

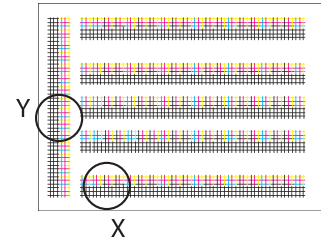

→ Press [+] or [-] to adjust the color line to be corrected while checking the sample.

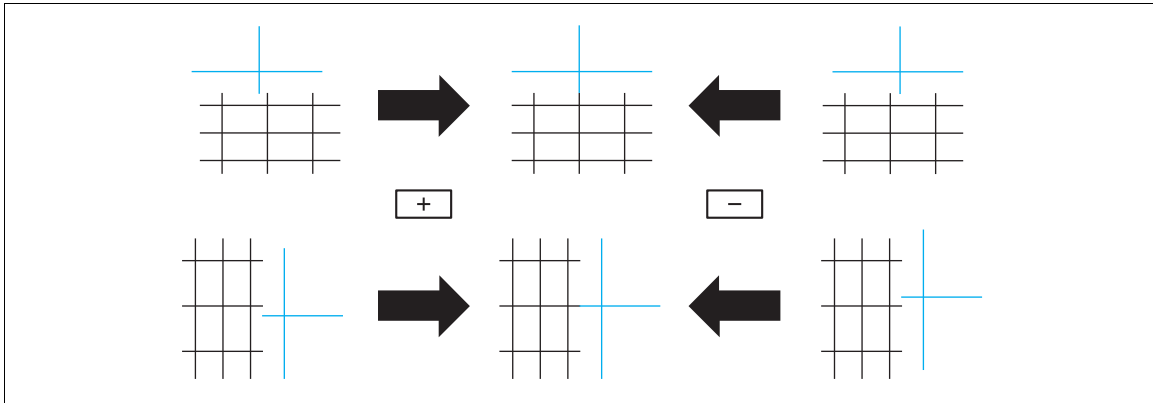

The color registration is adjusted.

- 7 Press the **Start** key to print a test pattern, and then check the print result.
- 8 Press [OK].

[Gradation Adjustment]





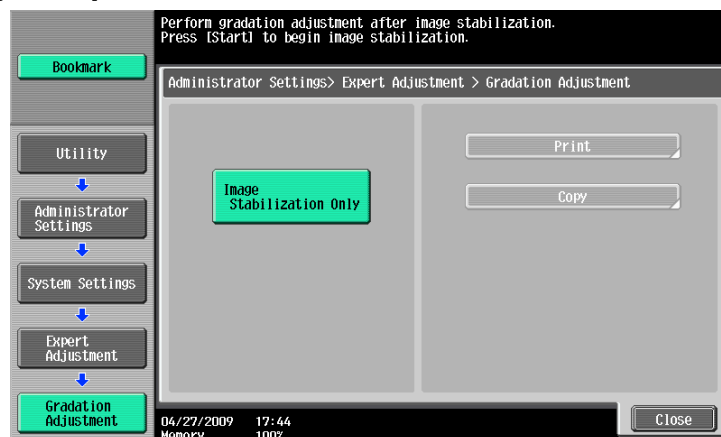

Adjust irregular gradation levels of print images.

- ✓ Adjust each correction item three times.







- 1 Turn off the **Main Power Switch** of this machine.
- 2 Wait at least 10 seconds, and then turn it on again.
- 3 Press the **Utility/Counter** key ►► [Administrator Settings] ►► [System Settings] ►► [Expert Adjustment] ►► [Gradation Adjustment].



- 4 Press the **Start** key.
The image stabilization operation starts.
The correction items on the **Touch Panel** become enabled.

- 5 Select an item to be corrected.
- 6 Select paper used to output a test pattern.
 - As a paper size, select 11 × 17 , 8-1/2 × 11 , A3 , or A4 . By default, 11 × 17  (A3 ) is selected.
 - Paper in the **Bypass Tray** cannot be selected.
- 7 Press the **Start** key.

A test pattern is printed.

 - Selecting 11 × 17  or A3  outputs one sheet, and selecting 8-1/2 × 11  or A4  outputs two sheets.
- 8 Place the printed test pattern on the **Touch Panel** in the orientation displayed in the **Original Glass**.
 - For the test patterns of 8-1/2 × 11  or A4 , place two output sheets side by side.
- 9 Place 10 or more sheets of blank paper on top of the test pattern to prevent it from becoming transparent.
- 10 Close the **ADF** or **Original Cover**.
- 11 Press the **Start** key.

The test pattern is scanned.

The gradation level is automatically adjusted.
- 12 Repeat steps 5 through 11 two more times.

7.1.8 [List/Counter]

Configure the job settings list print settings and paper count settings for this machine.

- Press the **Utility/Counter** key ►► [Administrator Settings] ►► [System Settings] ►► [List/Counter].

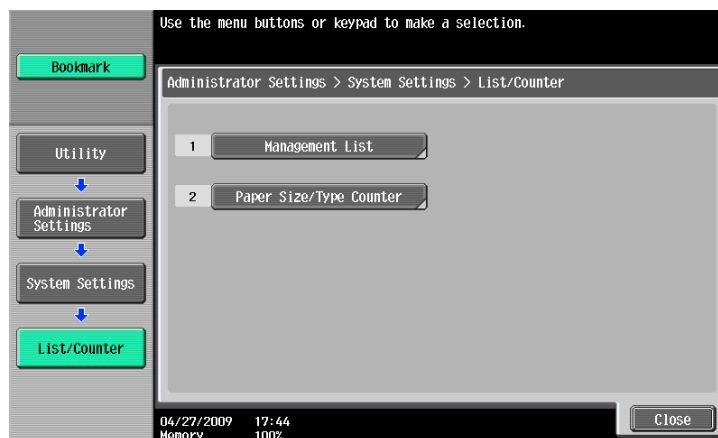

Settings

[Management List]	[Job Settings List]	Configure paper tray settings for printing the job settings list and specify a print side.
[Paper Size/Type Counter]	Register a combination of paper size and paper type for a counter to count the number. Every time the counter is changed, the count is reset to 0.	
	[Counter Clear]	Resets the count to 0.
	[Paper Size]	Select the paper size of the counter.
	[Paper Type]	Select the paper type of the counter.

Factory default

[Job Settings List]	<ul style="list-style-type: none"> • [1-Sided] • Tray 1
---------------------	---

7.1.9 [Reset Settings]

Configure auto reset settings.

- ✓ All settings performed in the following tabs during operation using the copy function are automatically reset to the initial settings after the specified time has elapsed.
[Basic], [Original Setting], [Quality/Density], [Application]
- ✓ Even if [OFF] is selected for System Auto Reset Time, the system auto reset function operates when this machine is not used for one minute during user authentication/account track operations.

➔ Press the **Utility/Counter** key ➤ [Administrator Settings] ➤ [System Settings] ➤ [Reset Settings].

**Settings**

[System Auto Reset]	[Priority Mode]	Configure a mode to be displayed in the system auto reset mode.
	[System Auto Reset Time]	Configure whether to perform system auto reset. Specify a time until the initial screen appears if this machine is not operated. The specified time is not canceled. <div style="text-align: center;">  Reference <i>If user authentication or enhanced security mode is enabled, the administrator settings mode or user authentication mode is logged off according to the setting for System Auto Reset Time.</i> <i>In the enlarge display mode, the system auto reset mode is disabled.</i> </div>
[Auto Reset]	Configure whether to perform auto reset in the selected mode. Specify a time until the basic settings screen appears and the settings are reset to the initial values if this machine is not operated.	
[Job Reset]	[When Account is changed]	Configure whether to reset the settings when you log off if the user authentication or account track settings have been configured.
	[When original is set on ADF]	Configure whether to reset the settings when an original is loaded in the ADF .
	[Next Job]	Configure whether to reset the following settings when the next job is selected. <ul style="list-style-type: none"> • [Staple Setting] • [Original Set/Bind Direction] • [Reset Data After Job] The destination of data is always reset.

Factory default

[Priority Mode]	[Copy]
[System Auto Reset Time]	1 minute
[Auto Reset]	<ul style="list-style-type: none"> • [Copy]: 1 Minute • [Scan/Fax]: 1 Minute • [User Box]: 1 Minute
[When Account is changed]	[Reset]
[When original is set on ADF]	[Do Not Reset]
[Next Job]	<ul style="list-style-type: none"> • [Staple Setting]: [OFF] • [Original Set/Bind Direction]: [OFF] • [Reset Data After Job]: [Reset All]

**Reference**

To configure user authentication/account track:

Press the **Utility/Counter** key ►► [Administrator Settings] ►► [User Authentication/Account Track] ►► [General Settings].

7.1.10 [User Box Settings]

This setting is for the User Box functions. For details, refer to the [User's Guide Box Operations].

7.1.11 [Standard Size Setting]

Configure settings relating to the capability for detecting original size and the foolscap paper sizes.

For details on displaying this item, contact your service representative.

➔ Press the **Utility/Counter** key ►► [Administrator Settings] ►► [System Settings] ►► [Standard Size Setting].

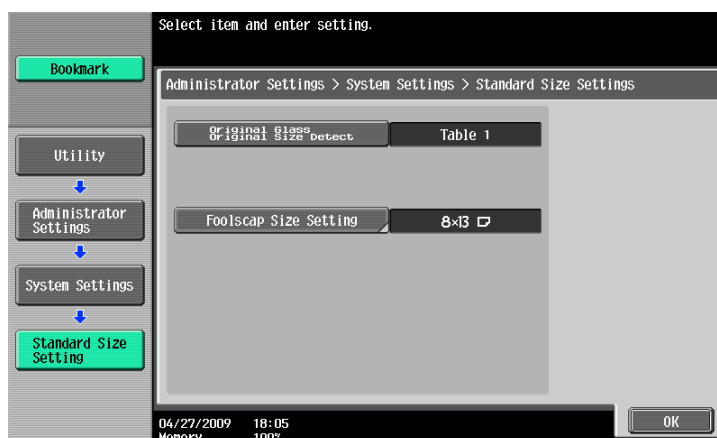
**Settings**

[Original Glass Original Size Detect]	Configure the capability for detecting original sizes.
[8 1/2×14/Foolscap Size Detection] (Metric area only)	Specify whether to detect a size of 8-1/2 × 14 or a foolscap size.
[Foolscap Size Setting]	Select the size that you want to use when the paper size is close to 13 inches.

Factory default

[Original Glass Original Size Detect]	[Table 1]
[8 1/2×14/Foolscap Size Detection]	[8 1/2 × 14]
[Foolscap Size Setting]	[8 × 13 

7.1.12 [Stamp Settings]

Configure header and footer settings to be printed.

→ Press the **Utility/Counter** key ► [Administrator Settings] ► [System Settings] ► [Stamp Settings].

**Settings**

[Header/Footer Settings]	Register or change a header and footer. To use the header/footer function in Application Setting, a header and footer must be registered in advance.	
	[New]	Enter a registration name, and then configure detailed header and footer settings. Configure whether to print a header and footer, and then configure print contents. <ul style="list-style-type: none"> • [Text]: Enter text. • [Date/Time]: Select a format to display the date and time. • [Other]: Specify the distribution control number. Select whether to include the Job Number, Serial Number, and Account/User Name. Configure pages and text details. <ul style="list-style-type: none"> • [Pages]: Select whether to print the header and footer on all pages or only on the first page. • [Text Details]: Select the color, size, and type of the text for the header and footer to be printed.
	[Delete]	Deletes the selected header or footer.
	[Check/Edit]	Change the selected header or footer.
[Fax TX Settings]	This setting is for the fax and network fax operations. For details, refer to the [User's Guide Network Scan/Fax/Network Fax Operations].	

Factory default

[Fax TX Settings]	[Cancel]
-------------------	----------

7.1.13 [Blank Page Print Settings]

Configure whether to print stamps or overlay on blank pages.

- Press the **Utility/Counter** key ► [Administrator Settings] ► [System Settings] ► [Blank Page Print Settings].

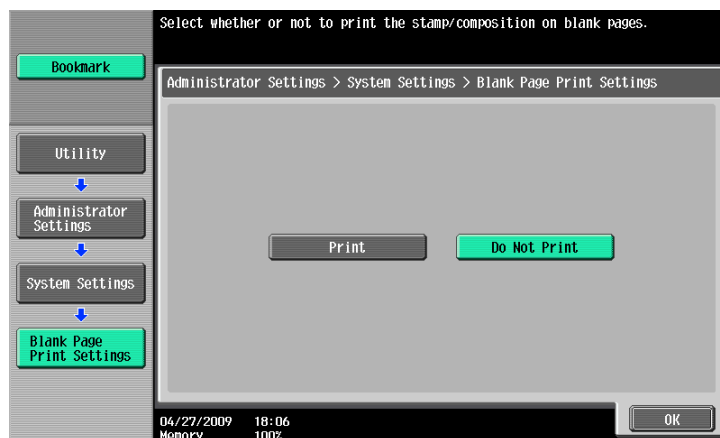

Settings

Configure whether to print stamp/composition on blank pages.

Factory default

[Blank Page Print Settings] | [Do Not Print]

7.1.14 [Skip Job Operation Settings]

Configure whether to start processing for the next job when the current job stops due to running out of paper in the paper tray. Selecting [Yes] provides no print queue time due to job stopping.

- Press the **Utility/Counter** key ► [Administrator Settings] ► [System Settings] ► [Skip Job Operation Settings].

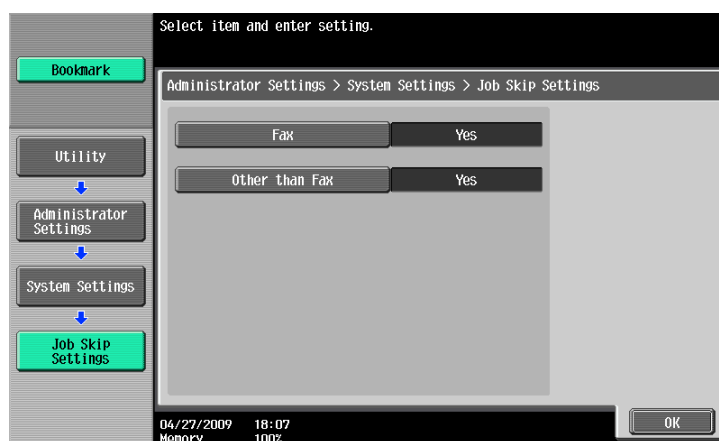

Settings

[Fax]	Configure whether to skip a job in the fax mode.
[Other than Fax]	Configure whether to skip a job in a mode other than the fax mode.

Factory default

[Skip Job Operation Settings]	[Fax]: [Yes] [Other than Fax]: [Yes]
-------------------------------	---

7.1.15 [Default Bypass Paper Type Setting]

Configure the initial settings for the paper type to be used for the bypass tray. The initial setting for the paper type is applied after the job finishes or the tray runs out of paper.

- Press **Utility/Counter**▶▶[Administrator Settings]▶▶[System Settings]▶▶[Default Bypass Paper Type Setting].



Settings

Configure whether to specify the initial setting for paper type for the bypass tray. When you specified this, select a paper type.

Factory default

[Default Bypass Paper Type Setting]	[Yes] [Paper Type]: [Plain Paper]
-------------------------------------	--------------------------------------

7.1.16 [Page Number Print Position]

Specify a page number print position when printing page numbers after configuring 2-sided print or booklet settings. Select whether to print the page numbers on a same position on all pages or on positions symmetric with respect to the stapling position.

→ Press the **Utility/Counter** key ►► [Administrator Settings] ►► [System Settings] ►► [Page Number Print Position].

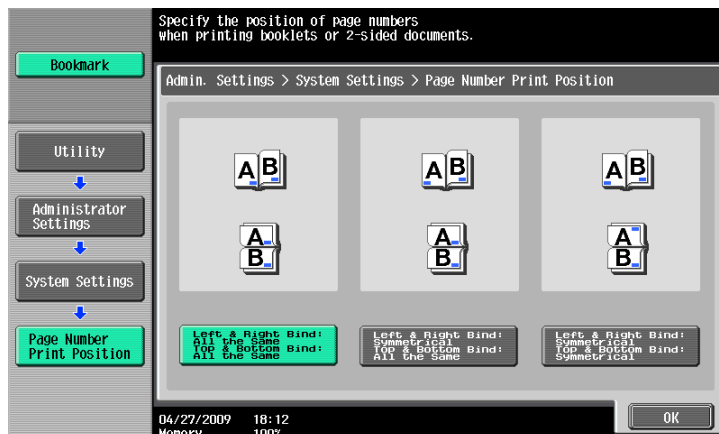

Settings

[Left & Right Bind: All the Same
Top & Bottom Bind: All the Same]

Select a desired print position.

[Left & Right Bind: Symmetrical
Top & Bottom Bind: All the Same]

[Left & Right Bind: Symmetrical
Top & Bottom Bind: Symmetrical]

Factory default

[Page Number Print Position]

[Left & Right Bind: All the Same Top & Bottom Bind: All the Same]

7.1.17 [Advanced Preview Setting]

Configure settings to fax or scan a document. For details, refer to the [User's Guide Network Scan/Fax/Network Fax Operations].

7.2 [Administrator/Machine Settings]

Register administrator information and E-mail address of this machine.

- ✓ The device name entered under the Input Machine Address may not be supported by your operating system.

➔ Press the **Utility/Counter** key ➔ [Administrator Settings] ➔ [Administrator/Machine Settings].

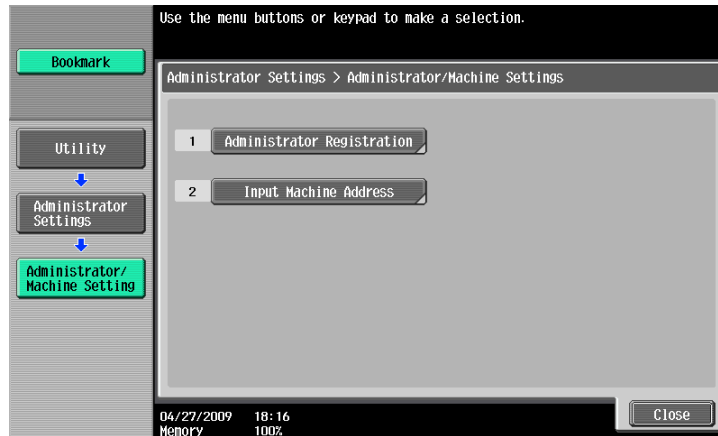

Settings

[Administrator Registration]	Register administrator information displayed on the Service/Admin. Information screen of the Guidance screen and the From address for sending E-mail from this machine.
[Input Machine Address]	Register the device name and E-mail address of this machine. The device name is used as a part of the name of the file created on this machine. The E-mail address can be used for Internet fax.

Factory default

[Device Name]	The default abbreviation is input for the product name. If necessary, it can be changed freely.
---------------	---

7.3 [One-Touch/User Box Registration]

This setting is for the User Box, network scan, fax, and network fax operations. For details, refer to the [User's Guide Network Scan/Fax/Network Fax Operations] and [User's Guide Box Operations].

7.4 [User Authentication/Account Track]

Configure the authentication settings to control the use of this machine.

Type and functions of authentication

- User Authentication
 - Appropriate for controlling users. To allow unregistered users to use this machine, public user settings are required.
 - Restricts accessible functions.
 - Counts the number of outputting and scanning by user.
 - Limits on using color or black printing and on the number of copies that can be set by user.
 - Operates a Personal User Box for each user and group box.
 - Controls the access allowed level of the destination.
 - Prohibits jobs of other users from being deleted.
- Account Track
 - Appropriate for controlling groups or multiple users.
 - Counts the number of outputting and scanning by account.
 - Limits on using color or black printing and on the number of copies that can be set by account.
 - Operates the group box.

Reference

- Either user authentication or account track settings can be configured, or user authentication can be synchronized with account track. Settings can be configured for the both and used without being synchronized.
- A total of 1000 users and accounts can be registered.
- To register more than 1000, use **Authentication Manager**. You can register up to 30000 users and accounts.



7.4.1 [General Settings]

Configure the settings for enabling the authentication functions.

- ✓ Before registering a user, select an authentication method. If all management data is cleared after the authentication method was selected, the histories of the registered users, print, send, receive, and save jobs are deleted.
- ➔ Press the **Utility/Counter** key ➔ [Administrator Settings] ➔ [User Authentication/Account Track] ➔ [General Settings].



Settings

[User Authentication]	Configure whether to use user authentication.	
	[OFF]	Disables user authentication.
	[ON (External Server)]	Restricts users who can access this machine using the external authentication server. This setting is available when external authentication server settings are configured.
	[ON (MFP)]	Restricts users who can access this machine using this machine.
[Public User Access]	Allows public user accesses when the enhanced security mode is disabled.	
	[Restrict]	Prohibits unregistered users from using this machine.
	[ON (With Login)]	A public user can use this machine after pressing [Public User Access] in the Login screen to log in to this machine.
	[ON (Without Login)]	A public user can use this machine without logging in to this machine in the Login screen.
[Account Track]	[OFF]/[ON]	Configure whether to use the account track function.
[Account Track Input Method]	Select an authentication method when configuring account track settings.	
	[Account Name & Password]	Enter the account name and password to log in.
	[Password Only]	Enter only the password to log in. <ul style="list-style-type: none"> You cannot configure this when user authentication settings are configured.
[Synchronize User Authentication & Account Track]	Configure the authentication operation settings when both user authentication and account track settings are configured. Configure whether to automatically select the account assigned to the user during logging in.	
	[Synchronize]	Allows the user to log in to one account assigned to the user. The user who succeeded in user authentication can log in without account track authentication.  Reference <i>This function is appropriate for managing each user by account.</i>
	[Do Not Synchronize]	Allows the user to log in to some accounts. The user who succeeded in user authentication performs account track authentication to log in.  Reference <i>This function is appropriate when each user performs multiple duties and counting is performed by duty.</i>
[When # of Jobs Reach Maximum]	Configure the action of this machine that is taken when the output count of the job reaches the limit specified for the user or account.	
	[Skip Job]	Stops the running job, and then automatically starts the next job.
	[Stop Job]	Stops all jobs.
[Number of User Counters Assigned]	Configure how many of a total of 1000 users and account registrations should be allowed for user registration at maximum. The remaining registration number is for accounts. When user authentication and account track settings are configured, the number of counters assigned for users can be specified.	
[Ticket Hold Time Setting]	Enter a time to hold the Kerberos authentication tickets. This item is available when the external server authentication settings are configured and [Server Type] is set to [Active Directory].	

Factory default

[User Authentication]	[OFF]
[Public User Access]	[Restrict]
[Account Track]	[OFF]
[Account Track Input Method]	[Account Name & Password]
[Synchronize User Authentication & Account Track]	[Synchronize]
[When # of Jobs Reach Maximum]	[Skip Job]
[Number of User Counters Assigned]	500
[Ticket Hold Time Setting]	60 min.

**Reference**

To configure external server settings:

*Press the **Utility/Counter** key ►► [Administrator Settings] ►► [User Authentication/Account Track] ►► [External Server Settings].*

For details on enhanced security settings, contact your service representative.

7.4.2 [User Authentication Settings]

Configure the user and user counter management settings.

- ✓ When only user authentication settings are configured, User Authentication Setting are enabled.
 - ✓ If only user authentication settings are configured, up to 1000 users can be registered. If user authentication and account track settings are configured, up to 500 users can be registered as initial settings.
- Press the **Utility/Counter** key ►► [Administrator Settings] ►► [User Authentication/Account Track] ►► [User Authentication Settings].

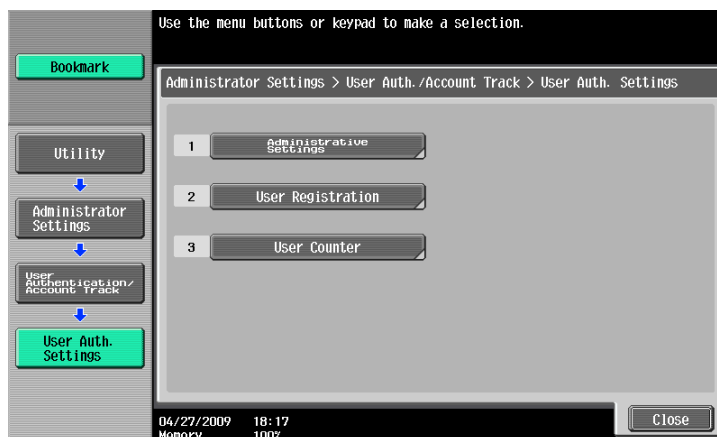

Settings

[Administrative Settings]	[User Name List]	Configure whether to display a key to display a list of registered users in the Login screen. This item is enabled when the enhanced security settings are disabled.
	[Default Function Permission]	Configure an initial value for function permission to users who are authenticated on the external server.
	[ID & Print Settings]	Configure whether to use the ID & print function. Also configure whether to immediately print unauthenticated jobs or public user job or save it in the ID & Print User Box.
	[ID & Print Operation Settings]	Configure whether to print all jobs using one authentication or print jobs one by one if multiple ID & print jobs are accumulated.
	[Default Operation Selection]	In the Login screen for user authentication where ID and print jobs are stored, specify the default values for the operation to be carried out after authentication has been completed. When using this machine while the ID & print function is disabled, the user can select [Access] to log in to this machine without specifying the operation to be carried out after authentication.

Settings

[User Registration]	<p>Register users who can access this machine. Select a desired registration number, and then press [Edit]. Settings for registered users can be changed.</p> <ul style="list-style-type: none"> • Selecting a user and pressing [Delete] delete the selected user. • If public user access is allowed, functions available to public users can be restricted.
[User Name]	<p>Enter a user name.</p> <ul style="list-style-type: none"> • Once a user name is registered, it cannot be changed. • A user name that has already been registered cannot be used again.
[Password]	<p>Enter the password.</p>
[E-Mail Address]	<p>Enter an E-mail address.</p>
[Account Name]	<p>Specify the account track of the registered user when account track settings are configured, Before you select an account name, you must registered it.</p>
[Output Permission]	<p>Apply the following restrictions to the selected user or all users.</p> <ul style="list-style-type: none"> • [Print] Configure whether to allow the user to copy and print in color and black, respectively. If black copy or print is restricted, print in black and white cannot be output. • [Send] Configure whether to allow the user to send fax and E-mail in color. <p style="text-align: right;"> Reference <i>Single color and 2 color output settings can be changed by the administrator. For details, refer to page 7-38.</i></p>
[Max. Allowance Set]	<p>Configure the max. allowance for the selected user or all users. When not specifying it, select [No Limit].</p> <ul style="list-style-type: none"> • [Total Allowance] Specify the number of copies that can be output by the user. • [Individual Allowance] Specify the number of black copies and color copies that can be output by the user.
[Register Auth. Info.]	<p>Press [Edit], and then register authentication information.</p> <p>This setting is available when the optional authentication unit is installed.</p>
[Function Permission]	<p>Restrict functions available to the selected user or all users. Specify whether to allow the following functions:</p> <ul style="list-style-type: none"> • [Copy] • [Scan] • [Fax] • [Print] • [User Box] • [Print Scan/Fax TX] • [Save to External Memory] • [External Memory Document Scan] • [Manual Destination Input] (If [Allow] is selected, specify either to allow Manual Destination Input or manage the destination manually.) • [Limited Color Print] (Public user only) • [Biometric/IC Card Info. Registration] • [Cellular Phone/PDA]

Settings

[User Registration]	[Pause]	Suspends the use of this machine for the selected user. [Stop Job] is selected, the specified user cannot log in to this machine. It is convenient to set suspend for users who do not use this machine temporarily or who have lost an IC card, instead of deleting them. <ul style="list-style-type: none"> • If [All Users] is selected, you can suspend the use of this machine for all the registered users. • If suspend is selected for a specific account, it is also suspended for users who belong to that account even if [Continue Job] is selected for this setting.
	[Icon]	Select an icon.
[User Counter]	[Reset All Counters]	Resets all counters for all users.
	[Counter Details]	Shows the use status for the selected user. Press [Clear Counter] to reset the counter. <ul style="list-style-type: none"> • The public user counter is specified for the last page.

Factory default

[User Name List]	[OFF]
[Default Function Permission]	[Save to External Memory]/[External Memory Document Scan]: [Restrict] Other items: [Allow]
[ID & Print Settings]	[ID & Print]: [OFF] (when the authentication unit is not installed) [ON] (when the authentication unit is installed) [Public User]: [Print Immediately]
[ID & Print Operation Settings]	[Print All Jobs]
[Default Operation Selection]	[Begin Printing]
[Output Permission]	All Items: [Allow]
[Max. Allowance Set]	[Individual Allowance]: [No Limit] ([Color]) or [No Limit] ([Black]) [Total Allowance]: [No Limit]
[Function Permission]	[Copy]: [Allow] [Scan]: [Allow] [Fax]: [Allow] [Print]: [Allow] [User Box]: [Allow] [Print Scan/Fax TX]: [Allow] [Save to External Memory]: [Restrict] [External Memory Document Scan]: [Restrict] [Manual Destination Input]: [Allow]/[Allow All] [Limited Color Print]: [Restrict] [Biometric/IC Card Info. Registration]: [Restrict] [Cellular Phone/PDA]: [Allow]
[Pause]	[Continue Job]
[Icon]	

**Reference**

To specify the maximum number of registrations for the user:

Press the **Utility/Counter** key ►► [Administrator Settings] ►► [User Authentication/Account Track] ►► [General Settings] ►► [Number of User Counters Assigned].

7.4.3 [Account Track Settings]

Configure the account and account counter management settings.

- ✓ When only account track settings are configured, Account Track Settings is enabled.
- ✓ If only account track settings are configured, up to 1000 accounts can be registered. If user authentication and account track settings are configured, up to 500 accounts can be registered as initial settings.

→ Press the **Utility/Counter** key ►► [Administrator Settings] ►► [User Authentication/Account Track] ►► [Account Track Settings].

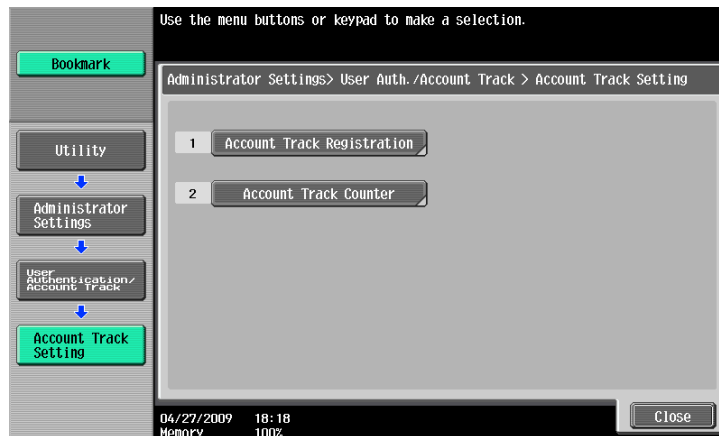

Settings

[Account Track Registration]

- Select a desired registration number, press [Edit], and then register or change the account.
- Select an account to be deleted, and the press [Delete].

[Account Name]

Specify the account name.

- An account name that has already been registered cannot be used again.

[Password]

Enter the password.

[Output Permission]

Apply the following restrictions to the selected account or all accounts.

- [Print]
Specify whether to allow color or black copy or print output to the user of the account. If black copy or print is restricted, print in black and white cannot be output.
- [Send]
Specify whether to allow the account members to send fax or E-mail in color.



Reference

Single color and 2 color output settings can be changed by the administrator. For details, refer to page 7-38.

[Max. Allowance Set]

Configure the max. allowance for the selected account or all accounts. When not specifying it, select [No Limit].

- [Total] Allowance
Configure the number of copies that can be output by a member of the account.
- [Individual Allowance]
Configure the number of black copies and color copies that can be output by a member of the account.

Settings

[Account Track Registration]	[Pause]	Suspends the use of this machine for the selected account. If [Stop Job] is selected, the specified user cannot log in to this machine. It is convenient to set suspend for accounts that do not use this machine temporarily, instead of deleting them. <ul style="list-style-type: none"> • If [All Accounts] is selected, you can suspend the use of this machine for all registered accounts. • If [Stop Job] is selected, it is also suspended for users who belong to the accounts.
[Account Track Counter]	[Reset All Counters]	Resets all counters for all accounts.
	[Counter Details]	Shows the use status for the selected account. Press [Clear Counter] to reset the counter.

Factory default

[Output Permission]	All Items: [Allow]
[Max. Allowance Set]	[Individual Allowance]: [No Limit] ([Color]) or [No Limit] ([Black]) [Total Allowance]: [No Limit]

**Reference**

To specify the maximum number of registrations for the account:

Press the **Utility/Counter** key ►► [Administrator Settings] ►► [User Authentication/Account Track] ►► [General Settings] ►► [Number of User Counters Assigned].

7.4.4 [Print without Authentication]

This setting is for the print operations. For details, refer to the [User's Guide Print Operations].

7.4.5 [Print Counter List]

Select the paper tray and print format to be used for printing the counter list.

✓ This function is enabled when user authentication or account track settings are configured.

➔ Press the **Utility/Counter** key ➔ [Administrator Settings] ➔ [User Authentication/Account Track] ➔ [Print Counter List].

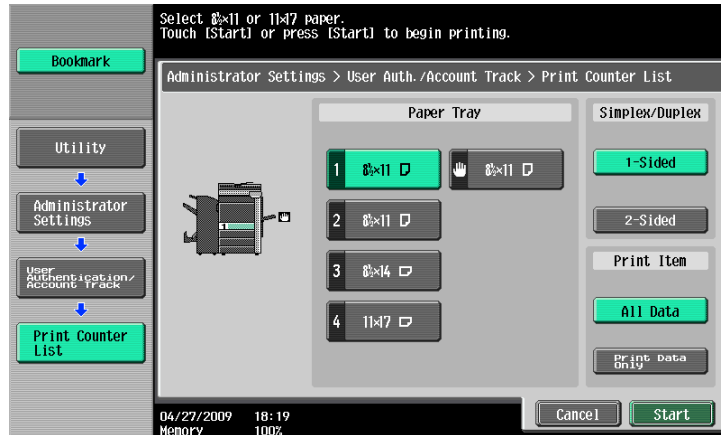

Settings

[Paper Tray]	Select the desired paper tray.
[Simplex/Duplex]	Select Print (1-Sided) or Print (2-Sided).
[Print Item]	Configure whether to print all data or printing data only.

Factory default

[Print Counter List]	<ul style="list-style-type: none"> • [Paper Tray]: Tray 1 • [Simplex/Duplex]: [1-Sided] • [Print Item]: [All Data]
----------------------	---

7.4.6 [External Server Settings]

Configure the external server that performs user authentication.

- Press the **Utility/Counter** key ► [Administrator Settings] ► [User Authentication/Account Track] ► [External Server Settings].

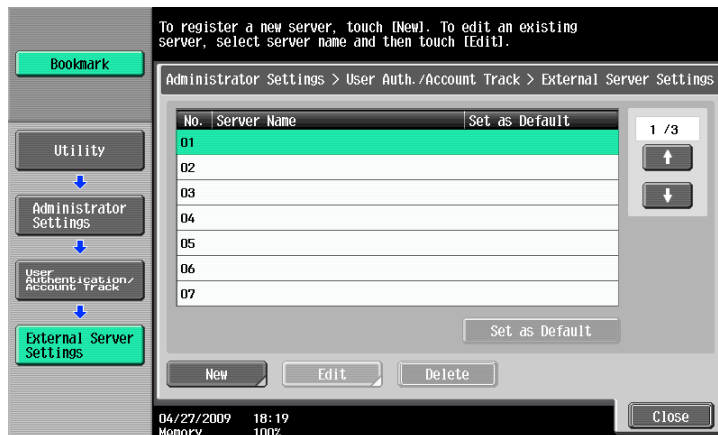

Settings

Select a number for the desired external server. You can also change the settings for the registered servers.

[New]/[Edit]	[Server Name]	Enter the name of the external server.
	[Server Type]	Configure an external server type, and then configure the settings for required items.
[Delete]	Delete the selected external server.	
[Set as Default]	Configure an external server specified as the initial value. Select a desired server, and then press the [Set as Default] button.	



Reference

For details on configuring external server settings, refer to the [User's Guide Network Administrator].

7.4.7 [Limiting Access to Destinations]

This setting is for the network scan, fax, and network fax operations. For details, refer to the [User's Guide Network Scan/Fax/Network Fax Operations] and [User's Guide Network Administrator].

7.4.8 [Authentication Device Settings]

Configure the authentication operations when the optional authentication unit is installed.

✓ This setting is available when the optional authentication unit is installed.

→ Press the **Utility/Counter** key ►► [Administrator Settings] ►► [User Authentication/Account Track] ►► [Authentication Device Settings].

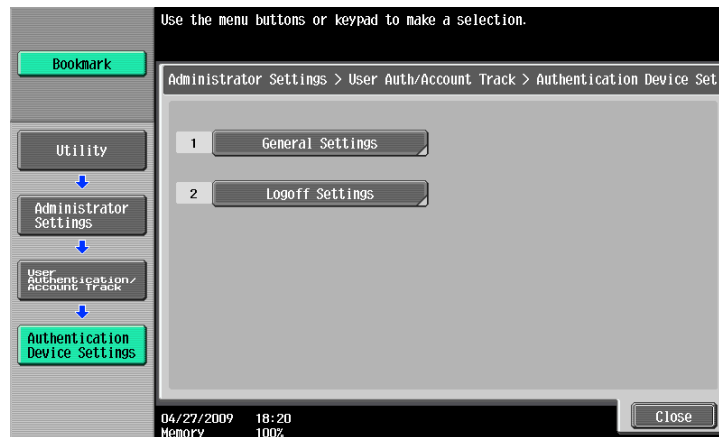

Settings

[General Settings]	[Card Authentication]	<p>Displayed when the Authentication Unit (IC card type) AU-201 is installed.</p> <ul style="list-style-type: none"> • [IC Card Type] Select the type of the IC card to be used in this machine. The FeliCa card ([FeliCa], [SSFC], [FCF], or [FCF (Campus)]) or Type A card ([Type A]) can be selected. If [FeliCa+Type A], [SSFC+Type A], [FCF+Type A], or [FCF (Campus)+Type A] is selected, both the FeliCa and Type A cards can be used in this machine at the same time. If [SSFC] or [SSFC+Type A] is selected, specify [Company Code] or [Company Identification Code]. • [Operation Settings] Specify how to log in to this machine. [IC Card Authentication] allows the user to log in by simply placing the IC card. [Card Authentication + Password] allows the user to log in by placing the IC card and entering the password.
	[Bio Authentication]	<p>Displayed when Authentication Unit (biometric type) AU-101 or Authentication Unit (biometric type) AU-102 is installed.</p> <ul style="list-style-type: none"> • [Beep Sound] Specify whether to output a beep when reading the finger vein pattern. • [Operation Settings] Specify how to log in to this machine. [1-to-many authentication] allows the user to log in by simply placing his or her finger on the authentication unit. [1-to-1 authentication] allows the user to log in by entering the user name and placing his or her finger on the authentication unit.
[Logoff Settings]	Configure whether to log out when scanning of the original finishes.	

7.4.9 [User/Account Common Setting]

Configure the settings for the logout confirmation screen and settings for single color and 2 color output management if authentication settings have been configured.

✓ This function is enabled if authentication function settings have been configured.

➔ Press the **Utility/Counter** key ➤ [Administrator Settings] ➤ [User Authentication/Account Track] ➤ [User/Account Common Setting].

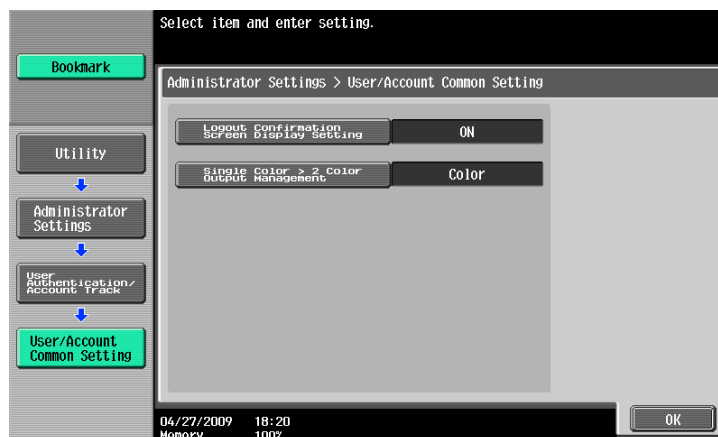

Settings

[Logout Confirmation Screen Display Setting]	Configure whether to display the logout confirmation screen when you press the Access key to log out.
[Single Color > 2 Color Output Management]	Configure whether to manage the output of single color or 2 color as color print or black print. When managing it as black print, even a user who is restricted from performing color print can perform single color or 2 color output.

 **Reference**
For details on output permission for users, refer to page 7-30 or page 7-33.

Factory default

[Logout Confirmation Screen Display Setting]	[ON]
[Single Color > 2 Color Output Management]	[Color]

7.4.10 [Scan to Home Settings]

This setting is for the network scan operations. For details, refer to the [User's Guide Network Scan/Fax/Network Fax Operations] and [User's Guide Network Administrator].

7.4.11 [Scan to Authorized Folder Settings]

This setting is for the network scan, fax, and network fax operations. For details, refer to the [User's Guide Network Scan/Fax/Network Fax Operations] and [User's Guide Network Administrator].

7.5 [Network Settings]

This setting is for the network operations. For details, refer to the [User's Guide Network Administrator].

7.6 [Copier Settings]

Configure the settings used by the copy functions.

→ Press the **Utility/Counter** key ►► [Administrator Settings] ►► [Copier Settings].

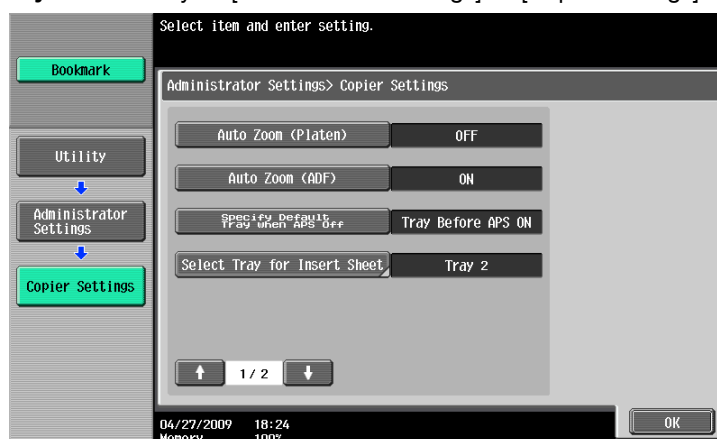

Settings

[Auto Zoom (Platen)]	Configure whether Auto Select is automatically selected when a paper tray is selected manually while an original is placed on the Original Glass .	
[Auto Zoom (ADF)]	Configure whether Auto Select is automatically selected when a paper tray is selected manually while an original is placed in the ADF .	
[Specify Default Tray when APS Off]	Configure which paper tray to be selected when the APS (Auto Paper) setting is canceled.	
	[Tray Before APS ON]	Uses the paper tray specified before the APS was selected.
	[Default Tray]	Uses Tray 1 .
[Select Tray for Insert Sheet]	Configure the default paper tray loaded with paper for the cover pages (front cover), inserted sheets and the chapter title pages.	
[Print Jobs During Copy Operation]	Configure whether to accept print data or fax data while a copy operation is being performed.	
	[Accept]	Accepts print data or fax data to print.
	[Receive Only]	Prints print data or fax data after the copy operation is finished.
[Automatic Image Rotation]	When the original orientation is different from paper orientation, the image is rotated depending on the setting. Configure when the image is automatically rotated.	
[Card Shot Settings]	Register card copy setting. If [Card Shot] is selected in [Application], the function can be invoked with the registered setting.	
	[Layout]	Specify where to place the front and back sides of a card.
	[Zoom]	Specify to copy a card with the full size or enlarge an image to fit paper.
	[Store Original Size]	Change and register the pre-specified original size or [Original Name].

Factory default

[Auto Zoom (Platen)]	[OFF]
[Auto Zoom (ADF)]	[ON]
[Specify Default Tray when APS Off]	[Tray Before APS ON]

Factory default

[Select Tray for Insert Sheet]	[Tray 2]
[Print Jobs During Copy Operation]	[Accept]
[Automatic Image Rotation]	[When Auto Paper/Auto Zoom is set]
[Card Shot Settings]	- [Layout]: [Top/Bottom] - [Zoom]: [Full Size]

7.7 [Printer Settings]

This setting is for the print operations. For details, refer to the [User's Guide Print Operations].

7.8 [Fax Settings]

This setting is for the fax and network fax operations. For details, refer to the [User's Guide Network Scan/Fax/Network Fax Operations].

7.9 [System Connection]

Configure settings for software, cellular phone, or PDA that can be accessed with this machine.

→ Press **Utility/Counter**▶▶[Administrator Settings]▶▶[System Connection].

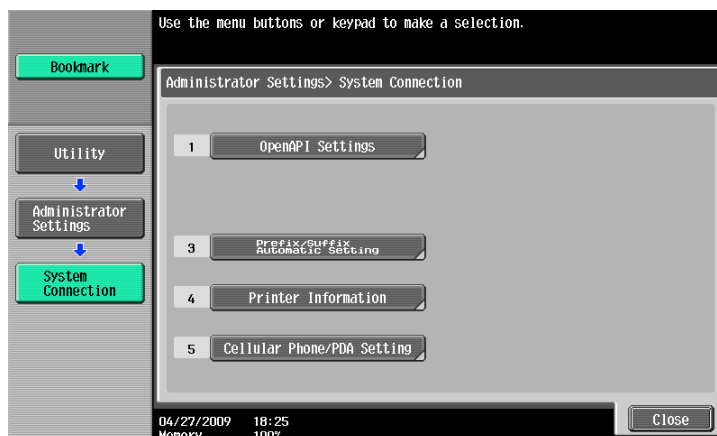

Settings

[OpenAPI Settings]	[Access Setting]	Specify whether to allow the user to access this machine from other system that is using OpenAPI.	
	[SSL/Port Settings]	[SSL Setting]	To use SSL encryption, select [SSL Only] or [SSL/Non-SSL]. <ul style="list-style-type: none"> If [Enhanced Security Mode] is enabled, [SSL Only] is enabled.
		[Port No.]	Enter a port number.
		[Port Number (SSL)]	Enter the port number to be used for SSL communication.
		[Client Certificate]	Specify whether to request for client certificates. If you authenticate the client by requesting for its certificate (verification of client certificate), select [Enable].
[Certificate Verification Level Settings]	To verify a certificate, configure settings to verify the certificate. [Expiration Date]: Select whether to check that the target certificate is within the validity period. [Key Usage]: Select whether to check that the certificate key is being used properly. [Chain]: Select whether to check that the certificate chain (certification path) is correct. [Expiration Date Confirmation]: Select whether to check the target certificate for validation. [CN] Select whether to check that the CN of the certificate matches the server address.		
[Authentication]	Specify whether to authenticate an access from other system that is using OpenAPI. <ul style="list-style-type: none"> To authenticate, enter the login name and password in [Login Name] and [Password]. When user authentication is performed or when acquiring the device information with the Authentication Manager, set the Authentication setting of the OpenAPI Setting screen of the machine to [OFF]. 		

Settings

[Prefix/Suffix Automatic Setting]	Select whether to automatically add prefix and suffix to a destination number. If [Prefix/Suffix Automatic Setting] is set to [ON], the other settings will be restricted. For details, refer to the [User's Guide Network Administrator].
[Printer Information]	Specify [Printer Name], [Printer Location], [Printer Information], and [Print URI]. The [Printer Information] setting is linked to [Printer Information] in [HTTP Server Settings].
[Cellular Phone/PDA Setting]	Specify whether to allow the user to print data in a cellular phone or PDA or save such data in a User Box.

Factory default

[Access Setting]	[Allow]
[SSL Setting]	[Non-SSL Only]
[Request Client Certificate]	[Invalid]
[Expiration Date]	[Confirm]
[Key Usage]	[Do Not Confirm]
[Chain]	[Do Not Confirm]
[Expiration Date Confirmation]	[Do Not Confirm]
[CN]	[Do Not Confirm]
[Authentication]	[OFF]
[Prefix/Suffix Automatic Setting]	[OFF]
[Cellular Phone/PDA Setting]	[Restrict]

7.10 [Security Settings]

Configure the settings for the restricting the functions of this machine for processing secret data.

7.10.1 [Administrator Password]

Change the administrator password.

- ✓ The administrator password can be entered using 0 through 8 digits.
- ✓ If password rules are specified, an 8-digit password must be entered.
- ✓ If you enter an incorrect administrator password a configured number of times, you are prohibited from using this machine. In this case, contact your service representative.

- 1 Press the **Utility/Counter** key ► [Administrator Settings] ► [Security Settings] ► [Administrator Password].



Factory default

[Administrator Password]	12345678
--------------------------	----------

- 2 Enter the administrator password, and then press [OK].
- 3 Enter a new administrator password.
- 4 Press [Password Confirmation], and enter the administrator password again.
- 5 Press [OK].
The password is changed.



Reference

To configure password rule settings:

Press the **Utility/Counter** key ► [Administrator Settings] ► [Security Settings] ► [Security Details] ► [Password Rules].

7.10.2 [User Box Administrator Setting]

Configure settings for the User Box operations. For details, refer to the [User's Guide Box Operations].

7.10.3 [Administrator Security Levels]

Configure settings so that the user can change some of the settings accessible only to the administrator. Settings allowed to the user appear in User Settings.

→ Press **Utility/Counter**▶▶[Administrator Settings]▶▶[Security Settings]▶▶[Administrator Security Levels].



Settings

[Level 1]	<p>Allows the user to change the following settings.</p> <ul style="list-style-type: none"> • [Power Save Settings] • [Auto Zoom (Platen)] • [Auto Zoom (ADF)] • [Specify Default Tray when APS Off] • [Select Tray for Insert Sheet] • [Automatic Image Rotation] • [Card Shot Settings]
[Level 2]	<p>Allows the user to change the following settings.</p> <ul style="list-style-type: none"> • All settings allowed in Level 1 • [Output Settings] • [AE Level Adjustment] • [Blank Page Print Settings] • [Change E-Mail Address] • [Print Jobs During Copy Operation]
[Prohibit]	<p>Does not allow the user to change the settings allowed in Level 1 and Level 2.</p>

Factory default

[Administrator Security Levels]	[Prohibit]
---------------------------------	------------

7.10.4 [Security Details]

Configure security detail settings to restrict the functions of this machine. You can restrict the functions to enhance security.

→ Press the **Utility/Counter** key ► [Administrator Settings] ► [Security Settings] ► [Security Details].



Settings

[Password Rules]

Configure whether to enable the password rules. When enabled, the restrictions are applied to the following passwords. The set passwords must be changed to ones that meet the conditions.

- Administrator Password
- User password
- Account password
- User Box password
- Security document password
- Encryption password
- WebDAV server password
- SNMP password (auth-password/priv-password)

<Conditions of the password rules>

- Specify a password in 8 or more digits.
- Uppercase and lowercase letters are differentiated.
- Only half-width symbols can be used. For some of the passwords, specification of "", "+", and "space" is restricted.
- A password that consists of a repetition of the same character cannot be specified.
- The same password as one before being changed cannot be registered.

Settings

[Prohibited Functions When Authentication Error]	<p>Configure restrictions on the authentication operation to prevent invalid accesses, such as an access attempt using an incorrect password. Possible restrictions include disabling authentication operations and locking access to the machine for a specified period of time.</p> <p>Prohibited Functions When Authentication Error is applicable to the following passwords.</p> <ul style="list-style-type: none"> • User password • Account password • User Box password • Security document password • Administrator Password • Encryption password • WebDAV server password • SNMP password (auth-password/priv-password)
[Mode 1]	Disables authentication operations for a specified time if authentication fails.
[Mode 2]	<p>Disables authentication operations for a specified period of time if authentication fails. Specify the maximum allowance for authentication operation frequency. The number of failed attempts is tracked, and when the maximum value is reached, the authentication operation is blocked and access to the machine is denied.</p> <p>The setting cannot be changed from [Mode 2] when the enhanced security mode is turned on. The maximum number of attempts allowed is 3.</p>
[Release]	Releases the prohibited operations due to failure in authentication, enabling the authentication operations.
[Release Time Settings]	<p>Configure the length of time after an invalid access attempt has been detected using the Administrator Settings and the machine has been locked for the machine to become enabled again. The time period to re-enable operations is based on the time this machine starts.</p> <p>To cancel the access lock to Administrator Settings, the main power switch must be turned off and on.</p>
[Confidential Document Access Method]	<p>Synchronizes with the settings for [Prohibited Functions When Authentication Error], automatically changes it.</p> <ul style="list-style-type: none"> • [Mode 1] Requires entering security document ID and password before selecting a security document from a User Box. • [Mode 2] Performs authentication based on the password after you enter the security document ID and select a security document from a User Box.
[Manual Destination Input]	This setting is for the network scan, fax, and network fax operations. For details, refer to the [User's Guide Network Scan/Fax/Network Fax Operations].
[Print Data Capture]	This setting is for the print operations. For details, refer to the [User's Guide Print Operations].
[Job Log Settings]	Configure job log settings to be obtained when power is turned off and on. Specify the type of obtain log and whether to permit overwriting. Pressing [Erase Job Log] erases the job log.
[Restrict Fax TX]	This setting is for the fax and network fax operations. For details, refer to the [User's Guide Network Scan/Fax/Network Fax Operations].
[Hide Personal Information]	
[Hide Personal Information (MIB)]	Specify whether to display the file name, address, or User Box number as MIB information in Job List.
[Display Activity Log]	This setting is for the fax and network fax operations. For details, refer to the [User's Guide Network Scan/Fax/Network Fax Operations].
[Initialize]	Initializes Job History, Network Settings, Copy Program, or Store Address.

Settings

[Job History Thumbnail Display]	Configure whether to perform thumbnail display when displaying the job history.
[Secure Print Only]	This setting is for the print operations. For details, refer to the [User's Guide Print Operations].
[Copy Guard]	Specify whether to use the copy guard function. <ul style="list-style-type: none"> If [Copy Guard] is selected in [Application], you can embed copy inhibit information on paper. You can also detect copy inhibit information embedded on paper. This item is displayed when the optional Security Kit SC-507 is installed.
[Password Copy]	Specify whether to use the password copy function. <ul style="list-style-type: none"> If [Password Copy] is selected in [Application], you can embed a password on paper. You can also detect a password embedded on paper. This item is displayed when the optional Security Kit SC-507 is installed.

Factory default

[Password Rules]	[Invalid]
[Prohibited Functions When Authentication Error]	<ul style="list-style-type: none"> [Prohibit Functions When Auth. Error]: [Mode 1] [operation Ban release time]: 5 min.
[Confidential Document Access Method]	[Mode 1]
[Manual Destination Input]	[Allow All]
[Print Data Capture]	[Allow]
[Job Log Settings]	[No]
[Restrict Fax TX]	[OFF]
[Hide Personal Information]	[OFF]
[Hide Personal Information (MIB)]	[ON]
[Display Activity Log]	[ON]
[Job History Thumbnail Display]	[OFF]
[Secure Print Only]	[No]
[Copy Guard]	[No]
[Password Copy]	[No]

7.10.5 [Enhanced Security Mode]

The enhanced security mode cannot be enabled when any of the current functional settings conflict with the enhanced security mode.

When the enhanced security mode is enabled, the settings required for the mode or the settings that have been forcibly switched when entering the mode cannot be changed.

Required settings

To enable the enhanced security mode, the following settings must have been configured.

Administrator Settings	Required settings
[User Authentication/Account Track] / [General Settings] / [User Authentication]	Select either [ON (External Server)] or [ON (MFP)]. <ul style="list-style-type: none"> When you enable account track, select [Account Name & Password] for the account track input method.
[Security Settings] / [Administrator Password]	Set a password complying with password rules.
[Security Settings] / [HDD Settings] / [HDD Encryption Setting]	Specify a HDD encryption passphrase.
[Security]/[PKI Settings]/[SSL Setting] in Web Connection	<ul style="list-style-type: none"> Set [Mode using SSL/TLS] to [Admin. Mode] and [User Mode]. Set [Encryption Strength] to [AES-256] or [3DES-168].
<ul style="list-style-type: none"> [Image Controller Setting] [Management Function Choice] [CE Password] [CE Authentication] [HDD] All the settings above must be configured by your service representative.	These items must be configured by your service representative. For details, contact your service representative.

Settings to forcibly changed

When the enhanced security is enabled, the following settings are forced.

- The changed settings will not revert when the enhanced security mode is turned off.
- After the password rules have been changed, any passwords that do not comply with the changed rules will not be authenticated. For details on the password rules, refer to page 7-48.
- For details on the network settings to be forcibly changed, refer to the [User's Guide Network Scan/Fax/Network Fax Operations].

Administrator Settings	Settings to forcibly changed
[System Settings] / [Restrict User Access] / [Restrict Access to Job Settings] / [Registering and Changing Addresses]	Set to [Restrict].
[User Authentication/Account Track] / [General Settings] / [Public User Access]	Set to [Restrict].
[User Authentication/Account Track] / [User Authentication Settings] / [Administrative Settings] / [User Name List]	Set to [OFF].
[User Authentication/Account Track] / [Print without Authentication]	Set to [Restrict].
[Network Settings] / [FTP Settings] / [FTP Server Settings]	[FTP Server Settings] is not displayed.
[Network Settings] / [SNMP Settings] / [SNMP v1/v2c Settings]	[Write Setting] is set to [Invalid].
[Network Settings] / [SNMP Settings] / [SNMP v3 Settings]	In [Write User], [Security Level] cannot be set to [OFF].
[Network Settings] / [TCP Socket Settings]	[Use SSL/TLS] is set to [ON].
[Network Settings] / [WebDAV Settings] / [WebDAV Server Settings] / [SSL Setting]	Set to [SSL Only].
[System Connection] / [OpenAPI Settings]	Set to [SSL Only].
[Security Settings] / [User Box Administrator Setting]	Set to [Restrict].
[Security Settings] / [Security Details] / [Password Rules]	Set to [Enable].
[Security Settings] / [Security Details] / [Prohibited Functions When Authentication Error]	Set to [Mode 2], and the number of tries is set to 3. <ul style="list-style-type: none"> • The number of tries can be changed to 1, 2, or 3.
[Security Settings] / [Security Details] / [Prohibited Functions When Authentication Error] / [Release Time Settings]	The allowable setting range is limited to 5 or more minutes. This value cannot be less than 5 minutes.
[Security Settings] / [Security Details] / [Confidential Document Access Method]	Set to [Mode 2].
[Security Settings] / [Security Details] / [Print Data Capture]	Set to [Restrict].
[Security Settings]/[Security Details]/ [Hide Personal Information (MIB)]	Set to [ON].
[Security Settings] / [Security Details] / [Initialize] / [Network Settings]	[Network Settings] is not displayed.
[Security Settings]/[Security Details]/ [Job History Thumbnail Display]	Set to [OFF].
[Security Settings] / [Image Log Transfer Settings]	Set to [OFF].
Review [Secure Document User Box]	Only the list is displayed before the password authentication is performed.
[Network] in Web Connection / [E-mail Setting] / [S/MIME]	[Automatically Obtain Certificates] is set to [OFF]. [E-Mail Text Encrypt. Method] is set to [3DES].

Administrator Settings	Settings to forcibly changed
[Maintenance] in Web Connection / [Reset] / [Network Setting Clear]	[Network Setting Clear] is not displayed.
[Security]/[Administrator Password Setting] in Web Connection	[Administrator Password Setting] is not displayed.
CS Remote Care	Restricts the device setting in the remote mode based on CS Remote Care.

If Enhanced Security settings is enabled, various security functions are configured to allow you to ensure higher-level security of data management. For details, contact your service representative. To enable the enhanced security mode, the following settings must first be configured. Different screens appear depending on the current settings.

7.10.6 [HDD Settings]

This setting is for the hard disk operations. For details, refer to the [User's Guide Box Operations].

7.10.7 [Function Management Settings]

Configure whether to use network functions that are difficult to count.

- Press **Utility/Counter**▶▶[Administrator Settings]▶▶[Security Settings]▶▶[Function Management Settings].

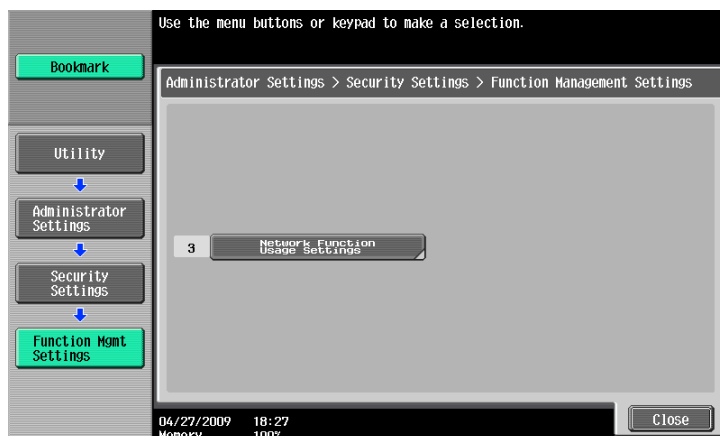

Settings

[Network Function Usage Settings]	[ON]	Configure the settings for the network management that are difficult to count.
	[OFF]	<p>The following functions cannot be used if [Network Function Usage Settings] is set to [OFF].</p> <ul style="list-style-type: none"> • PC-FAX transmission • Using the HDD TWAIN driver to view and retrieve documents in User Boxes • Using Box Operator to view and retrieve documents in User Boxes • Using Scan Direct to retrieve documents in User Boxes • Box operations using Web Connection (The User Box tab does not appear.)

Factory default

[Network Function Usage Settings]	[ON]
-----------------------------------	------

7.10.8 [Stamp Settings]

Manage the stamp.

→ Press the **Utility/Counter** key ►► [Administrator Settings] ►► [Security Settings] ►► [Stamp Settings].

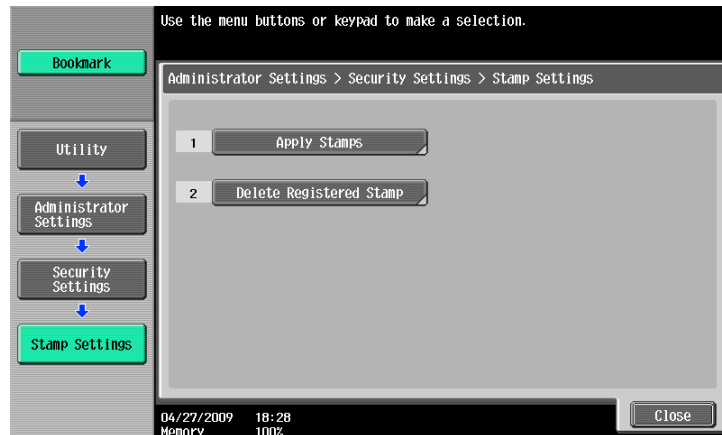

Settings

[Stamp Settings]	[Apply Stamps]	Configure whether to add a stamp when printing or sending. To add a stamp, configure stamp contents settings.
	[Delete Registered Stamp]	<ul style="list-style-type: none"> • [Stamp] Deletes all registered stamps. • [Copy Protect/Stamp Repeat] Deletes all stamps registered in Copy Protect and the stamp repeat function.



Reference

If a stamp is added, print settings cannot be configured in [Stamp/Composition] of [Application].

Factory default

[Apply Stamps]	[Printing]: [Do Not Apply] [Sending]: [Do Not Apply]
----------------	---



Reference

To configure copy protect and stamp repeat settings:

Press [Application] ►► [Stamp/Composition].

7.10.9 [Driver Password Encryption Setting]

This setting is for the print operations. For details, refer to the [User's Guide Print Operations].

7.11 [License Settings]

Enables the optional functions of **i-Option LK-101**, **i-Option LK-102**, or **i-Option LK-105**. For details on the enabling procedure, refer to the [Quick Guide Copy/Print/Fax/Scan/Box Operations].

- ✓ You must purchase optional **i-Option LK-101**, **i-Option LK-102**, or **i-Option LK-105**. For details, contact your service representative.

→ Press **Utility/Counter**▶▶[Administrator Settings]▶▶[License Settings].

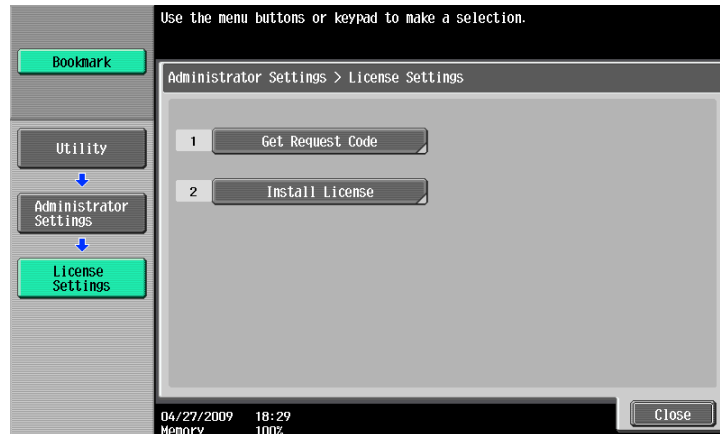

Settings

[Get Request Code]	Issue a request code for this machine to be registered in the license management server (LMS).
[Install License]	Enter the function code and license code obtained from the license management server (LMS).

Reference

- You can confirm the enabled functions in [List of Enabled Functions] when the optional **i-Option LK-101**, **i-Option LK-102**, or **i-Option LK-105** function is enabled.

7.12 [OpenAPI Authentication Management Setting]

Configure settings to prevent our deprecated OpenAPI connection application from being registered in this machine.

For details, contact your service representative.

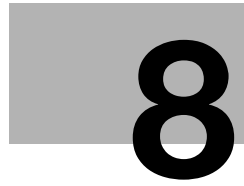

Maintenance

8 Maintenance

8.1 Paper

8.1.1 Checking the paper

Replenishment message

If a tray has run out of paper during printing, the message [Replenish paper or select another paper tray.] appears. Load paper in the paper tray that is highlighted in color.

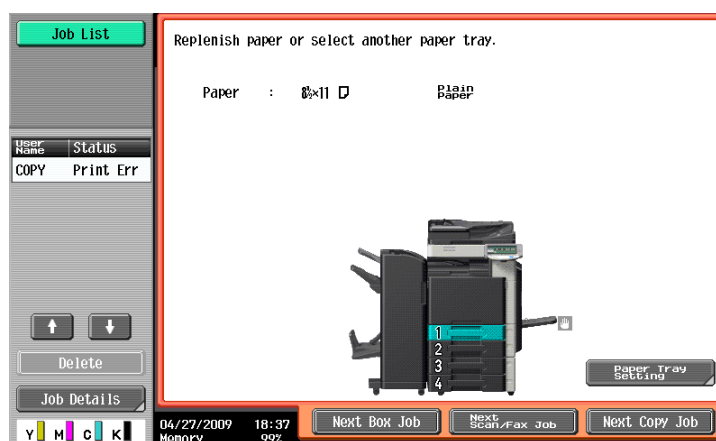

Precautions regarding the use of paper

Do not use the following types of paper. Not observing these precautions may lead to reduced print quality, a paper jam or a damage to the machine.

- OHP transparencies that have already been fed through the machine (even if they are still blank)
- Paper that has been printed on with a heat-transfer printer or an inkjet printer
- Folded, curled, wrinkled, or torn paper
- Paper that has been left unwrapped for a long period of time
- Damp paper, perforated paper, or paper with punched holes
- Extremely smooth or extremely rough paper, or paper with an uneven surface
- Paper that has been treated, such as carbon-backed, heat-sensitive or pressure-sensitive paper
- Paper that has been decorated with foil or embossing
- Paper of a non-standard shape (paper that is not rectangular)
- Paper that is bound with glue, staples or paper clips
- Paper with labels attached
- Paper with ribbons, hooks, buttons, etc., attached

Paper storage

Store paper in a cool, dark location with little humidity. If the paper becomes damp, a paper jam may occur. Store the paper flat, not on its edge. Curled paper may cause a paper jam.

8.1.2 Loading paper

This section describes how to load paper into each tray.

If printing stops due to the tray being empty, load paper into the tray. Printing restarts automatically.

For the types of paper to be used, refer to page 12-3.

Loading paper in Tray 1, Tray 2, Tray 3, or Tray 4

The procedure for loading paper is common between **Tray 1**, **Tray 2**, **Tray 3**, and **Tray 4**.

The following procedure describes how to load paper into **Tray 1**.

- ✓ **Tray 3** and **Tray 4** are optional.
- ✓ When [Auto Detect] is selected on the [Paper] tab, the size of loaded paper is automatically detected.

1 Pull out **Tray 1**.

→ 1. Film

NOTICE

*Be careful not to touch the **Film**.*

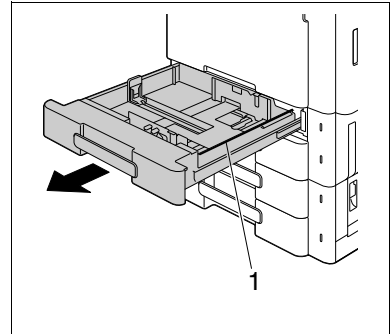

2 Slide the **Lateral Guide** to fit the size of paper being loaded.

→ If the **Lateral Guide** are not positioned correctly for the loaded paper, the paper size will not be correctly detected.

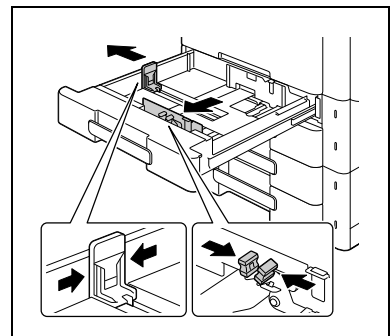

3 Load the paper into the tray so that the side of the paper to be printed on (the side facing up when the package was unwrapped) faces up.

- Do not load so many sheets of paper that the top of the stack is higher than the ▼ mark.
- If paper is curled, flatten it before loading it.
- If special paper is loaded, the paper type must be specified.
- Load letterhead paper so that the side to be printed on faces down.

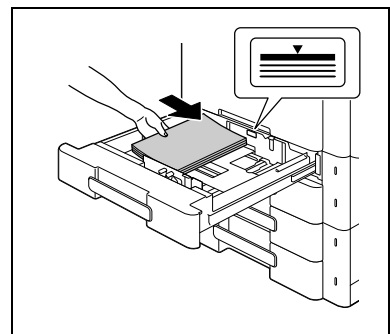

4 Close **Tray 1**.



Reference

To configure paper settings:

Press [Basic] ►► [Paper].

Loading paper in LCT

The following procedure describes how to load paper in **LCT**.

- ✓ **LCT** is an option.
- ✓ You cannot pull out the **LCT** tray when the **Sub Power Switch** is turned off. You cannot also pull out the **LCT** tray in the Low Power or Sleep mode.

1 Press **Tray Release Button**.

- This unlocks the **LCT** tray and slides the LCT tray slightly forward.

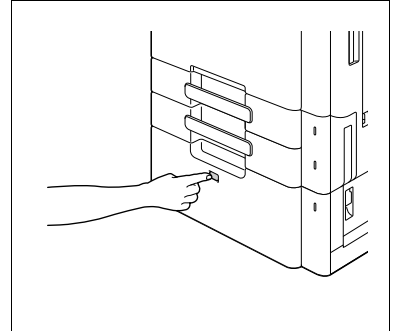

2 Pull out the **LCT** tray.

- 1. **Film**

NOTICE

*Be careful not to touch the **Film**.*

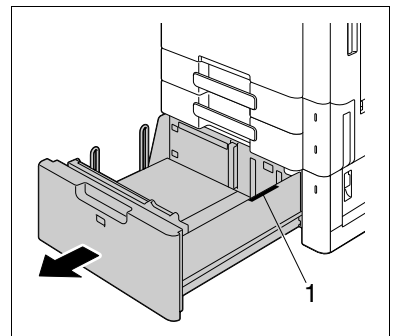

3 Load paper into the right side of the **LCT** tray so that the side to be printed (the side facing up when the package was unwrapped) faces up.

- Do not load so many sheets of paper that the top of the stack is higher than the ▼ mark.
- Do not load the **LCT** tray with paper of a size other than that previously specified.
- If paper is curled, the paper type must be specified.
- If special paper is loaded, the paper type must be specified.
- Load letterhead paper so that the side to be printed on faces down.

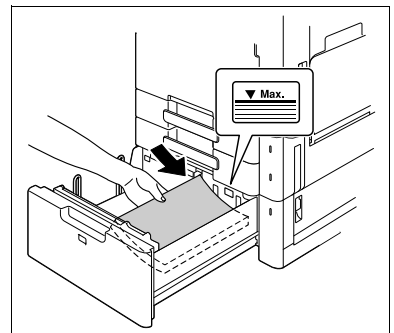

4 Load paper into the left side of the **LCT** tray so that the side to be printed (the side facing up when the package was unwrapped) faces up.

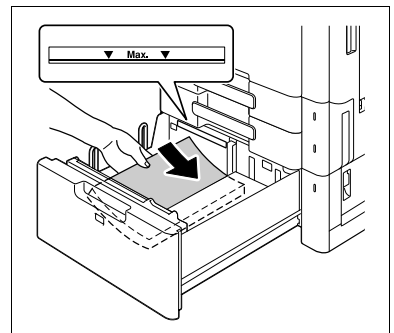

- 5 Close the **LCT** tray.



Reference

To configure paper settings:

Press [Basic] ►► [Paper].

Loading paper into the Bypass Tray

- 1 Open the **Bypass Tray**.

→ To load large-sized paper, pull out the tray extension.

NOTICE

Be careful not to touch the surface of the **Paper Take-Up Roller** with your hand.

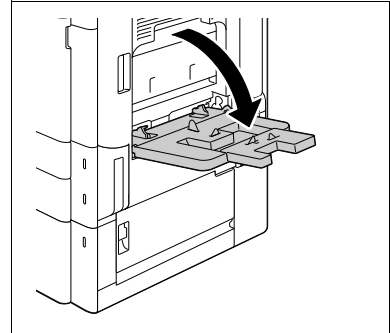

- 2 With the side to be printed on facing down, insert the paper as far as possible into the feed slot.

- The image will be printed on the surface of the paper facing down when the paper is loaded into the bypass tray.
- Do not load so many sheets of paper that the top of the stack is higher than the mark.
- If paper is curled, flatten it before loading it.
- Push the **Lateral Guide** firmly up against the edges of the paper.
- Load letterhead paper so that the side to be printed on faces up.

- When loading postcards:

Load them in the  orientation, as shown in the illustration. To use postcards other than the 4 × 6 (A6) size, check the size of postcards to be used, and then specify the size on the Custom Size screen before using them.

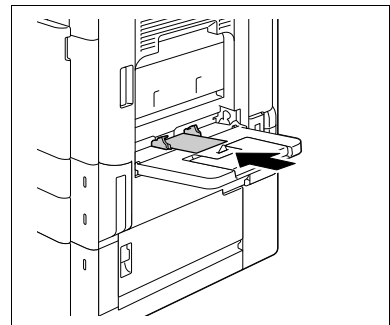

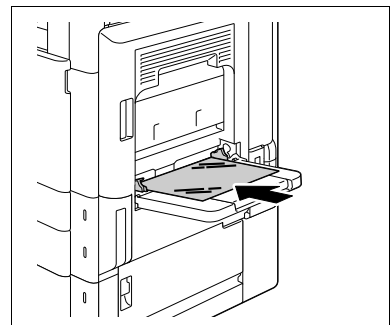

- When loading Transparency:

Load them in the  orientation, as shown in the illustration.

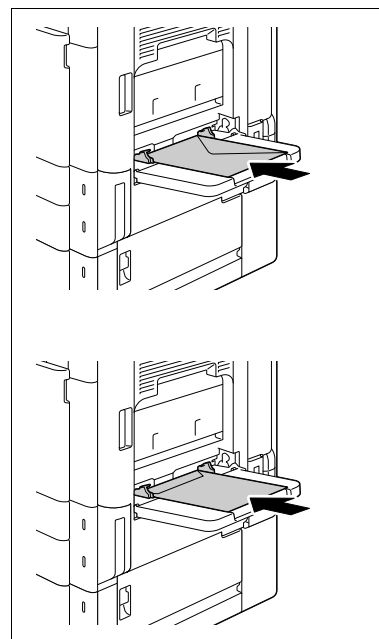

- When using envelopes:
Expel air from the envelopes, and then load them while holding the folds of the envelopes.
Load them with the flap side up, as shown in the illustration.
The flap side of envelopes cannot be printed on.



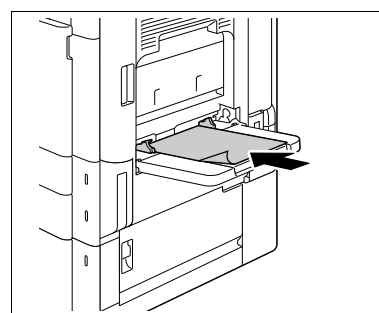

- To load label sheets:
Load them in the  orientation, as shown in the illustration.
A label sheet consists of the printing surface, sticking layer, and pasteboard. Peel off the pasteboard, then you can stick the label to other objects.

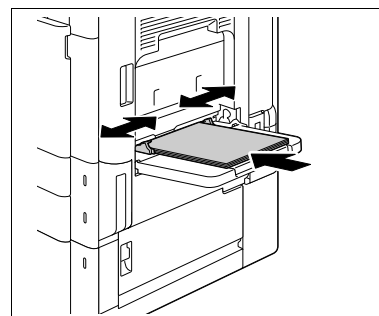

- 3** Slide the **Lateral Guide** to fit the size of paper being loaded.



- 4** Select the paper type.
- To use label sheets, select [Thick 1].
 - OHP transparencies can be printed only in black. Before selecting OHP transparencies, select [Black] in the Color tab.
 - If you select [4 × 6 ] ([A6 Card ]), the paper type is automatically set to [Thick 3].



Reference

To configure paper settings:

Press [Basic] ►► [Paper].

8.2 Consumables

8.2.1 Checking consumables

Replacement message

When it is time to replace the **Toner Cartridge** or **Drum Unit**, an advanced warning message appears at the top of the screen.

For the replacement procedure, refer to the guidance or the [Quick Guide Copy/Print/Fax/Scan/Box Operations].

For details on using the guidance, refer to the [Quick Guide Copy/Print/Fax/Scan/Box Operations].

When the message appears, make a preparation and replace the **Toner Cartridge** or **Drum Unit** according to the guidance contained in your maintenance agreement.

When it is almost time to replace the **Toner Cartridge**, an advanced warning message similar to the one shown below appears.

When the message appears, prepare to replace the **Toner Cartridge** according to the guidance contained in your maintenance agreement.

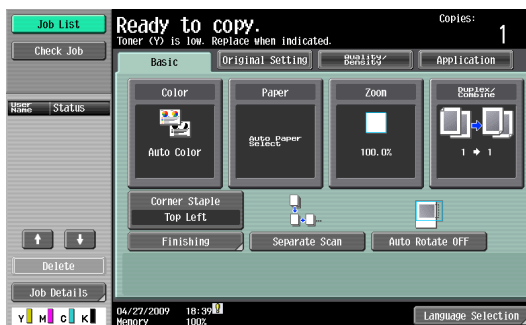

When it is time to replace the **Toner Cartridge** or **Drum Unit**, an advanced warning message similar to the one shown below appears. Replace them according to the guidance contained in your maintenance agreement.

- Do not replace any color other than the one indicated in the message in the touch panel.
- For the **Toner Cartridge**, the machine stops operating after the message appears.

Toner Cartridge

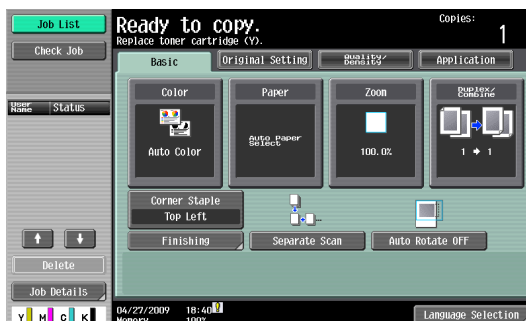

Drum Unit

Replacement by user

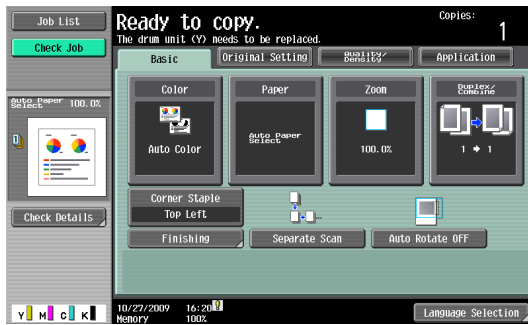

Replacement by service representative

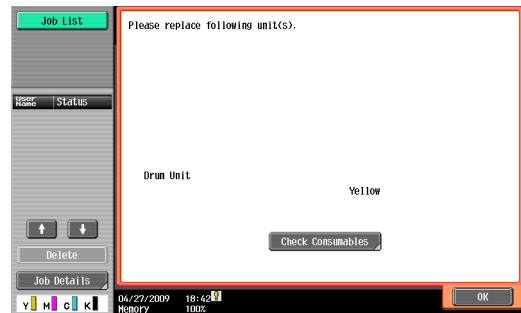

NOTICE

Do not replace the **Drum Unit** until a [Please replace following unit(s).] message appears.

If you continue to use the drum unit while an advanced warning message is displayed, the following replacement message appears. Replace the drum unit according to the guidance contained in your maintenance agreement.

Toner Cartridge



Drum Unit

Replacement by user

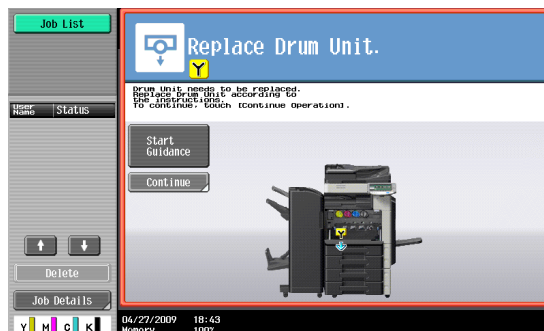

Replacement by service representative

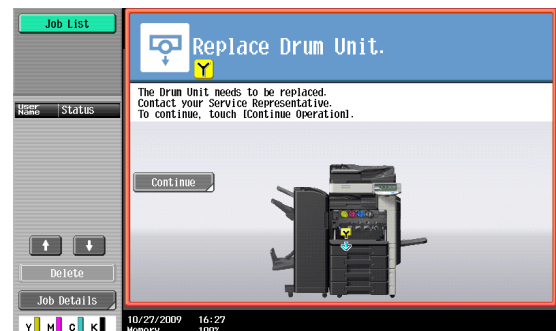

If a **Toner Cartridge** other than for black or the **Drum Unit** is empty, printing can continue using black. Press [Continue], and then select the job to be printed.

Checking consumables status

In the Check Consumable Life screen, you can check the status (usage level) of consumables.

- 1 Press the **Utility/Counter** key.
- 2 Press [Check Consumable Life].
 - To print the list of usage levels, press [Print List], then [Start] or the **Start** key.



Viewing counters

On the Meter Count screen, you can check the total number of prints since counting started. In the Coverage Rate screen, the consumed amount of toner can be viewed. For a breakdown of the sales counter data, refer to the following table.

- 1 Press the **Utility/Counter** key.
- 2 Press [Meter Count] ►► [Check Details].
 - To print the counter list, press [Print List], select paper, and then press the **Start** key.

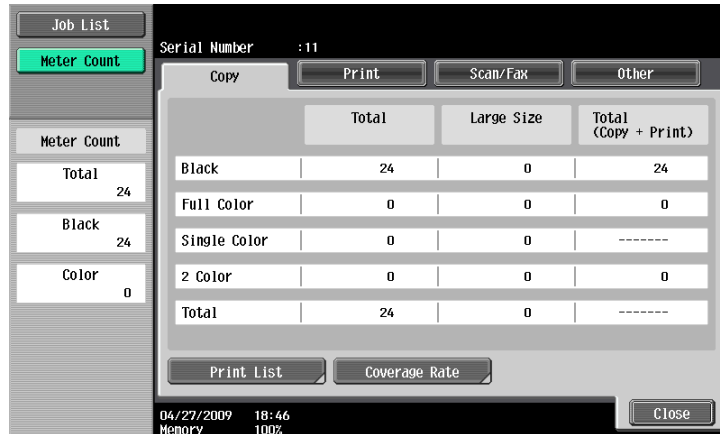

- To display the Coverage Rate screen, press [Coverage Rate].



<Meter Count>

Item	Description
Total	The cumulative total number of pages printed
Black	The total number of pages printed in black
Color	The total number of pages printed in color

<Copy>

	Total	Large Size	Total (Copy + Print)
Black	The total number of pages printed in black in Copy mode and from the data saved in a user box using Copy mode, and the number of list pages printed in Utility/Administrator mode	The total number of pages printed in black in Copy mode and from the data saved in a user box using Copy mode on large-sized paper, and the number of list pages printed in Utility/Administrator mode	The total number of black copies and black PC prints
Full Color	The total number of pages printed in full color in Copy mode and from the data saved in a user box using Copy mode	The total number of pages printed in full color in Copy mode and from the data saved in a user box using Copy mode on large-size paper	The total number of full color copies and full color PC prints
Single Color	The total number of pages printed in a single color in Copy mode and from the data saved in a user box using Copy mode	The total number of pages printed in a single color in Copy mode and from the data saved in a user box from the copy mode on large-sized paper	-
2 Color	The total number of pages printed in 2 colors in Copy mode and from the data saved in a user box using Copy mode	The total number of pages printed in 2 colors in Copy mode and from the data saved in a user box using Copy mode on large-sized paper	The total number of 2-color copies and 2-color PC prints
Total	The total number of pages printed in Copy mode and from the data saved in a user box using Copy mode	The total number of pages printed in Copy mode and from the data saved in a user box using Copy mode on large-sized paper	-

<Print>

	Total	Large Size	Total (Copy + Print)
Black	The total number of pages printed in black according to the print instructions received from the PC	The total number of pages printed in black on large-sized paper according to the print instructions received from the PC	The total number of black copies and black PC prints
Full Color	The total number of pages printed in full color according to the print instructions received from the PC	The total number of pages printed in full color on large-sized paper according to the print instructions received from the PC	The total number of full color copies and full color PC prints
2 Color	The total number of pages printed in 2 colors according to the print instructions received from the PC	The total number of pages printed in 2 colors on large-sized paper according to the print instructions received from the PC	The total number of 2-color copies and 2-color PC prints
Total	The total number of pages printed according to the print instructions received from the PC	The total number of pages printed on large-sized paper according to the print instructions received from the PC	-

<Scan/Fax>

	Total	Large Size
Black	The total number of pages printed in black from the images scanned by Fax/Scan mode and saved in a user box, or from received images. Images received via Memory RX are not counted unless they are printed.	The total number of large-size original pages printed in black from the images scanned by Fax/Scan mode and saved in a user box, or from received images. Images received via Memory RX are not counted unless they are printed.
Full Color	The total number of pages printed in full color from the images scanned by Fax/Scan mode and saved in a user box, or from received images. Images received via Memory RX are not counted unless they are printed.	The total number of large-size original pages printed in full color from the images scanned by Fax/Scan mode and saved in a user box, or from received images. Images received via Memory RX are not counted unless they are printed.
Scans	The total number of original pages scanned on the original glass or by ADF in the Fax/Scan screen or the User Box screen	The total number of large-size original pages scanned on the original glass or by ADF in the Fax/Scan screen or the User Box screen
Fax TX	The total number of pages sent via the G3 fax TX	-
Fax RX	The total number of pages received via the G3 fax RX	-

<Other>

Item	Description
Original Counter	The total number of original pages scanned and printed in Copy, Printer, Fax or Scanner mode <ul style="list-style-type: none"> • Even when data is saved in a user box, it is not counted unless it is printed. • Printed reports or lists are not counted.
Paper Counter	The total number of sheets printed in Copy, Printer, Fax or Scanner mode <ul style="list-style-type: none"> • Even when data is saved in a user box, it is not counted unless it is printed. • Printed reports or lists are not counted.
Total Duplex	The total number of pages printed in 2-Sided mode <ul style="list-style-type: none"> • When printed in 2-Sided mode, two pages are counted as one print.

Checking the total number of pages printed

Pressing Total Counter displays the total number of pages printed to date.

1. Total counter

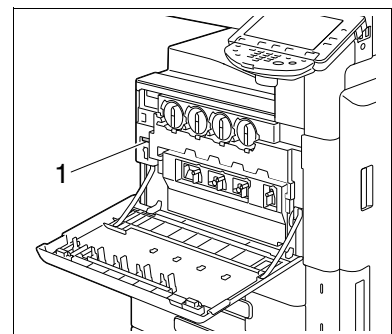

8.3 Cleaning procedure

Slit Scan Glass

- 1 Open the **ADF**, and then remove the **Slit Glass Cleaner**.

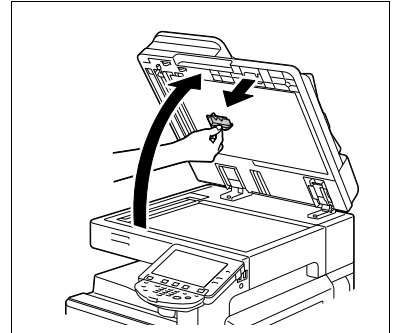

- 2 Wipe stains off the **Slit Scan Glass** using the **Slit Glass Cleaner**.
 - Wipe off stains from the back side to the front side along the guide.

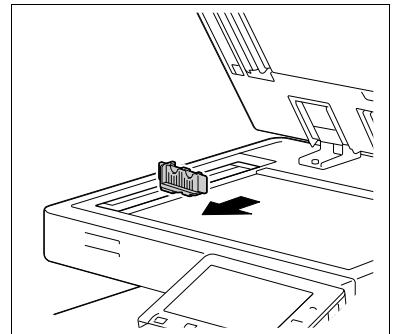

Original Glass, Control Panel, Paper Take-Up Roller

NOTICE

Do not press the **Control Panel** hard, or the keys and **Touch Panel** may be damaged.

- Wipe the surface using a soft, dry cloth.

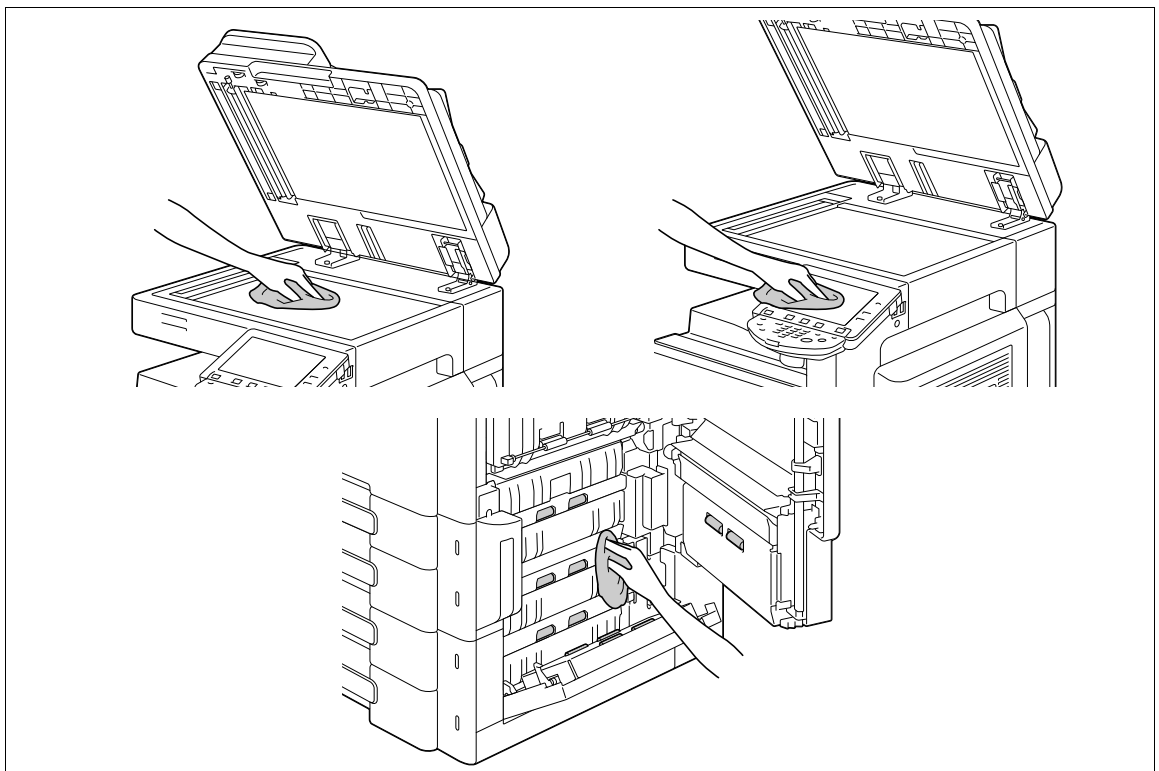

Housing, Original Pad

NOTICE

*Never use solvents, such as benzene or thinner, to clean the **Original Pad**.*

→ Wipe the surface using a soft cloth moistened with a mild household detergent.

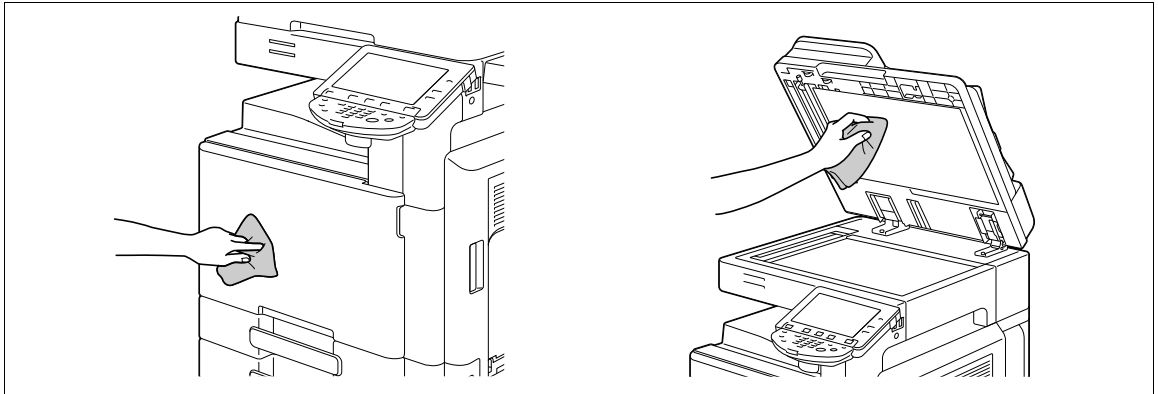

9 Troubleshooting

9 Troubleshooting

This chapter describes troubleshooting.

9.1 When a problem is detected (call a service representative)

If a problem is detected, perform the operation described in the message. If the problem is not resolved, perform the following operations, and then contact your service representative.

Normally, the phone number and fax number of your service representative appear in the center of the screen.

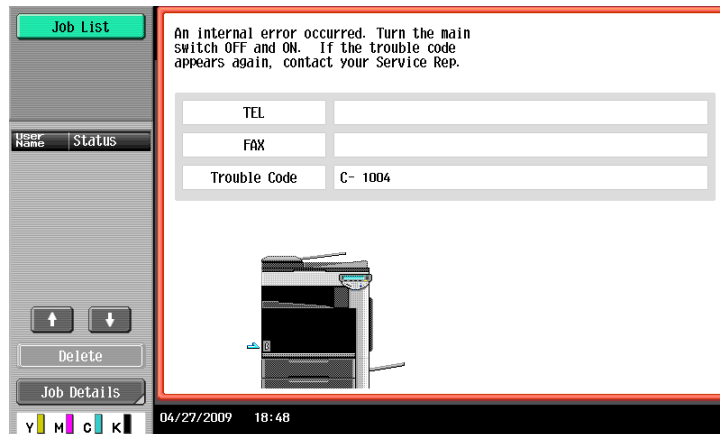

If a defective part can be separated in order to be able to continue operations after a problem has been detected, [Continue] or [Recover Data] is displayed. To continue operations, select any key. However, the problem has not been resolved, so contact your service representative immediately.

Problems that cannot be corrected by the user

- 1 Write down the malfunction code in the Service Call screen.
- 2 Turn off the **Sub Power Switch**.

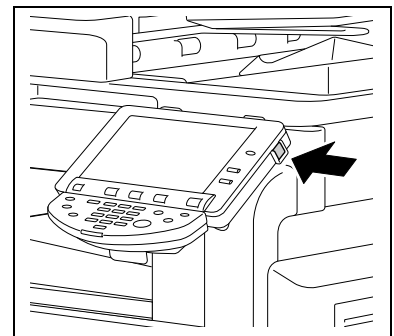

- 3 Turn off the **Main Power Switch**.

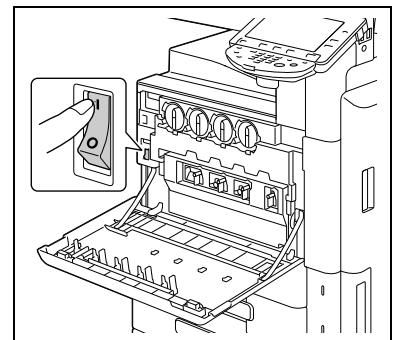

- 4 Unplug the machine.
- 5 Contact your service representative and inform them of the written down malfunction code.

9.2 Troubleshooting table

Simple troubleshooting

The following explains simple troubleshooting procedures. If the problem is not corrected after the described operation is performed, contact your service representative.

Description of problem	Check points	Remedy
The machine does not start up when the Main Power Switch is turned on	Is power being supplied from the electrical outlet?	Correctly insert the power supply plug into the electrical outlet.
	Has the Sub Power Switch been turned on?	Turn on the Sub Power Switch .
Copying does not start	Is the Top Right Door of the machine open?	Securely close the Top Right Door of the machine.
	Is there any paper that matches the original?	Load paper of the appropriate size into the paper tray.
The printed output is too light	Is the copy density set to [Light]?	Press [Dark] in the Density screen to copy at the desired copy density. (p. 5-19)
	Is the paper damp?	Replace with new paper. (p. 8-4)
The printed output is too dark	Is the copy density set to [Dark]?	Press [Light] in the Density screen to copy at the desired copy density. (p. 5-19)
	Was the original not pressed close enough against the Original Glass ?	Position the original so that it is pressed closely against the Original Glass . (p. 3-6)
The image is partially obscured or blurry.	Is the paper damp?	Replace with new paper. (p. 8-4)
	Was the original not pressed close enough against the Original Glass ?	Position the original so that it is pressed closely against the Original Glass . (p. 3-6)
There are dark specks or spots throughout the printed output There are streaks in the printed output	Is the Original Glass dirty?	Wipe the Original Glass with a soft, dry cloth. (p. 8-14)
	Is the Slit Scan Glass dirty?	Clean the Slit Scan Glass with the Slit Glass Cleaner. (p. 8-14)
	Is the Original Pad dirty?	Clean the Original Pad with a soft cloth dampened with a mild detergent. (p. 8-15)
	Was the original printed on highly translucent material, such as diazo photosensitive paper or OHP transparencies?	Place a blank sheet of paper on top of the original. (p. 3-6)
	Is a 2-sided original being copied?	If a thin 2-sided original is being copied, the print on the back side may be reproduced on the front side of the copy. In the Background Removal screen, select a lighter background density. (p. 5-19)
	Is the Electrostatic Charger Wire dirty?	Use the Charger Cleaner to clean the Electrostatic Charger Wire . (p. 9-13)

Description of problem	Check points	Remedy
The image is printed at an angle	Is the original positioned correctly?	Correctly position the original against the Original Scale . (p. 3-6) Load the original into the ADF , and slide the adjustable Lateral Guide to fit the size of the original. (p. 3-5)
	Is the original incorrectly positioned in the ADF ?	If the original cannot be fed correctly through the ADF , make copies by positioning the original on the Original Glass . (p. 3-6)
	Is the Slit Scan Glass dirty? (while using the ADF)	Clean the Slit Scan Glass with the Slit Glass Cleaner . (p. 8-14)
	Are the adjustable Lateral Guide incorrectly positioned against the edges of the paper?	Slide the adjustable Lateral Guide against the edges of the paper.
	Was curled paper loaded into the paper tray?	Flatten the paper before loading it.
The printed page is curled	Was paper that curls easily (as with recycled paper) used?	Remove the paper from the paper tray, turn it over, and then load it again.
		Replace with new dry paper. (p. 8-4)
The edge of the printed image is dirty	Is the Original Pad dirty?	Clean the Original Pad with a soft cloth dampened with a mild detergent. (p. 8-15)
	Was the selected paper size larger than the original? (With a Zoom setting of "Full Size" (100.0%))	Select a paper size that is the same size as the original. Otherwise, select Auto to enlarge the copy to the selected paper size. (p. 5-8)
	Is the size or orientation of the original different from that of the paper? (With a Zoom setting of "Full Size" (100.0%))	Select a paper size that is the same size as the original. Otherwise, select a paper orientation that is the same as that of the original.
	Was the copy reduced to a size smaller than the paper? (with a reduced zoom ratio specified)	Select a zoom ratio that adjusts the original size to the selected paper size. Otherwise, select Auto to enlarge the copy to the selected paper size. (p. 5-8)
Even though a paper jam was cleared, copies cannot be produced	Is paper jammed at other locations?	Remove any jammed paper from other locations.
Printing with the "2-Sided > 1-Sided" or "2-Sided > 2-Sided" settings are not available	Have settings been selected that cannot be combined?	Check the combinations of the selected settings.
Copying is not possible even though the password is entered on a machine with account track settings configured	Did the message [Your account has reached its maximum allowance.] appear?	Contact your administrator.
The original is not fed	Is the ADF slightly open?	Securely close the ADF .
	Is the original one that does not meet the specifications?	Check that the original is one that can be loaded into the ADF . (p. 12-8)
	Is the original correctly loaded?	Position the original correctly. (p. 3-5)

Description of problem	Check points	Remedy
The Finisher FS-527, Finisher FS-529, or Job Separator JS-505 does not operate	Is any power being supplied to the connector?	Check that the cord is correctly inserted into the connector.
The staple is incorrectly positioned by 90°	Has the staple position been correctly specified?	Specify the desired position for stapling. (p. 5-12)
The pages that were fed out were not uniformly loaded and the punched holes or staples are incorrectly positioned	Is the paper curled?	Remove the paper from the paper tray, turn it over, and then load it again.
	Is there a gap between the Lateral Guide in the paper tray and the sides of the paper?	Slide the Lateral Guide in the paper tray against the sides of the paper so that there is no gap.
	Is the paper type configured correctly?	Configure the paper type of the selected tray correctly.
Though the authentication unit is connected with this machine using a USB cable, the status indicator LED does not light in green	A malfunction of the USB port of this machine is suspected.	Turn off the Main Power Switch of this machine, disconnect the USB cable from this machine or authentication unit, and then connect it again. Wait at least 10 seconds, and then turn on the Main Power Switch of this machine.
Though the authentication unit is connected with the computer using a USB cable, the status indicator LED does not light in green	MA malfunction of the USB port of your computer is suspected.	Restart your computer.
	Has the authentication unit driver being installed correctly?	Check that the driver is correctly installed in your computer. (p. 10-3), (p. 11-3)
No notice sound is given when scanning is started or authentication is finished on this machine	Has the notice sound being set to OFF on this machine?	Turn on the notice sound of this machine. (p. 10-3)
When the [Failed to register] message appears on this machine where registration fails	The scanning time on the authentication unit is limited per scanning. If scanning does not finish within the limited time, the corresponding message appears. For details on the scanning time, contact your service representative.	To finish scanning within the limited time, refer to [Quick Guide Copy/Print/Fax/Scan/Box Operations] to confirm how to perform authentication and how to place your finger when scanning. During scanning, place the scanned part on the scanning section correctly, and do not move it until results have been obtained. If the scanned part is dusty or rough and dry when performing authentication, a correct image will not be able to be obtained, and scanning may not finish. Clean your finger, and then scan it again, or improve the rough and dry condition of your finger. If the scanned part is too thick or thin (when the finger width is outside the range from 3/8 inch (10 mm) to 1 inch (25 mm)), a correct image will not be able to be obtained, and scanning may not finish. Try "stretching your finger", "placing your finger deeply", or "placing your finger shallowly" on the scanning section.
When the [Failed to authenticate.] message appears on this machine where registration fails		
When the [Failed to read data. Place your finger once again and the Click [Start reading] button.] message appears on this machine where registration fails		

Description of problem	Check points	Remedy
Scanning does not start	Have you placed your finger correctly on the authentication unit?	Refer to [Quick Guide Copy/Print/Fax/Scan/Box Operations] to confirm how to perform authentication and how to place your finger when scanning. During scanning, place the scanned part on the scanning section correctly, and do not move it until results have been obtained. If the scanned part is dusty or rough and dry when performing authentication, a correct image will not be able to be obtained, and scanning may not finish. Clean your finger, and then scan it again, or improve the rough and dry condition of your finger. If the scanned part is too thick or thin (when the finger width is outside the range from 3/8 inch (10 mm) to 1 inch (25 mm)), a correct image will not be able to be obtained, and scanning may not finish. Try "stretching your finger", "placing your finger deeply", or "placing your finger shallowly" on the scanning section.
	Did you restart this machine after connecting the authentication unit to this machine?	Turn off the Main Power Switch of this machine, disconnect the USB cable from this machine or authentication unit, and then connect it again. Wait at least 10 seconds, and then turn on the Main Power Switch of this machine.
When the [Failed to register.] message appears on this machine where registration fails	The scanning time of the authentication unit is limited to 10 seconds. If scanning does not finish within the limited time, the corresponding message appears.	To finish scanning within the limited time, refer to [Quick Guide Copy/Print/Fax/Scan/Box Operations] to confirm how to place the IC card.
When a message appears on the computer where registration fails		
When the [Failed to authenticate.] message appears on this machine where registration fails	When IC card authentication + password authentication is enabled Did you enter the correct password?	Check the password, and then enter the correct one if not.
Scanning does not start	Did you restart this machine after connecting the authentication unit to this machine?	Turn off the Main Power Switch of this machine, disconnect the USB cable from this machine or authentication unit, and then connect it again. Wait at least 10 seconds, and then turn on the Main Power Switch of this machine.
Connecting the authentication unit to the computer starts the hardware uninstall wizard	Is the USB port to which the authentication unit is connected the same as the one used when installing the driver?	If you connect the authentication unit to a different USB port from the one used when installing the driver, the hardware uninstall wizard may start. Use the same USB port as the one used when installing the driver.

Main messages and their remedies









If any message other than those listed below appears, perform the operation described in the message.

Message	Cause	Remedy
[Originals left on original glass.]	The original has been left on the Original Glass .	Remove the original from the Original Glass .
[Paper of matching size is not available. Select the paper size.]	Paper of a suitable size is not loaded in a paper tray.	Either select paper of a different size or load paper of a suitable size.
[Load paper in the bypass tray.]	Paper of a suitable size is not loaded in the Bypass Tray .	Load paper of the appropriate size into the Bypass Tray .
[The original size cannot be detected. Select the paper size.]	(1) The original is not positioned correctly. (2) An original with a nonstandard size or with a size too small to be detected is loaded.	(1) Position the original correctly. (2) Select the correct paper size.
[The image will not fit in the selected paper size. Position the original in a different orientation.]	The image does not fit in the paper.	Turn the original 90 and load it.
[Cannot be set with Auto Color.]	Functions that cannot be used together are selected.	Make copies using only one of the functions.
[The output tray has reached its capacity. Remove paper from the tray indicated by →.]	Copy cannot be performed because the paper loading capacity of the output tray of the displayed Finisher FS-527 , Finisher FS-529 , or Job Separator JS-505 has reached the maximum.	Remove all paper from the indicated tray.
[Enter a login user name and password, and then touch [Login] or press [Access].]	User authentication settings have been configured. Copies cannot be made unless a user name and correct password are entered.	Enter the correct user name and password. (p. 4-9)
[Enter Account Name and password, and then touch [Login] or press the [Access] key.]	Account track settings have been configured. Copies cannot be made unless an account name and correct password are entered.	Enter the correct account name and password. (p. 4-9)
[Your account has reached its maximum allowance.]	The limit on the number of pages that can be printed has been reached.	Contact the administrator of the machine.
[The part indicated by → is open. Ensure that it is properly closed.]	Since a machine door or cover is open or an option is not installed correctly, the machine is unable to make copies.	Make sure that all doors and covers of this machine and options are closed securely.
[Set Drum Unit and shut all doors.]	The indicated Drum Unit is not installed correctly.	Reinstall each consumable and replaceable part. Or contact your service representative.
[Install toner cartridge (Y).]	The indicated Toner Cartridge is not installed correctly.	Reinstall each consumable and replaceable part. Or contact your service representative.
[Set the toner cartridge, and close all doors.]	The indicated Toner Cartridge is not installed correctly.	Reinstall each consumable and replaceable part. Or contact your service representative.
[Install the waste toner box and close all doors.]	The Waste Toner Box is not installed correctly.	Reinstall each consumable and replaceable part. Or contact your service representative.
[An invalid drum unit is installed. Set the correct drum unit, and shut all doors.]	The correct Drum Unit is not set.	Reinstall each consumable and replaceable part. Or contact your service representative.

Message	Cause	Remedy
[Replenish paper.]	The indicated tray has run out of paper.	Add paper. (p. 8-4)
[Toner (Y) is low. Replace when indicated.]	The toner for the indicated color is about to run out.	Prepare a spare Toner Cartridge for replacement following the guidance contained in your maintenance agreement.
[Replace toner cartridge (Y).]	The toner is about to run out.	Replace the Toner Cartridge following the guidance contained in your maintenance agreement.
[Toner is depleted. Replace the toner cartridge following the guidance (explanation). Press the [Continue] button to continue the operations.]	Toner is depleted.	Replace the Toner Cartridge following the guidance contained in your maintenance agreement.
[No more staples. Replace the staple cartridge, or cancel stapling.]	The staples have run out.	Replace the Staple Cartridge .
[Misfeed detected. Remove paper according to the instructions.]	Since a paper jam occurred, the machine is unable to make copies.	Clear the jammed paper.
[Empty the hole-punch scrap box. To continue the job, cancel punching.]	(1) The hole-punch scrap box is full. (2) The Punch Scrap Box is not installed.	Throw punch scraps away from the Punch Scrap Box . Install the Punch Scrap Box .
[Reset the following number of originals.]	After clearing a paper jam, it is necessary to reload certain pages of the original that have already been fed through the ADF .	Load the indicated original pages into the ADF .
[An internal error occurred. Open and then close the front door to remedy a problem. If the trouble code appears again, contact your Service Rep.]	The machine malfunctioned and is unable to make copies.	Take a remedy according to the message displayed in the screen. If the problem is not resolved or released, inform your service representative of the malfunction code displayed in the screen.
[An internal error occurred. Turn the main switch OFF and ON. If the trouble code appears again, contact your Service Rep.]		
[Malfunction detected. Please call your Service Representative.]	The machine malfunctioned and is unable to make copies.	Inform your service representative of the code displayed in the screen.
[Clean the original glass on the left with the glass cleaner. Continuing using the machine in this condition may cause lines to appear in the output.]	The Slit Scan Glass is dirty.	Use the Slit Glass Cleaner to clean it.
[Now Downloading Program Data from the Firmware server.]	(1) CS Remote Care was activated by your service representative. (2) Internet ISW is being downloaded.	Do not turn off the Sub Power Switch while this message is displayed. After turning off the Sub Power Switch , turn off the Main Power Switch , and then contact your service representative.
[Authentication information entered is invalid, due to failed access attempts. Contact your administrator.]	The authentication information has become invalid since the authentication attempts have failed the specified number of times.	Contact the administrator of the machine.
[Due to failed access attempts, the current administrator password is invalid.]	The administrator password has become invalid since the authentication attempts have failed the specified number of times.	Turn the machine off, then on again. Turn off the Main Power Switch , and then wait at least 10 seconds before turning it on again.

Message	Cause	Remedy
[The job log has reached the maximum allowed. Contact the administrator.]	The write area of the job log has reached the maximum allowed.	Obtain the job log using Web Connection .
[No Animation Guide data available. Contact your administrator.]	Animation guide data is not installed.	For details on installing animation guide data, contact your service representative.
[Verify that external keyboard is properly connected. It may not be connected or multiple keyboards may be connected.]	The compact keyboard is not connected to this machine.	Turn off the main power of this machine, connect the compact keyboard to this machine. Wait at least 10 seconds, and then turn on the main power of this machine.

Icons that appear in the touch-panel screen

Icon	Description
	Indicates that data is being sent from the machine, regardless of the current mode.
	Indicates that the machine is receiving data, regardless of the current mode.
	Indicates that an error occurred during an image stabilization operation, a print operation or a scan operation. Press this icon to view a screen containing a warning code.
	If the warning screen has been closed while a warning occurs, press this button to display the warning screen again.
	Appears when there is a message indicating that consumables must be replaced or the machine requires maintenance. Press this icon to display the message, and then perform the replacement or maintenance procedure.
	Appears when an error occurs with the connection to the POP server.
	Indicates that there is no paper in the paper tray.
	Indicates that very little paper remains in the paper tray.
	Appears if the optional Image Controller IC-412 v1.1 is installed. When this icon is pressed, the Image Controller IC-412 v1.1 setting screen appears.
	Indicates that the "Enhanced Security Mode" is set to "ON".
	Appears when the external memory (USB memory) is not connected.
	Indicates that a nonstandard external memory has been connected to this machine, therefore, USB connection is not enabled.
	Indicates that the job is in the waiting-for-redial status because, for example, the recipient's line is busy when sending with the G3 Fax or IP Address Fax function.

9.3 If print quality is deteriorated

Cleaning the Electrostatic Charger Wire

If the **Electrostatic Charger Wire** is dirty, streaks will appear through the printed images. If this occurs, follow the procedure described below to clean the **Electrostatic Charger Wire**.

- 1 Open the **Front Door**.

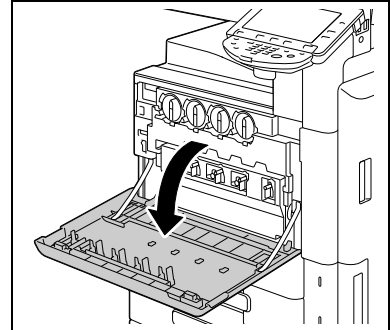

- 2 Slowly pull out the **Charger Cleaner** as far as possible. Next, slowly push in the charger-cleaning tool as far as possible. Repeat the above operations three times.

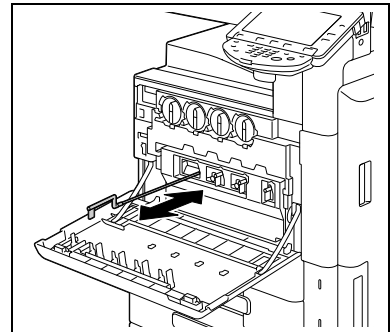

- 3 Securely insert the **Charger Cleaner**, and then close the **Front Door**.

Cleaning the Printhead

If the **Printhead** becomes dirty, print quality may be reduced. If this occurs, clean the **Printhead** according to the following procedure.

- 1 Open the **Front Door**.

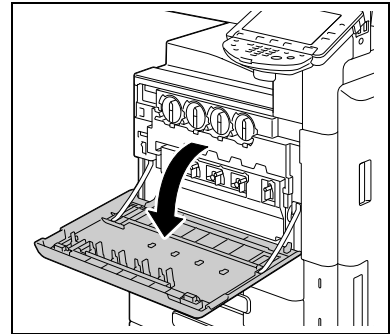

- 2 Release the **Waste Toner Box Lock Lever**, and then remove the **Waste Toner Box**.

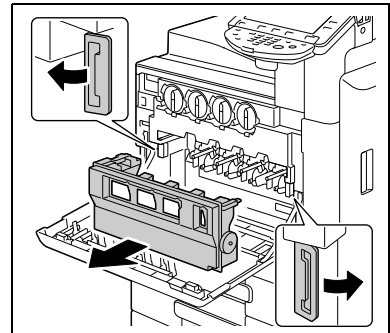

- 3 Slowly pull out the **Printhead Cleaner** toward until it stops. Next, slowly push in the charger-cleaning tool as far as possible. Repeat the above operations three times.

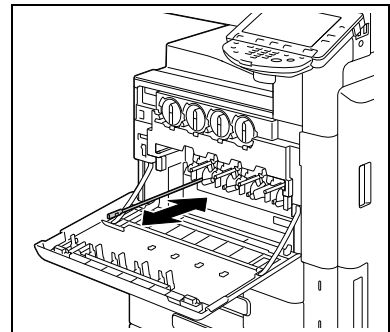

- 4 Securely insert the **Printhead Cleaner**, and install the **Waste Toner Box**.
- 5 Close the **Front Door**.

10

Authentication unit (biometric type)

10 Authentication unit (biometric type)

This chapter describes the **Authentication Unit (biometric type) AU-101** or **Authentication Unit (biometric type) AU-102**.

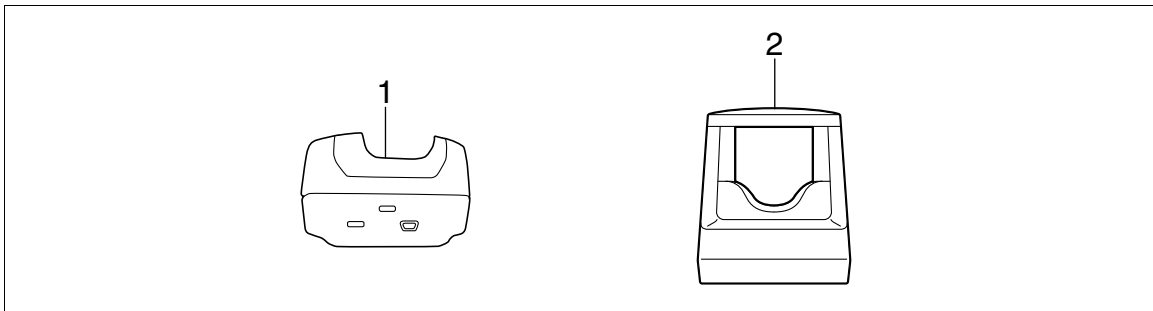

1. **Authentication Unit (biometric type) AU-101**
2. **Authentication Unit (biometric type) AU-102**

10.1 Using an authentication unit (biometric type)

The **Authentication Unit (biometric type) AU-101** or **Authentication Unit (biometric type) AU-102** is a "biometrics (biometric authentication)" system that scans finger vein patterns to perform personal authentication. Using the biometric authentication, you can log in to this machine where user authentication settings are configured in order to execute a print job.

Place your forefinger straight so that your forefinger cushion slightly touches the hollow and protuberance part of the scanning section. Secure your middle finger and thumb on the both sides of the authentication unit to prevent your forefinger to be used for authentication from rotating.

For details on how to place your forefinger on the authentication unit, refer to page 10-19.

NOTICE

*If the **Authentication Unit (biometric type) AU-101** is changed to the **Authentication Unit (biometric type) AU-102**, the users registered in the **Authentication Unit (biometric type) AU-101** cannot be used in the **Authentication Unit (biometric type) AU-102**. Connect the **Authentication Unit (biometric type) AU-102** to this machine, and then register users again.*

Do not place anything other than your finger on the scanning section during scanning operation. Doing so may cause a malfunction.

Do not disconnect the USB cable from the authentication unit or computer during a scanning operation. Doing so may cause the system to become unstable.

The status indicator LED and notice sound indicate the status of the authentication unit.

Status indicator LEDs	Status
Lit in green	Ready state or authentication is completed
Flash in green	During authentication or scanning operation
Lit in red	Authentication failed or scanning failed
Unlit	The authentication unit is not recognized

Notice sound	Status
One short blip sound	Scanning starts
One short blip sound	During a retry after authentication failed
One short blip sound ^{*1} /two short blip sounds ^{*2}	Authentication completed
Two short blip sounds ^{*1} / one short blip and one long beep sounds ^{*2}	Authentication failed
One long beep sound ^{*2}	Scanning canceled

1 Authentication Unit (biometric type) AU-101**2 Authentication Unit (biometric type) AU-102**

To use the **Authentication Unit (biometric type) AU-101** or **Authentication Unit (biometric type) AU-102**, first register the finger vein pattern of the user in this machine. The registered user, who is authenticated with the finger vein pattern, can log in to this machine or execute a print job. This section explains how to configure the required settings in this machine, register users, and log in with authentication.

10.1.1 Configuring this machine

NOTICE

User authentication settings must be configured with MFP authentication on this machine.

This device does not support external server authentication. To combine account track settings with user authentication settings, set Synchronize User Authentication & Account Track to [Synchronize].

- 1 Use the **Control Panel** of this machine to display the Administrator Settings screen. Press [User Authentication/Account Track], then [General Settings].
- 2 Set [User Authentication] to [ON (MFP)], and then press [OK].

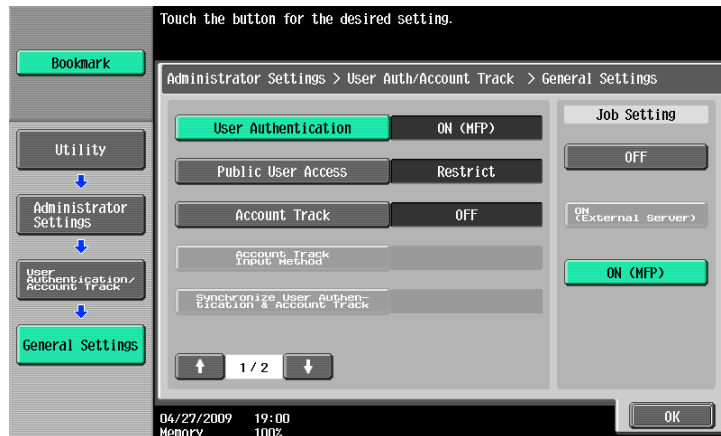

- 3 Press [Yes], and then [OK].



- 4 Press [Authentication Device Settings].
- 5 Press [General Settings].
- 6 Press [Bio Authentication].

7 Configure [Beep Sound] and [Operation Settings].



→ For [Beep Sound], specify whether to give a "blip" sound when the finger vein pattern is scanned successfully.

→ For [Operation Settings], specify how to log in to this machine after registration.

[1-to-many authentication]: Allows the user to log in by simply placing his or her finger.

[1-to-1 authentication]: Allows the user to log in by entering the user name and placing his or her finger.

For details on how to log in to this machine, refer to page 10-19.

8 Press [OK] twice.

9 Press [Logoff Settings].

10 Specify whether to log out the user when scanning the original has finished after the user logged in with the authentication unit.

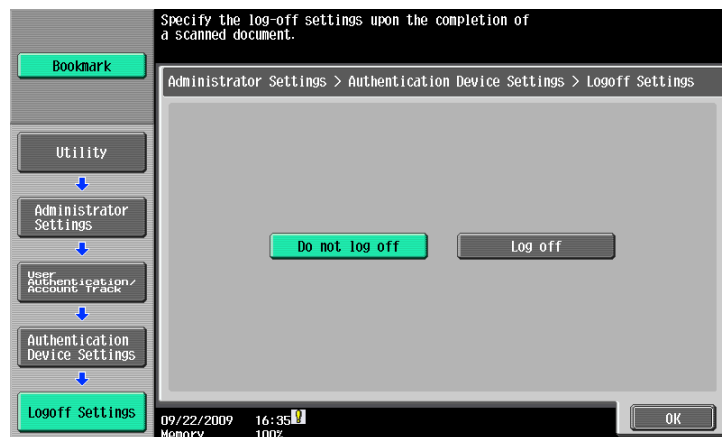

11 Press [OK].

12 Press [Close] twice.

10.1.2 Registering a user

The following two methods can be used to register a user.

- Connect the authentication unit to this machine, and directly register the target user in this machine
- Connect the authentication unit to your computer, and use **Data Administrator** to register the target user

NOTICE

The registered user data is saved in the HDD of this machine. Changing the user authentication type of this machine or formatting the HDD will erase the registered user data.

Registering a user using the Control Panel of this machine

- 1 Use the **Control Panel** of this machine to display the Administrator Settings screen. Press [User Authentication/Account Track], and then [User Authentication Settings].

NOTICE

[User Authentication Settings] is disabled when User Authentication is set to [OFF] in General Settings.

- 2 Press [User Registration].
- 3 Select a desired registration number, and then press [Edit].



- 4 Press [Register Auth. Info.].



- 5 Press [Edit].

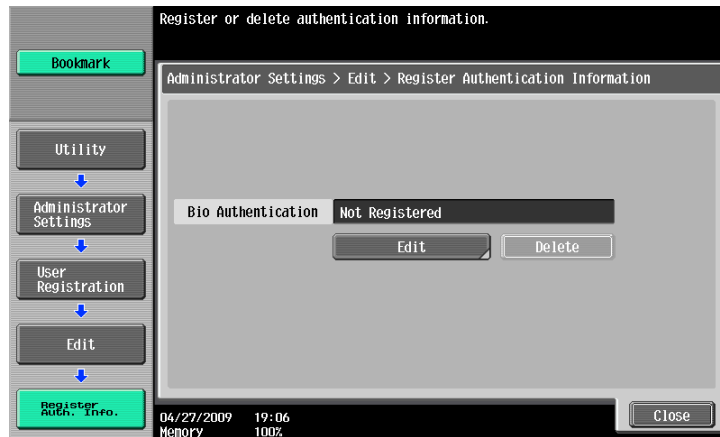

- 6 Place your finger on the authentication unit to scan the finger vein pattern.



- Scan the finger vein pattern three times; reset the same finger each time and then press [Scan] for each scanning.
- After scanning the finger vein patterns, place the same finger on the authentication unit, and press [Authentication Test].
- If your finger vein patterns have been authenticated in the authentication test, press [New]. If authentication has failed, retry scanning the finger.

- 7 Press [Close] twice.
- 8 Enter the user name and password.
- 9 Configure function permission settings as required.
- 10 Press [OK].
- 11 Press [Close].

Registering a user using Data Administrator

To use **Data Administrator**, configure this machine, and set up Data Administrator. For setup, install the **Bi-oDriver (USB-Driver)** of the authentication unit, and then install **Data Administrator Bio Plugin**.

NOTICE

Before setup, install **Data Administrator V4.0** or later in your computer. For the **Data Administrator** operating environment and installation procedure, refer to the **Data Administrator User's Guide**.

Checking the version of the installed Data Administrator

- 1 From the [Help] menu of **Data Administrator**, select [Version Information].

NOTICE

This software cannot be used if the version is "3.x". Install "4.x".

*If **Data Administrator V3.x** is installed, it is removed when **V4.x** is installed.*

- 2 Click [Plug-in version].
- 3 In [Plug-in information list], confirm the plugin version of **Data Administrator**.

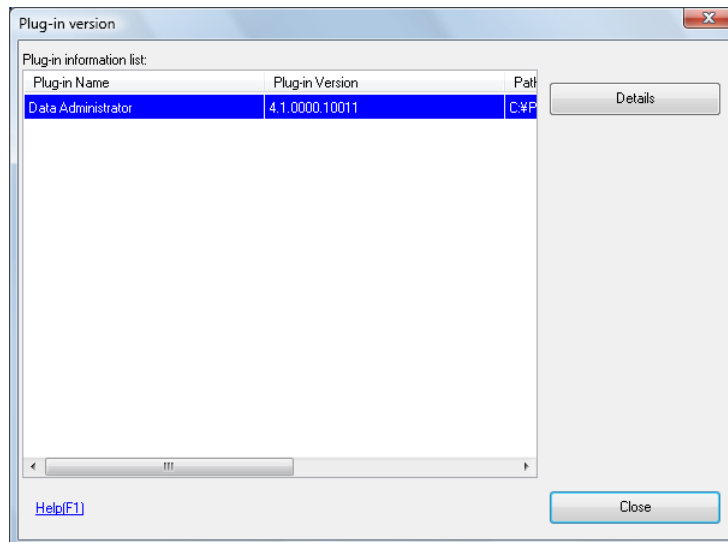

→ This software is available if the plugin version is "4.x".

Setup

- 1 Turn the **Main Power Switch** of this machine off, and disconnect the authentication unit from this machine.
- 2 Install **BioDriver (USB-Driver)**
Connect the authentication unit to the USB port of your computer.
The [Found New Hardware] dialog box appears.
- 3 Select [Locate and install driver software (recommended)].

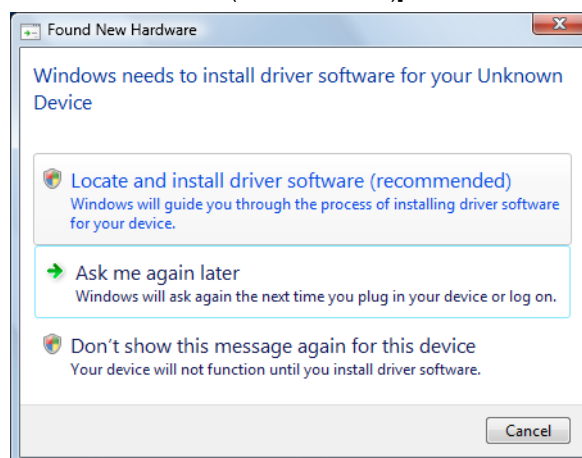

- 4 Insert the application DVD-ROM provided with the authentication unit into the DVD-ROM drive of the computer.

- 5 Click the [Browse my computer for driver software (advanced)].

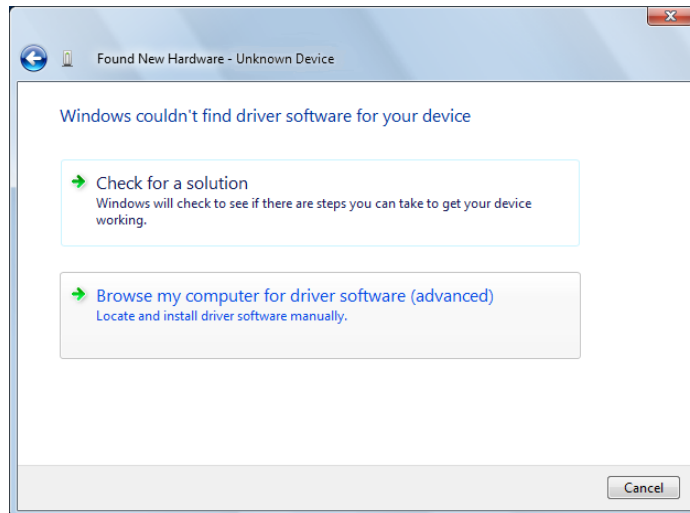

- 6 Check that the driver's search location is the application DVD-ROM, and then click [Next].

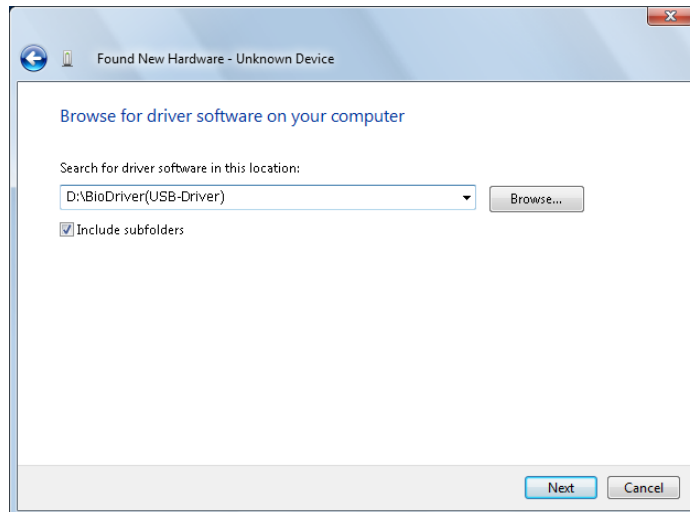

- When the driver's search location is not the application DVD-ROM, click [Browse]. Select the **Bio-Driver (USB-Driver)** folder on the DVD-ROM, and then click [OK].

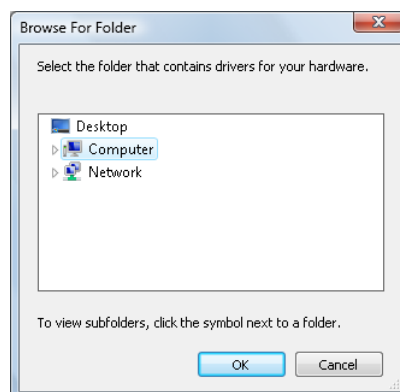

→ Installation starts.

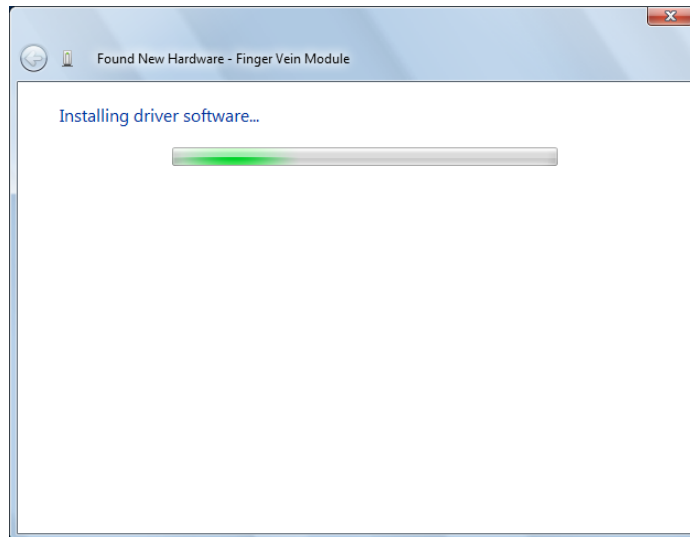

7 Click [Close].

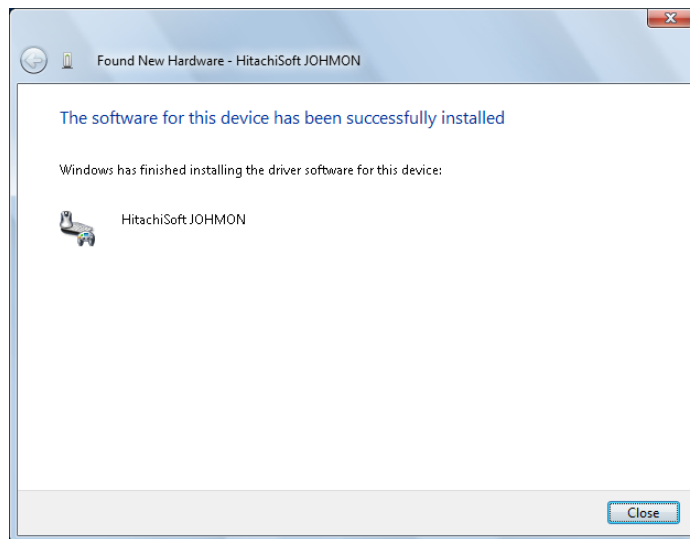

Installation of **BioDriver (USB-Driver)** is completed.

8 Install **Data Administrator Bio Plugin**.

Open the DA_Bio_Plugin folder on the application DVD-ROM, and then click setup.exe.

9 Select a language, and then click [OK].

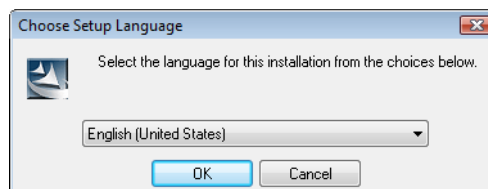

The installation program starts.

10 Follow the on-screen instructions to proceed with the installation.

11 Click [Next].

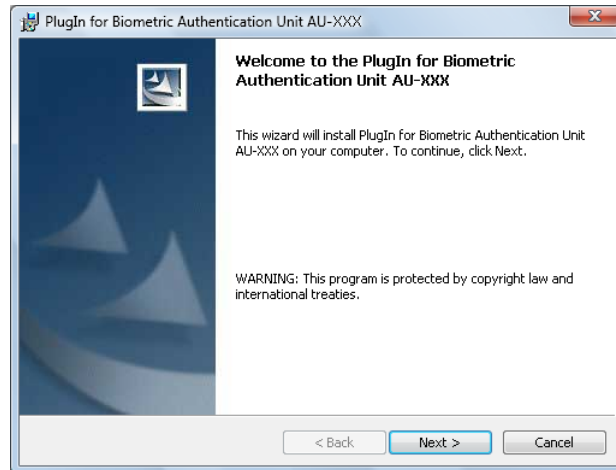

12 Select [I accept the terms in the license agreement], and then click [Next].

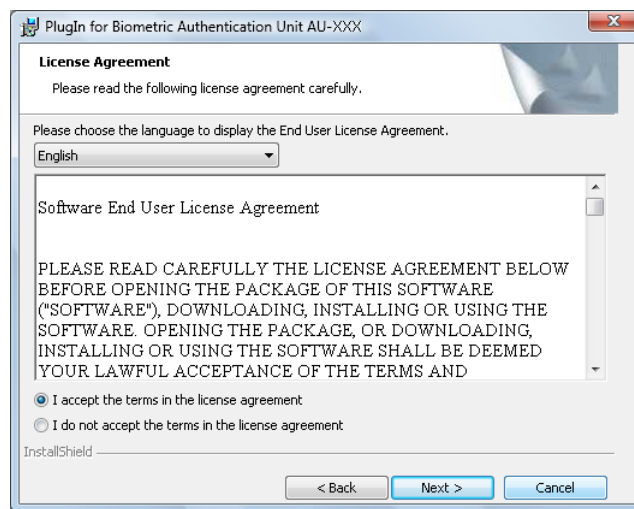

13 Click [Install].

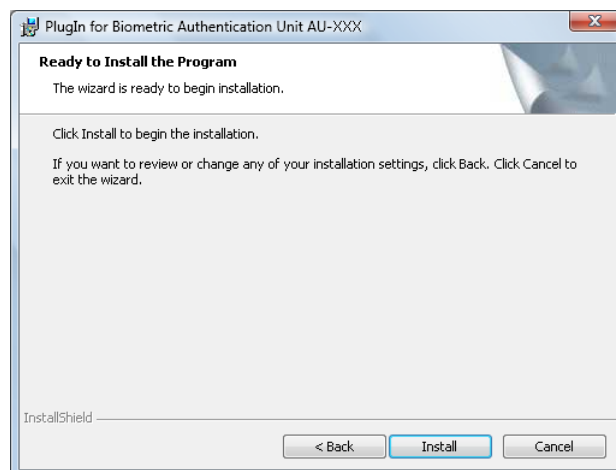

14 Click [Finish].

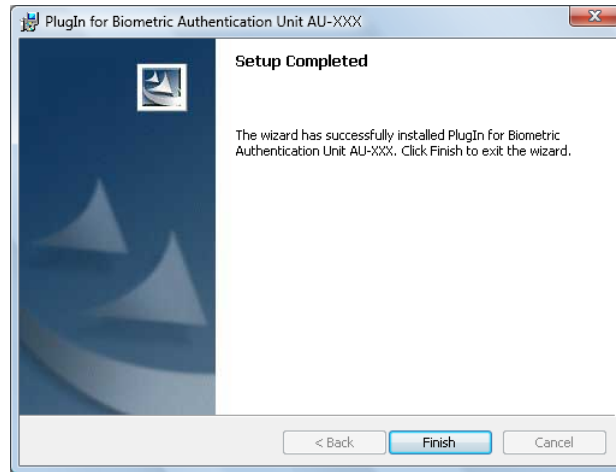

Installation of the **Data Administrator Bio Plugin** is completed, which completes the setup.

User registration

To register a user with **Data Administrator**, connect the authentication unit to the USB port of the computer, and also connect the computer to this machine via network.

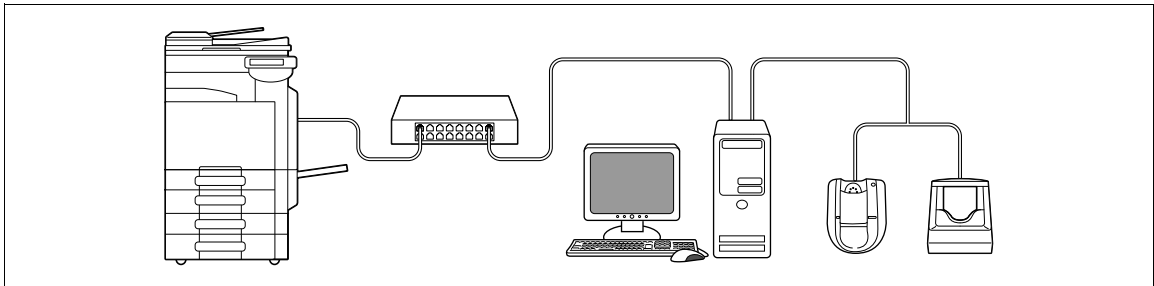

- 1 If the authentication unit is already connected to this machine, turn the **Main Power Switch** of this machine off, and then disconnect the authentication unit.

→ When the authentication unit is already connected to the computer, go to step 4.

NOTICE

To turn the **Main Power Switch** off and on, first turn the **Main Power Switch** off, and then turn it on after 10 or more seconds has elapsed. Not doing so may result in an operation failure.

When connecting or disconnecting the USB cable, hold the plug. Otherwise, the machine may be damaged or a failure may occur.

- 2 Turn on the **Main Power Switch** of this machine.
- 3 Connect the authentication unit to the USB port of the computer that contains **Data Administrator**.

NOTICE

Do not connect another USB device to the same port as for the authentication unit. Doing so reduces the USB power supply, resulting in an operation failure.

To use the USB hub, be sure to connect the self-power USB hub that supplies 500 mA or more.

Restart the procedure 5 or more seconds after connecting the authentication unit.

4 **Data Administrator** starts, and device information of this machine is imported.

The Device Information window appears.

→ For details on how to import device information, refer to the **Data Administrator User's Guide**.

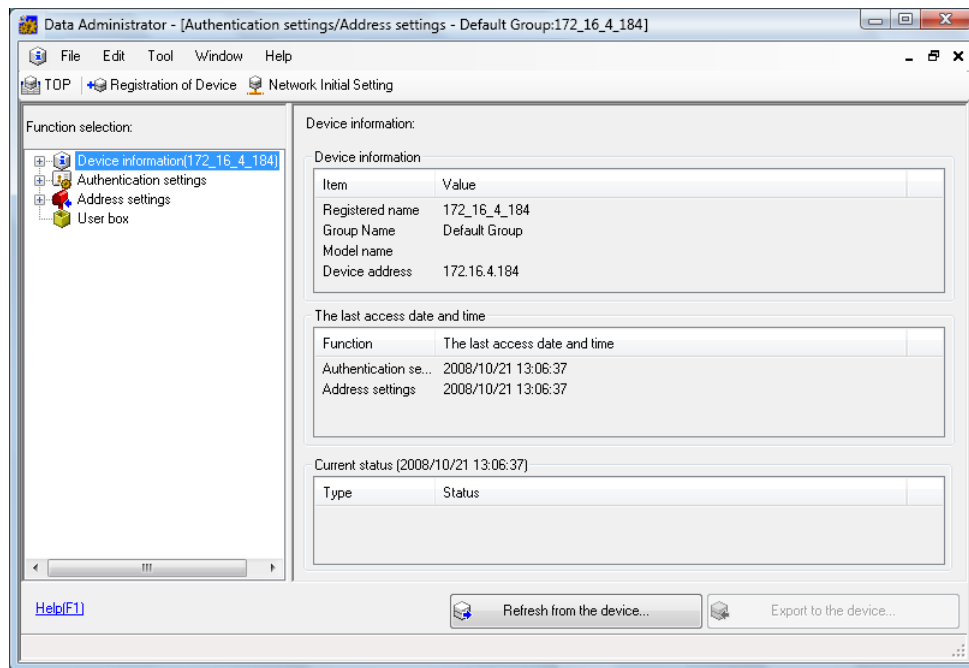

5 In Select Function, select [Authentication Settings] - [User authentication settings], and then click [Add].

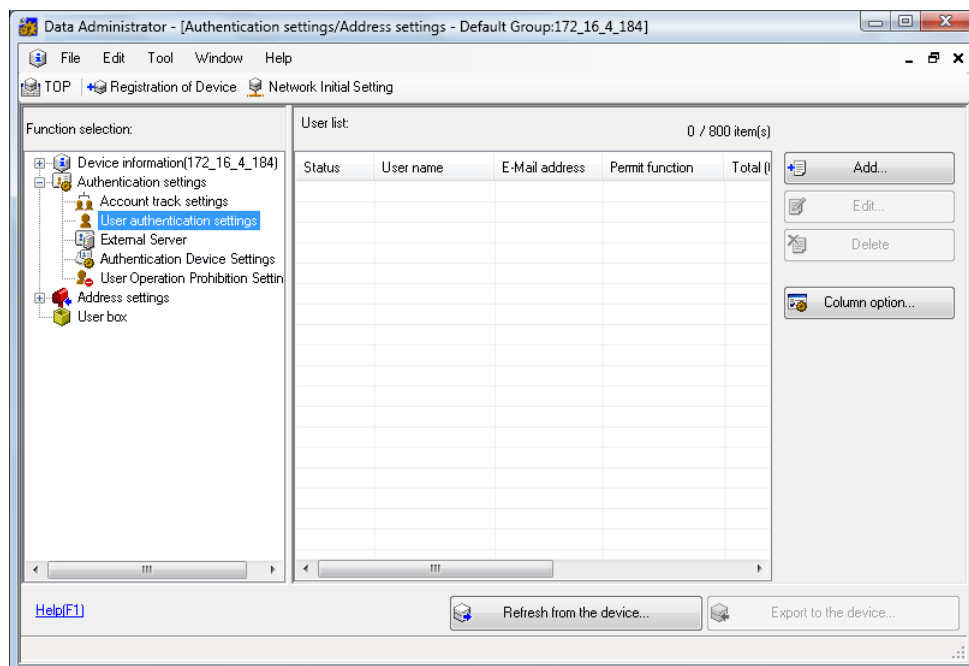

6 Select the desired template, and then click [OK].

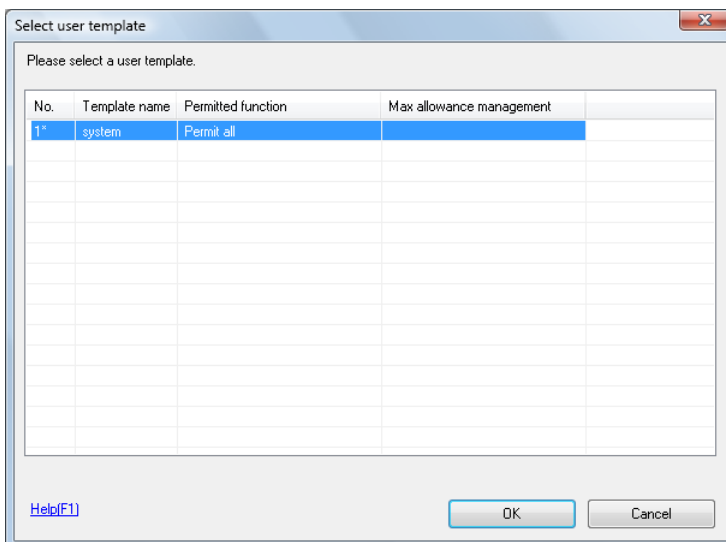

The User Registration window appears.

7 Enter the user name and password, select the [AU-101] or [AU-102] tab, and then click [Register Auth. Info].

→ Enter the E-mail address and other information as required.

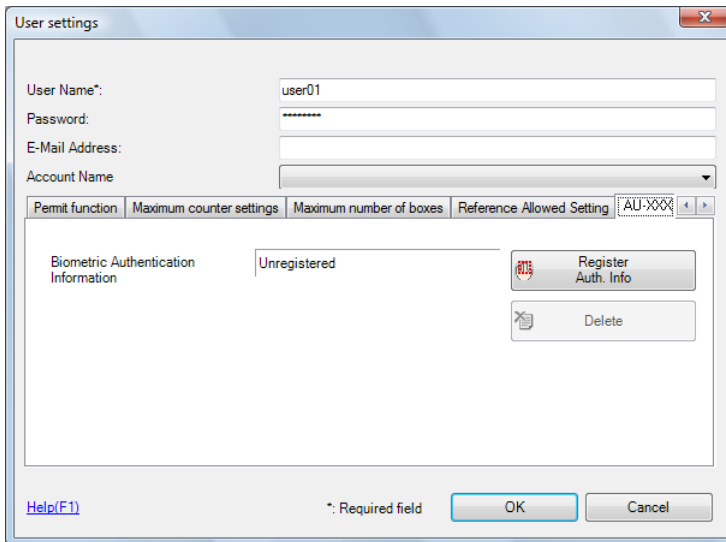

8 Register finger vein patterns.

- Scan the finger vein patterns three times; reset the same finger and then press [Start Reading] for each scanning.
- After scanning the finger vein patterns, place the same finger, and click [Authentication Test].
- If the authentication test has succeeded, press [Register].
- If the authentication test has failed, place your finger on the authentication unit again, and click [Authentication Test].
- If the authentication has failed, click [Reset] to repeat the scanning process.

Authentication Unit (biometric type) AU-101

Register Authentication Information

Biometric data is captured 3 times.

User Name:

Result: Unregistered

Step	Status
1st	Place your finger on the vein reader and click the [Start reading] button.
2nd	-
3rd	-
Test	-



In order to improve the accuracy of authentication data, biometric data is captured 3 times.
If the test repeatedly fails, try another finger.

Authentication Unit (biometric type) AU-102

Register Authentication Information

Biometric data is captured 3 times.

User Name:

Result: Unregistered

Step	Status
1st	Place your finger on the vein reader and click the [Start reading] button.
2nd	-
3rd	-
Test	-



In order to improve the accuracy of authentication data, biometric data is captured 3 times.
If the test repeatedly fails, try another finger.

9 Click [Registration].

10 Click [OK].

→ Repeat steps 5 to 10 to register all users.

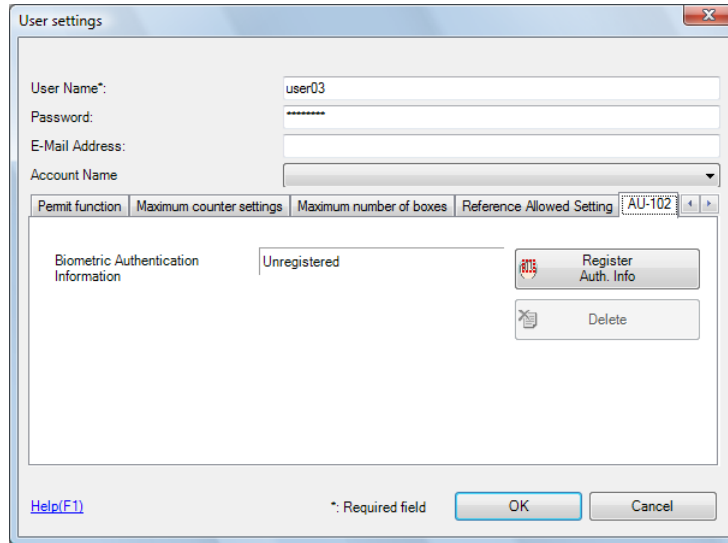

The 'User settings' dialog box contains the following fields and controls:

- User Name: user03
- Password: [masked]
- E-Mail Address: [empty]
- Account Name: [dropdown menu]
- Reference Allowed Setting: AU-102
- Biometric Authentication Information: Unregistered
- Buttons: Register Auth. Info, Delete
- Footer: Help(F1), *: Required field, OK, Cancel

11 Click [Export to the device].

→ Select the user name and click [Edit] to change the registered data.

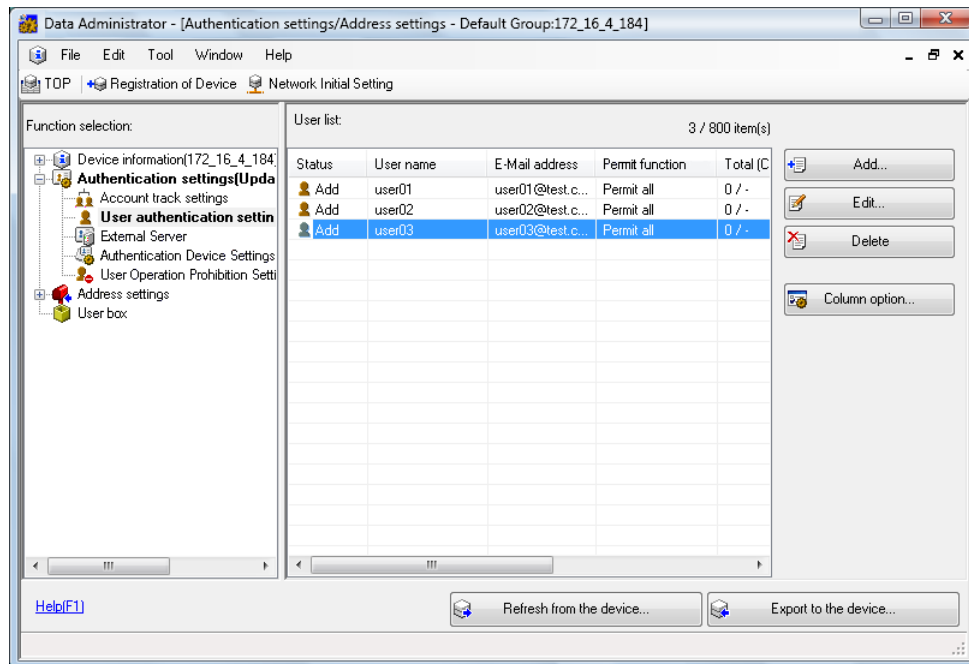

The 'Data Administrator' window shows a tree view on the left and a 'User list' table on the right. The 'User list' table contains the following data:

Status	User name	E-Mail address	Permit function	Total C
Add	user01	user01@test.c...	Permit all	0 / -
Add	user02	user02@test.c...	Permit all	0 / -
Add	user03	user03@test.c...	Permit all	0 / -

Buttons on the right include Add..., Edit..., Delete, and Column option... At the bottom, there are buttons for Refresh from the device... and Export to the device... The left sidebar shows a tree view with 'User authentication settings' selected.

12 Click [Write].

→ **Data Administrator** provides the batch copy function that batch-configures the registered user data in multiple machines with the authentication unit enabled.

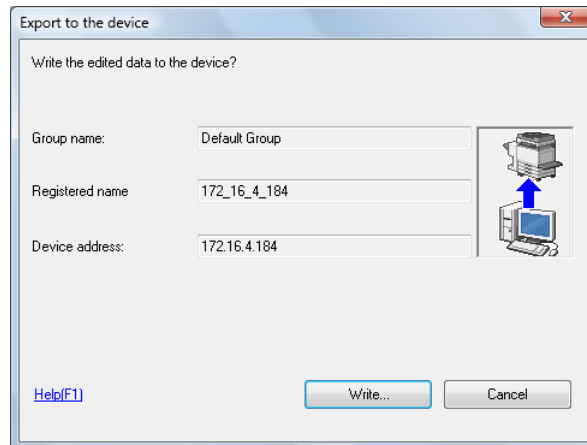

The registered user data is configured in this machine.

13 Click [OK].

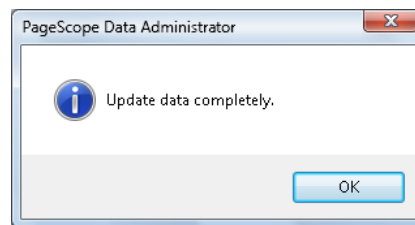

14 Disconnect the authentication unit from the USB port of the computer.

15 Turn the **Main Power Switch** of this machine off, connect the authentication unit to this machine, and turn the **Main Power Switch** of this machine on.

NOTICE

To turn the **Main Power Switch** off and on, first turn the **Main Power Switch** off, and then turn it on after 10 or more seconds has elapsed. Not doing so may result in an operation failure.

When connecting or disconnecting the USB cable, hold the plug. Otherwise, the machine may be damaged or a failure may occur.

10.1.3 Logging in to this machine

This section explains how to log in to this machine with the finger vein pattern authentication.

- To use authentication unit (biometric type), register the finger vein pattern in advance.
- If authentication fails frequently, finger vein patterns may not be registered correctly. Register finger vein patterns again.
- Authentication is carried out when you simply place your finger on the [1-to-many authentication]. Authentication is carried out when you enter the user name and place your finger on the [1-to-1 authentication].
- Press [ID & PW] to [Login] by entering the [User Name] and the [Password], without using the authentication unit.

When [1-to-many authentication] has been specified

- Place your finger on the authentication unit.



Authentication Unit (biometric type) AU-101

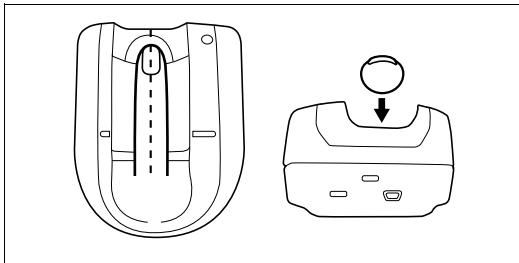

Authentication Unit (biometric type) AU-102

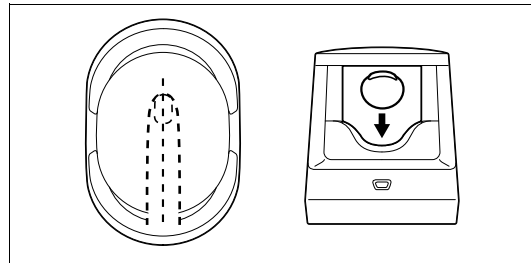

The basic settings screen appears.

When [1-to-1 authentication] has been specified

- 1 Select [User Name], and enter the user name.

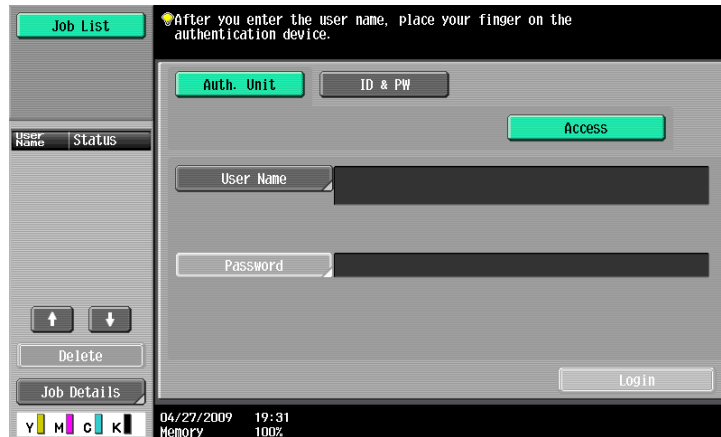

- 2 Place your finger on the authentication unit.

Authentication Unit (biometric type) AU-101

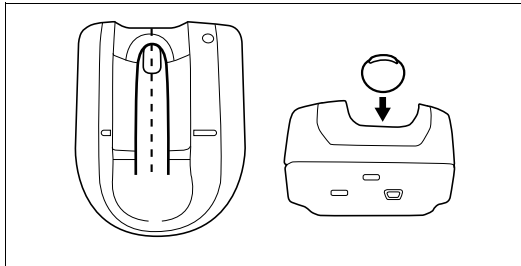

Authentication Unit (biometric type) AU-102

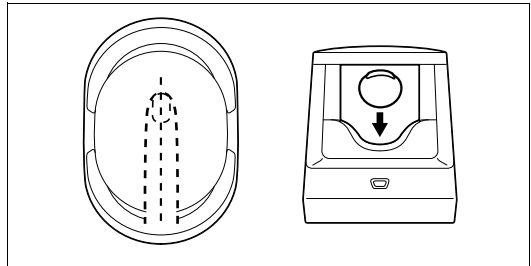

The basic settings screen appears.

11

Authentication unit (IC card type)

11 Authentication unit (IC card type)

This chapter describes the **Authentication Unit (IC card type) AU-201**.

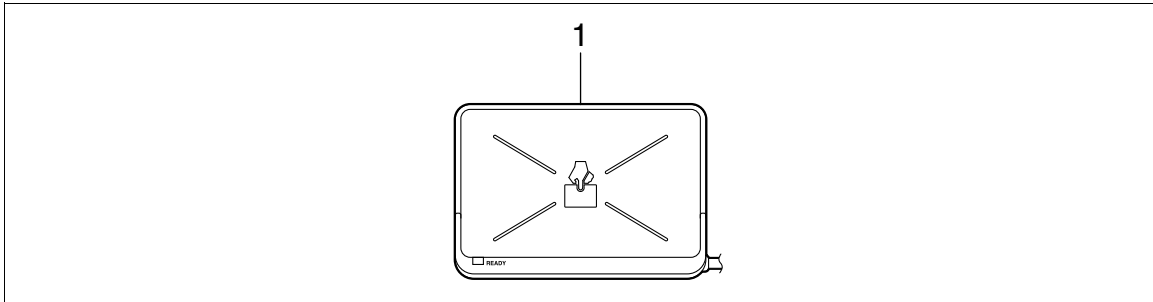

1. Authentication Unit (IC card type) AU-201

11.1 Using authentication unit (IC card type)

The **Authentication Unit (IC card type) AU-201** is an "IC card authentication" system that reads the IC card to perform personal authentication. Using this system, you can perform authentication with an IC card to log in to this machine or execute a print job when User Authentication is enabled in this machine.

To use the authentication unit, first register the card ID of the user in this machine. The registered user, who is authenticated with the card ID, can log in to this machine or execute a print job. This section explains how to configure the required settings in this machine, register users, and log in with authentication.

NOTICE

Authentication Unit (IC card type) AU-201 must be installed inside the **Working Table WT-507** or **Working Table WT-506**.

Do not disconnect the USB cable while using the authentication unit. Doing so may cause the system to become unstable.

Do not leave the IC card within 1-9/16 inch (40 mm) of the card reader.

11.1.1 Configuring this machine

NOTICE

Authentication Unit (IC card type) AU-201 must be installed inside the **Working Table WT-507** or **Working Table WT-506**.

User authentication settings must be configured with MFP authentication on this machine.

This device does not support external server authentication. For [Public User Access] or [Account Track] settings, refer to page 7-27. To combine account track settings with user authentication settings, set Synchronize User Authentication & Account Track to [Synchronize].

- 1** Use the **Control Panel** of this machine to display the Administrator Settings screen. Press [User Authentication/Account Track], then [General Settings].

- 2 Set [User Authentication] to [ON (MFP)], and then press [OK].



- 3 Press [Yes], and then [OK].



- 4 Press [Authentication Device Settings].
- 5 Press [General Settings].
- 6 Press [Card Authentication].
- 7 Configure [IC Card Type] and [Operation Settings].



- In [IC Card Type], specify the required IC card type.
- For [Operation Settings], specify how to log in to this machine after registration.
 - [Card Authentication]: Allows the user to log in by simply placing the IC card.
 - [Card Authentication + Password]: Allows the user to log in by placing the IC card and entering the password.

For details on how to log in to this machine, refer to page 11-16.

- 8 Press [OK] twice.
- 9 Press [Logoff Settings].
- 10 Specify whether to log out the user when scanning the original has finished after the user logged in with the authentication unit.

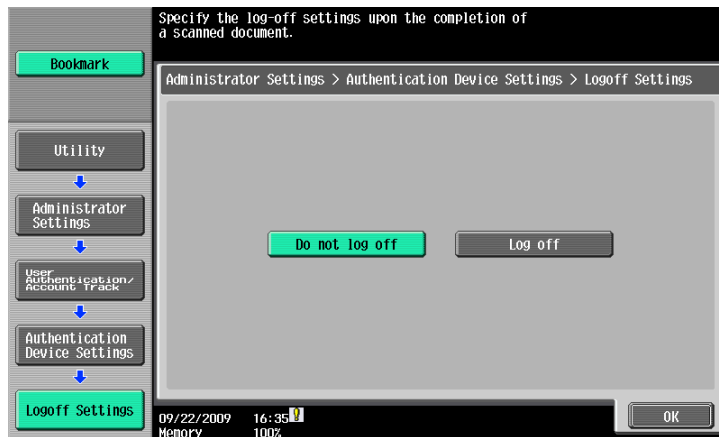

- 11 Press [OK].
- 12 Press [Close] twice.

11.1.2 Registering a user

The following two methods can be used to register a user.

- Connect the authentication unit to this machine, and directly register the target user in this machine
- Connect the authentication unit to your computer, and use **Data Administrator** to register the target user

NOTICE

The registered user data is saved in the HDD of this machine. Changing the user authentication type of this machine or formatting the HDD will erase the registered user data.

Registering a user using the Control Panel of this machine

- 1 Use the **Control Panel** of this machine to display the Administrator Settings screen. Press [User Authentication/Account Track], and then [User Authentication Settings].
- 2 Press [User Registration].
- 3 Select a desired registration number, and then press [Edit].



- 4 Press [Register Auth. Info.].



- 5 Press [Edit].

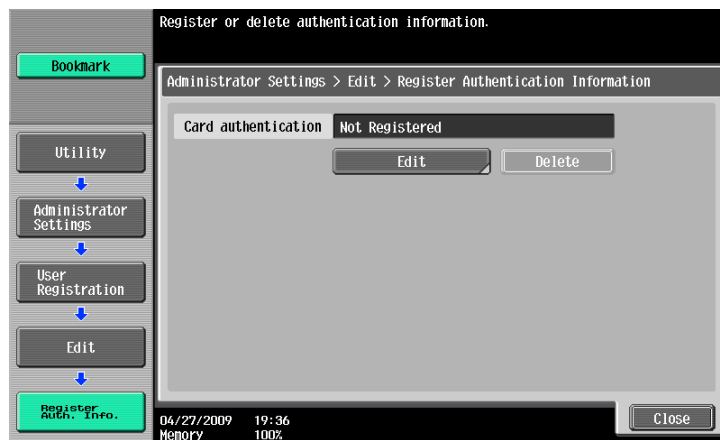

- 6 Place the IC card on the authentication unit, and press [OK].



- 7 When message [Registration complete.] appears, press [Close] twice.
- 8 Enter the user name and password.
- 9 Configure function permission settings as required.
- 10 Press [OK].
- 11 Press [Close].

Registering a user using Data Administrator

To use **Data Administrator**, configure this machine, and set up Data Administrator. For setup, install the **IC Card Driver (USB-Driver)** of the authentication unit, and then install **Data Administrator IC Card Plugin**.

NOTICE

Before setup, install **Data Administrator V4.0** or later in your computer. For the **Data Administrator** operating environment and installation procedure, refer to the **Data Administrator User's Guide**.

Checking the version of the installed Data Administrator

- 1 From the [Help] menu of **Data Administrator**, select [Version Information].

NOTICE

This software cannot be used if the version is "3.x". Install "4.x".

If **Data Administrator V3.x** is installed, it is removed when **V4.x** is installed.

- 2 Click [Plug-in version].
- 3 In [Plug-in information list], confirm the plugin version of **Data Administrator**.

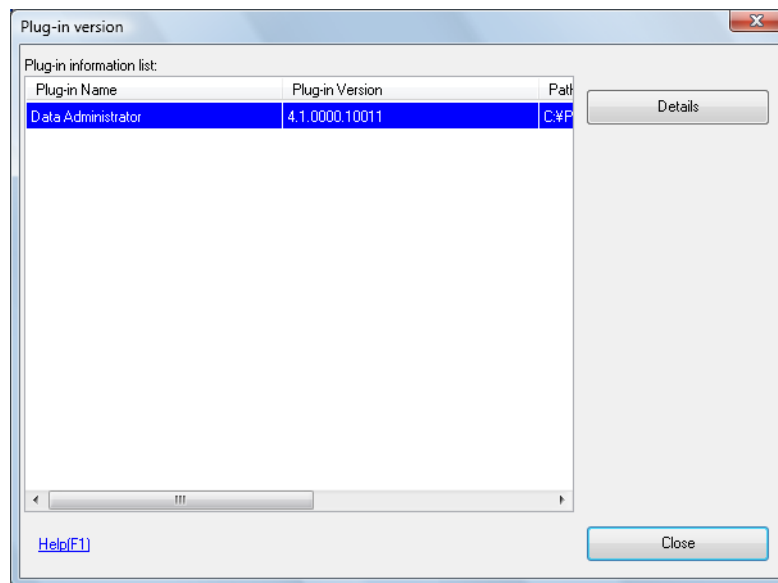

→ This software is available if the plugin version is "4.x".

Setup

- 1 Turn the **Main Power Switch** of this machine off, and disconnect the authentication unit from this machine.
- 2 Install **IC Card Driver (USB-Driver)**.
Connect the authentication unit to the USB port of your computer.
The [Found New Hardware] dialog box appears.
- 3 Select [Locate and install driver software (recommended)].

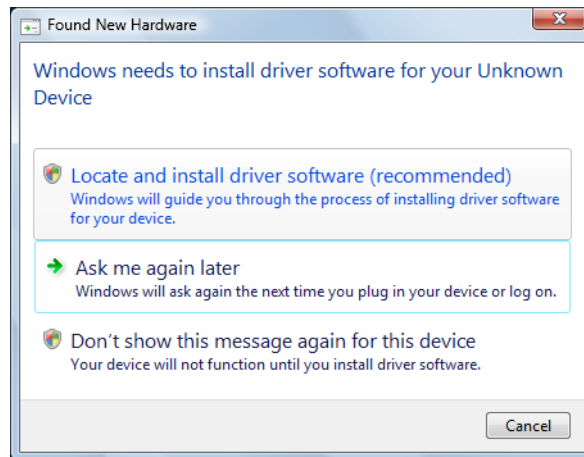

- 4 Insert the application DVD-ROM provided with the authentication unit into the DVD-ROM drive of the computer.
- 5 Click the [Browse my computer for driver software (advanced)].

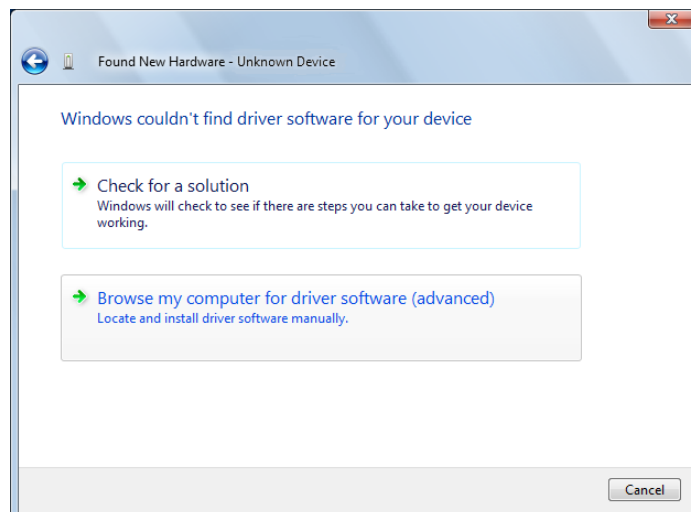

- 6 Check that the driver's search location is the application DVD-ROM, and then click [Next].

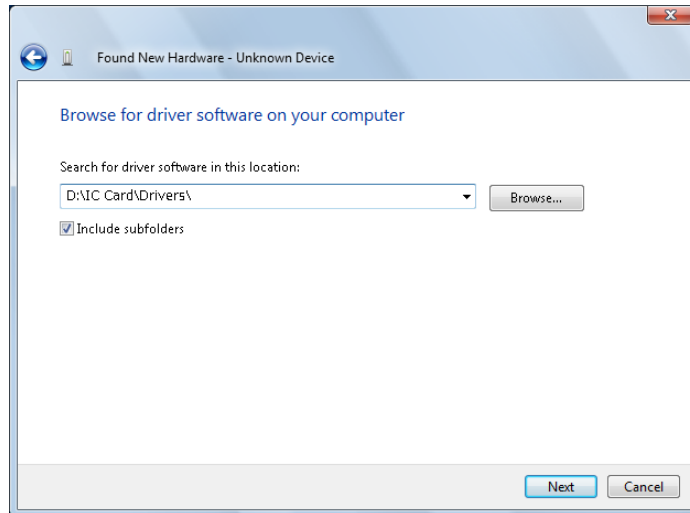

- When the driver's search location is not the application DVD-ROM, click [Browse]. Select the **IC Card Driver (USB-Driver)** folder in the DVD-ROM, and click [OK].

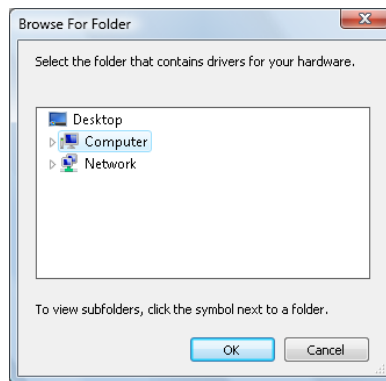

- Installation starts.

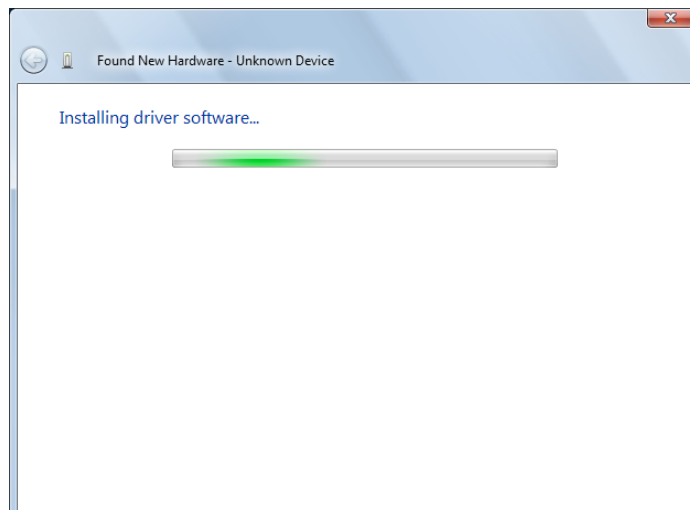

- 7 Click [Close].

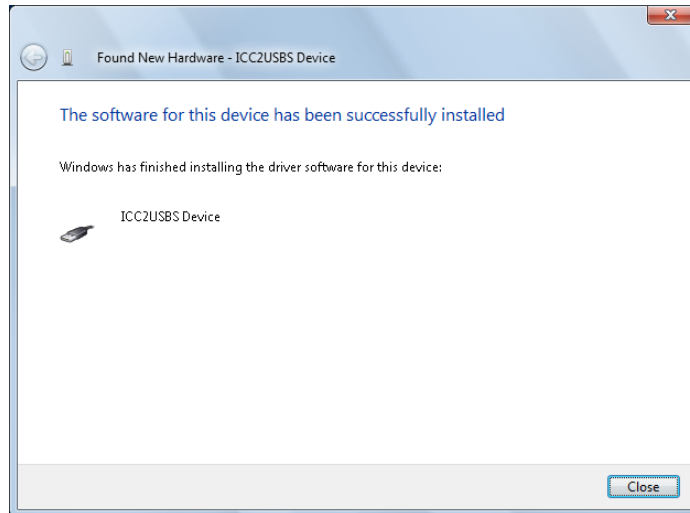

Installation of the **IC Card Driver (USB-Driver)** is completed.

- 8 Install **Data Administrator IC Card Plugin**.
Open the IC_Card_Plugin folder on the application DVD-ROM, and then click setup.exe.
- 9 Select a language, and then click [OK].

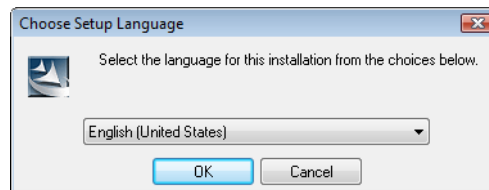

The installation program starts.

- 10 Follow the on-screen instructions to proceed with the installation.
- 11 Click [Next].



- 12 Select [I accept the terms in the license agreement], and then click [Next].

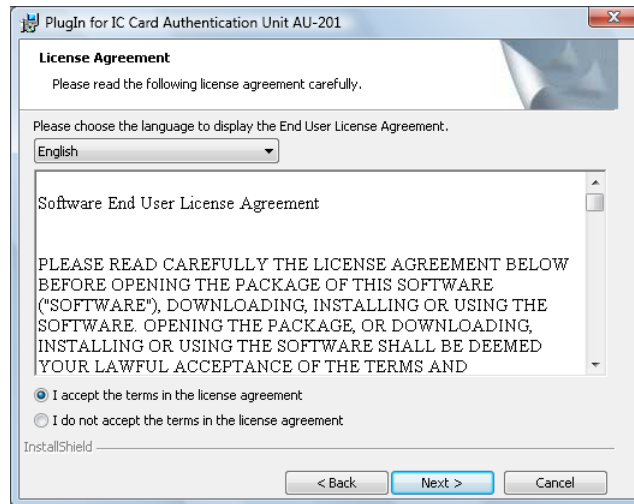

- 13 Click [Install].

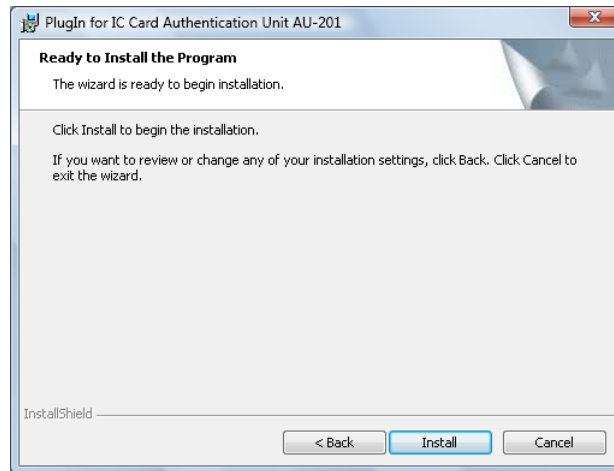

- 14 Click [Finish].

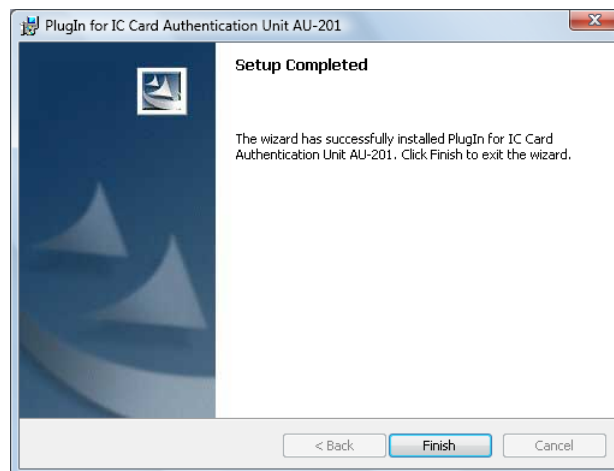

Installation of the **Data Administrator IC Card Plugin** is completed, which completes the setup.

User registration

To register a user with **Data Administrator**, connect the authentication unit to the USB port of the computer, and also connect the computer to this machine via network.

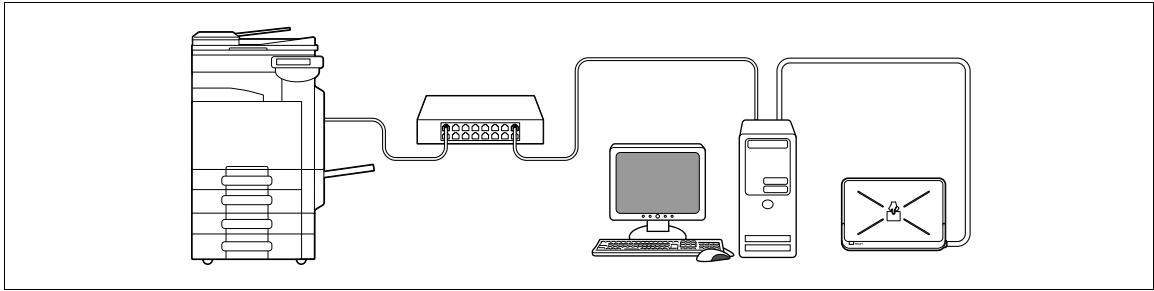

- 1 If the authentication unit is already connected to this machine, turn the **Main Power Switch** of this machine off, and then disconnect the authentication unit.

→ When the authentication unit is already connected to the computer, go to step 4.

NOTICE

To turn the **Main Power Switch** off and on, first turn the **Main Power Switch** off, and then turn it on after 10 or more seconds has elapsed. Not doing so may result in an operation failure.

When connecting or disconnecting the USB cable, hold the plug. Otherwise, the machine may be damaged or a failure may occur.

- 2 Turn on the **Main Power Switch** of this machine.

- 3 Connect the authentication unit to the USB port of the computer that contains **Data Administrator**.

NOTICE

Do not connect another USB device to the same port as for the authentication unit. Doing so reduces the USB power supply, resulting in an operation failure.

To use the USB hub, be sure to connect the self-power USB hub that supplies 500 mA or more.

Restart the procedure 5 or more seconds after connecting the authentication unit.

- 4 **Data Administrator** starts, and device information of this machine is imported.

The Device Information window appears.

→ For details on how to import device information, refer to the **Data Administrator** User's Guide.

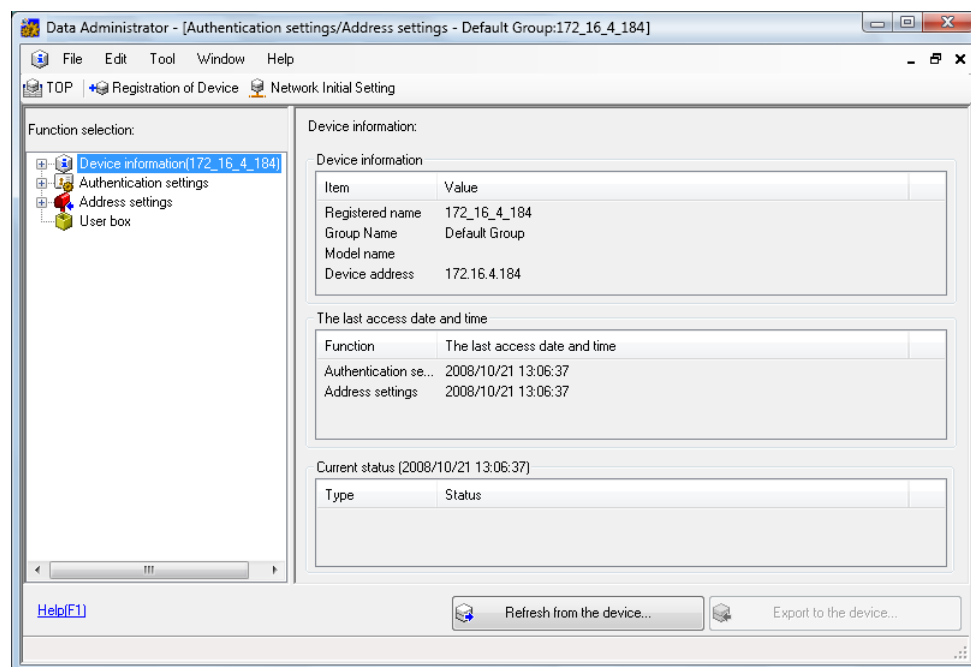

- 5 In Select Function, select [Authentication Settings] - [User authentication settings], and then click [Add].

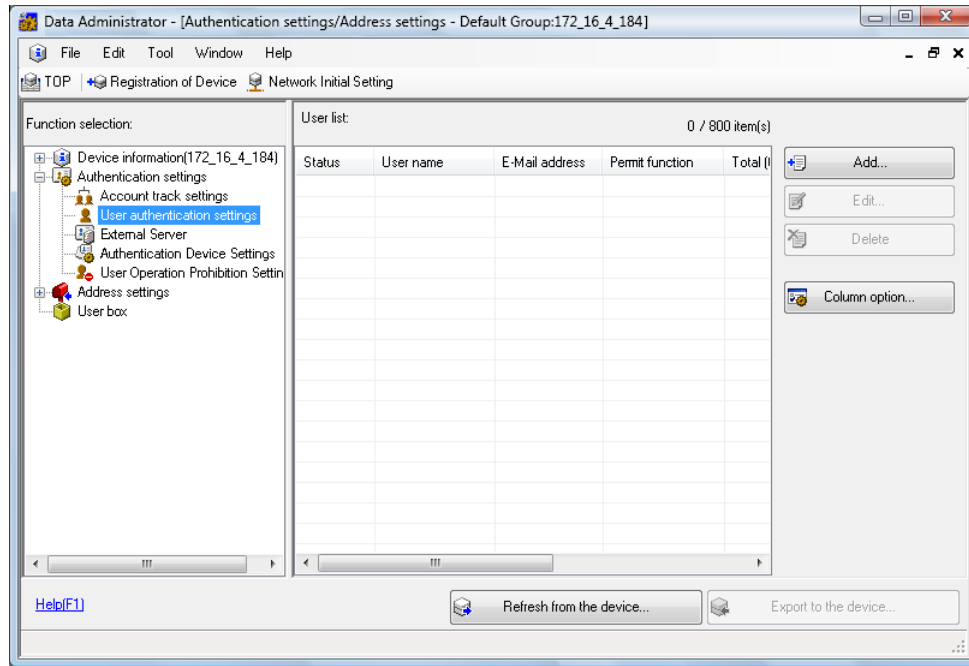

- 6 Select the desired template, and then click [OK].

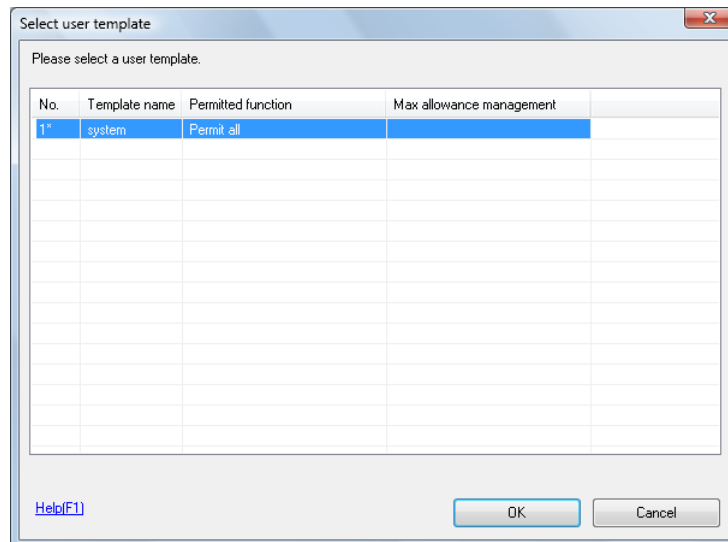

The User Registration window appears.

- 7 Enter the user name and password, and select the [IC card authentication] tab.
→ Enter the E-mail address and other information as required.

The screenshot shows the 'User settings' dialog box. The 'User Name' field contains 'user01', the 'Password' field is masked with asterisks, and the 'E-Mail Address' field is empty. The 'Account Name' dropdown is also empty. Below these fields are four tabs: 'Maximum counter settings', 'Maximum number of boxes', 'Reference Allowed Setting', and 'IC card authentication'. The 'IC card authentication' tab is selected, showing 'Card Type' as 'FeliCa', 'Scan Result' as 'Unregistered', and an empty 'Card ID' field. To the right of the 'Card ID' field are three buttons: 'Start reading', 'Delete', and 'Card ID Input'. At the bottom of the dialog, there is a 'Help(F1)' link, a '*: Required field' indicator, and 'OK' and 'Cancel' buttons.

- 8 Place the IC card on the authentication unit, and click [Start reading].
→ If necessary, click [Card ID Input] to register the card ID.
- 9 Click [OK].
→ Repeat steps 5 to 9 to register all users.

The screenshot shows the 'User settings' dialog box for user 'user03'. The 'User Name' field contains 'user03', the 'Password' field is masked with asterisks, and the 'E-Mail Address' field is empty. The 'Account Name' dropdown is also empty. Below these fields are four tabs: 'Maximum counter settings', 'Maximum number of boxes', 'Reference Allowed Setting', and 'IC card authentication'. The 'IC card authentication' tab is selected, showing 'Card Type' as 'FeliCa', 'Scan Result' as 'Unregistered', and an empty 'Card ID' field. To the right of the 'Card ID' field are three buttons: 'Start reading', 'Delete', and 'Card ID Input'. At the bottom of the dialog, there is a 'Help(F1)' link, a '*: Required field' indicator, and 'OK' and 'Cancel' buttons.

- 10 Click [Export to the device].
 → Select the user name and click [Edit] to change the registered data.

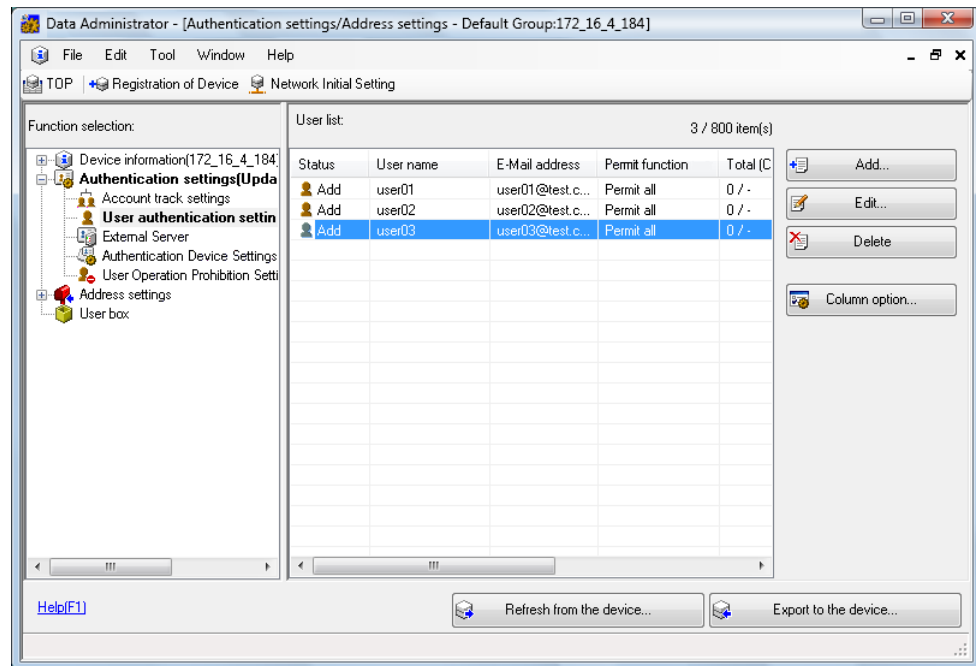

- 11 Click [Write].
 → **Data Administrator** provides the batch copy function that batch-configures the registered user data in multiple machines with the authentication unit enabled.

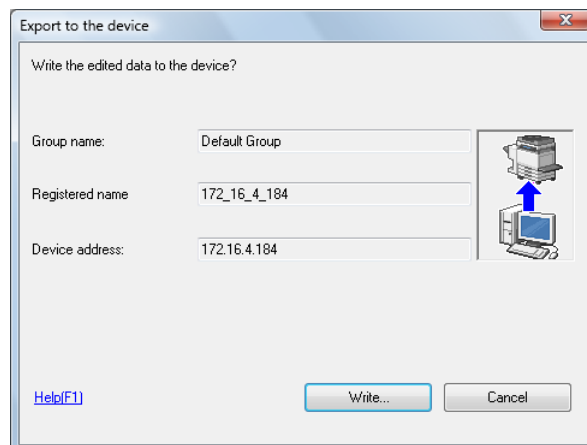

The registered user data is configured in this machine.

- 12 Click [OK].

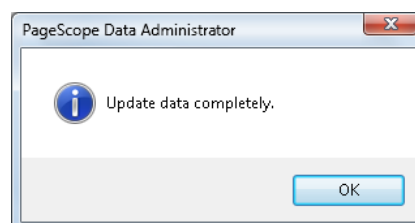

- 13 Disconnect the authentication unit from the USB port of the computer.

- 14 Turn the **Main Power Switch** of this machine off, connect the authentication unit to this machine, and turn the **Main Power Switch** of this machine on.

NOTICE

To turn the **Main Power Switch** off and on, first turn the **Main Power Switch** off, and then turn it on after 10 or more seconds has elapsed. Not doing so may result in an operation failure.

When connecting or disconnecting the USB cable, hold the plug. Otherwise, the machine may be damaged or a failure may occur.

11.1.3 Logging in to this machine

This section explains how to log in to this machine with IC card authentication.

- To use authentication unit (IC card type), register the information recorded in the IC card in advance.
- If authentication fails frequently, IC card information may not be registered properly. Register IC card information again.
- When the IC Card authentication is enabled, a registered user is authenticated by simply placing the IC card. Authentication is carried out when you place the IC card and enter the [Password] when both IC cards and passwords are used for authentication.
- Press [ID & PW] to [Login] by entering the [User Name] and the [Password], without using the authentication unit.

When [Card Authentication] is enabled

- Place the IC card on the **Working Table WT-507** or **Working Table WT-506**.

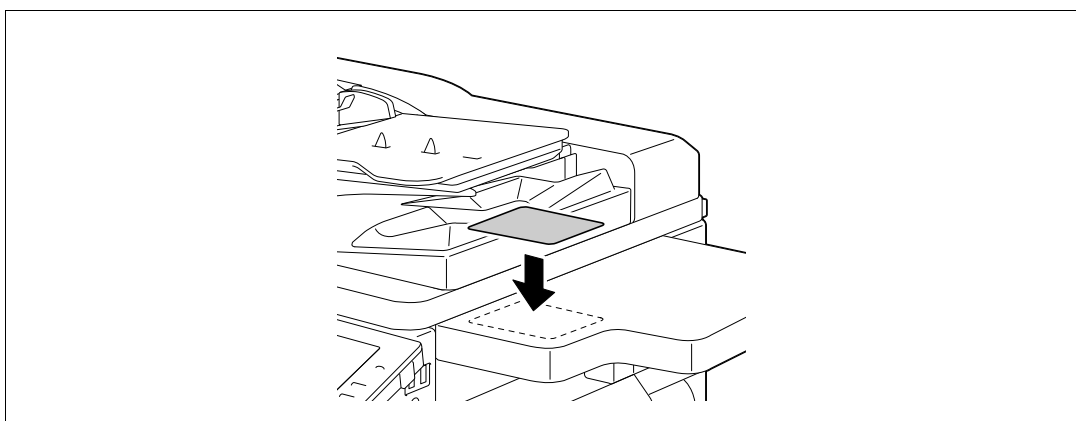
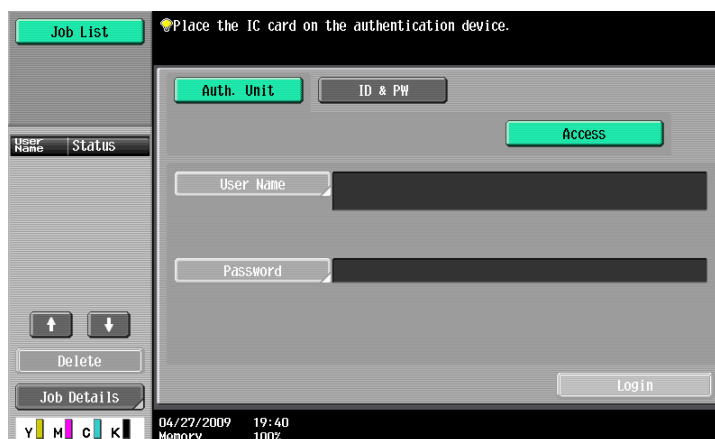

The basic settings screen appears.

When [Card Authentication + Password] is enabled

- 1 Place the IC card on the **Working Table WT-507** or **Working Table WT-506**.

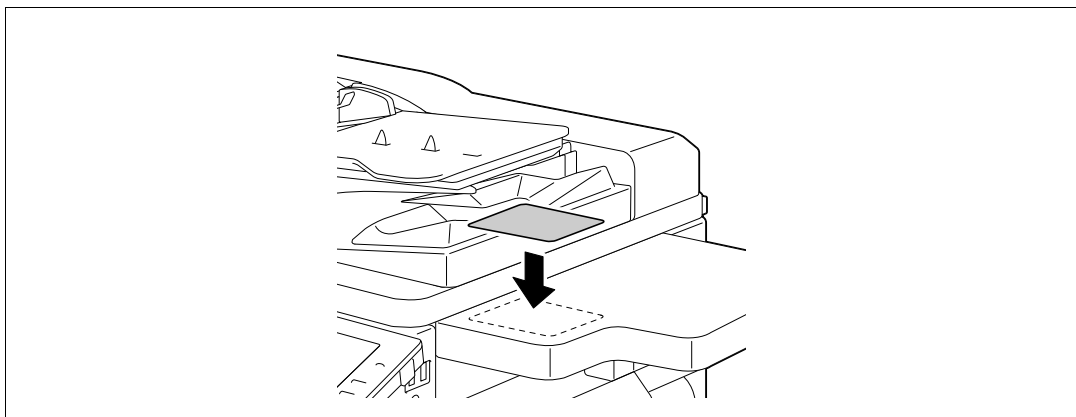

- 2 Press [Password], and enter the password.



- 3 Press [Login] or the **Access** key.
The basic settings screen appears.

12 Specifications

12 Specifications

This chapter describes the specifications of the paper, machine, and options.

This product specification is subject to change without notice toward the improvement.

12.1 Paper

Paper types and paper capacities

Paper Type	Paper weight	Paper capacity
Plain paper Single Side Only ^{*1} Special Paper ^{*2} Letterhead ^{*3} Colored Paper ^{*4} User Paper 1 ^{*5} User Paper 2 ^{*5}	15-15/16 lb to 23-15/16 lb (60 g/m ² to 90 g/m ²)	Bypass Tray: 150 sheets Tray 1: 500 sheets Tray 2: 500 sheets Paper Feed Cabinet PC-107: 500 sheets Paper Feed Cabinet PC-207: 500 sheets Paper Feed Cabinet PC-408: 2500 sheets
Thick 1 User Paper 3 ^{*5}	24-3/16 lb to 39-7/8 lb (91 g/m ² to 150 g/m ²)	Bypass Tray: 20 sheets Tray 1: 150 sheets Tray 2: 150 sheets Paper Feed Cabinet PC-107: 150 sheets Paper Feed Cabinet PC-207: 150 sheets Paper Feed Cabinet PC-408: 1000 sheets
Thick 2 User Paper 4 ^{*5}	40-3/16 lb to 55-5/8 lb (151 g/m ² to 209 g/m ²)	Bypass Tray: 20 sheets Tray 1: 150 sheets Tray 2: 150 sheets Paper Feed Cabinet PC-107: 150 sheets Paper Feed Cabinet PC-207: 150 sheets Paper Feed Cabinet PC-408: 1000 sheets
Thick 3 User Paper 5 ^{*5}	55-7/8 lb to 68-1/8 lb (210 g/m ² to 256 g/m ²)	Bypass Tray: 20 sheets Tray 1: 150 sheets Tray 2: 150 sheets Paper Feed Cabinet PC-107: 150 sheets Paper Feed Cabinet PC-207: 150 sheets Paper Feed Cabinet PC-408: 1000 sheets
Thick 4	68-3/8 lb to 72-1/16 lb (257 g/m ² to 271 g/m ²)	Bypass Tray: 20 sheets
Transparency	–	Bypass Tray: 20 sheets
Postcards	–	Bypass Tray: 20 sheets
Envelope	–	Bypass Tray: 10 sheets
Label sheets	–	Bypass Tray: 20 sheets
Banner paper	33-13/16 lb to 42-9/16 lb (127 g/m ² to 160 g/m ²)	Bypass Tray: 10 sheets

^{*1} Paper where you do not print on both sides (for example, when something is already printed on the front side).

^{*2} Fine and other special paper.

^{*3} Paper where company names, preset text, and others are already printed.

^{*4} Colored paper.

^{*5} Paper that is registered as one of frequently used paper types.

For paper weight and media adjustment settings, contact your service representative.

NOTICE

Paper other than plain paper, such as OHP transparencies and colored paper, is called special paper. Be sure to select a special paper setting for paper trays loaded with media such as OHP transparencies and colored paper.































If the paper size or paper type is not correctly specified, it will result in a paper jam or image failure.

*When you select Plain Paper, Thick 1, Thick 2, Thick 3, or Thick 4 for the **Bypass Tray**, you can select Duplex 2nd Side. Select Duplex 2nd Side when you load paper where something is printed on one side.*

12.2 Machine specifications

d-Color MF360/280/220

Specifications

Type	Scanner, printer, desktop, or stand-alone	
Document holder	Stationary (mirror scanning)	
Photo conductor	OPC	
Light source	White rare-gas fluorescent	
Copy system	Laser electrostatic copying	
Developing system	Dry 2-component HMT developing system	
Fusing system	Belt fusing	
Resolution	Scanning	600 dpi × 600 dpi
	Output	1800 dpi equivalent × 600 dpi
Originals	Type	Sheets, books (two-page spread), three-dimensional objects
	Size	Max. 11 × 17 (A3)
	Weight	4-7/16 lb (2 kg) (Three-dimensional objects)
Copying paper type	Plain paper (15-15/16 lb to 23-15/16 lb (60 g/m ² to 90 g/m ²)), Thick 1 (24-3/16 lb to 39-7/8 lb (91 g/m ² to 150 g/m ²)), Thick 2 (40-3/16 lb to 55-5/8 lb (151 g/m ² to 209 g/m ²)), Thick 3 (55-7/8 lb to 68-1/8 lb (210 g/m ² to 256 g/m ²)), Thick 4 (68-3/8 lb to 72-1/16 lb (257 g/m ² to 271 g/m ²)), Letterhead, Colored paper, Transparency, Postcard, Envelope, Label sheet, Banner paper (33-13/16 lb to 42-9/16 lb (127 g/m ² to 160 g/m ²))* 2-Sided: Plain paper (17 lb to 23-15/16 lb (64 g/m ² to 90 g/m ²)), Thick 1/2/3 (24-3/16 lb to 68-1/8 lb (91 g/m ² to 256 g/m ²)) * Available for Bypass Tray .	
Copy paper size	<p><Tray 1> 11 × 17  to 8-1/2 × 11 , 5-1/2 × 8-1/2 , A3 , to A5 , 8 × 13 ^{*1}, 16K , 8K </p> <p><Tray 2> 12-1/4 × 18  to 8-1/2 × 11 , 5-1/2 × 8-1/2 , A3  to A5 , 8 × 13 ^{*1}, 16K , 8K </p> <p><Bypass Tray> Banner Paper^{*2}, 12 × 18  to 5-1/2 × 8-1/2 , A3  to B6 , A6 , 4 × 6 , 8 × 13 ^{*1}, A6 card , 16K , 8K  Width: 3-9/16 to 12-1/4 (90 mm to 311.1 mm), Length: 5-1/2 to 47-1/4 (139.7 mm to 1200 mm) ^{*1} There are six types of foolscap: 8-1/2 × 13-1/2 , 220 mm × 330 mm , 8-1/4 × 13 , 8-1/8 × 13-1/4 , and 8 × 13 . Any one of these sizes is selectable. For details, contact your service representative. ^{*2} Banner paper Width: 8-1/4 to 11-11/16 inches (210 to 297 mm) Length: 18 to 47-1/4 inches (457.3 to 1200 mm)</p>	
Number of sheets loaded in Output Tray	Plain paper	250 sheets
	Thick	10 sheets
	Transparency	1 sheet
Paper tray capacity (8-1/2 × 11(A4))	Tray 1/Tray 2	Plain paper: 500 sheets, Thick 1/2/3: 150 sheets
	Bypass Tray	Plain paper: 150 sheets, Thick 1/2/3/4: 20 sheets, Transparency/Postcard/Label sheet: 20 sheets, Envelope: 10 sheets















Specifications

Warm-up time	<p>Period from the time the Main Power Switch was turned on to the time Sub Power Switch was turned on to get ready for printing (room temperature: 73.4 °F (23 °C))</p> <p>d-Color MF360/280 Full color: 35 sec. or less, Black: 27 sec. or less</p> <p>d-Color MF220 Full color: 27 sec. or less, Black: 22 sec. or less</p> <p>Period from the time Main Power Switch was turned on to the time this machine is ready for printing (room temperature: 73.4 °F (23 °C)) 45 sec. or less</p> <p>Warm-up time may vary depending on the operating environment and usage.</p>	
Image chipping width	Top edge	3/16 (4.2 mm)
	Bottom edge	1/8 (3.0 mm)
	Right edge	1/8 (3.0 mm)
	Left edge	1/8 (3.0 mm)
First copy (When printing 8-1/2 × 11 (A4))	<p>d-Color MF360/280 Full color: 7.7 sec. or less Black: 5.8 sec. or less</p> <p>d-Color MF220 Full color: 11.0 sec. or less Black: 7.5 sec. or less</p>	
Copy speed (When printing 8-1/2 × 11 (A4))	1-Sided (Full color/Black)	<p>d-Color MF360 36 sheets/min. (Special paper/Glossy mode: 11.8 sheets/min.)</p> <p>d-Color MF280 28.8 sheets/min. (Special paper/Glossy mode: 11.8 sheets/min.)</p> <p>d-Color MF220 22.7 sheets/min. (Special paper/Glossy mode: 11.8 sheets/min.)</p>
	2-Sided (Full color/Black)	<p>d-Color MF360 34.9 sheets/min. (Special paper/Glossy mode: 11.8 sheets/min.)</p> <p>d-Color MF280 28.8 sheets/min. (Special paper/Glossy mode: 11.8 sheets/min.)</p> <p>d-Color MF220 22.7 sheets/min. (Special paper/Glossy mode: 11.7 sheets/min.)</p>
Copy magnification	<p>Full size: 100.0% ± 0.5%</p> <p>Enlarge <Inch area>: 121.4%, 129.4%, 154.5%, 200.0% <Metric area>: 115.4%, 122.4%, 141.4%, 200.0%</p> <p>Reduce <Inch area>: 78.5%, 73.3%, 64.7%, 50.0% <Metric area>: 86.6%, 81.6%, 70.7%, 50.0%</p> <p>Manual: 25.0 to 400.0% (in 0.1% steps)</p>	
Number of continuous copies	1 to 9999 sheets	
Density adjustment	Copy density	Manual density adjustment (9 levels)
	Background density	Manual or automatic density adjustment (9 levels)
Power supply	AC 120 V, 12 A, 60 Hz (AC 220 V to 240 V, 8.0 A, 50/60 Hz)	
Max. power consumption	1500 W	
Size	<p>Width 25-5/16 (643 mm) Depth 27-3/4 (705 mm), 33-3/8* (842 mm*) Height 30-5/16 (770 mm) *Size including the panel</p>	

Specifications

Machine occupation dimensions	Width 64-15/16 (1,649 mm) Depth 49-5/8 (1,260 mm) Height 62-1/2 (1,588 mm) The dimensions above are measured when the tray extension or paper tray of the Finisher FS-527 is pulled out while the ADF remains opened.
Memory size (hard disk capacity)	2,048 MB (250 GB)
Weight	Approx. 216-1/16 lb (Approx. 98 kg)







Auto Duplex Unit**Specifications**

Paper Type	Plain paper (17 lb to 23-15/16 lb (64 g/m ² to 90 g/m ²)), Thick 1 (24-3/16 lb to 39-7/8 lb (91 g/m ² to 150 g/m ²)), Thick 2 (40-3/16 lb to 55-5/8 lb (151 g/m ² to 209 g/m ²)), Thick 3 (55-7/8 lb to 68-1/8 lb (210 g/m ² to 256 g/m ²))
Paper Size	12-1/4 × 18  , 12 × 18  to 5-1/2 × 8-1/2  , A3  to A5  , 8 × 13  ^{*1} , 16K  , 8K  Width: 5-1/2 to 12-1/4 (139.7 mm to 311.1 mm), Length: 5-13/16 to 18 (148 mm to 457.2 mm) ^{*1} There are six types of foolcaps: 8-1/2×13-1/2  , 220 mm×330 mm  , 8-1/2×13  , 8-1/4×13  , 8-1/8×13-1/4  , and 8×13  . Any one of these sizes is selectable. For details, contact your service representative.
Power supply	Supply from machine

12.3 Options















Reverse Automatic Document Feeder DF-617

Specifications

Original feed function	1-sided original, 2-sided original, mixed original	
Original types	1-Sided	Plain paper (9-5/16 lb to 55-7/8 lb (35 g/m ² to 210 g/m ²))
	2-sided, mixed original	Plain paper (13-5/16 lb to 34-1/16 lb (50 g/m ² to 128 g/m ²))
Original Size	1-Sided/2-Sided Originals: 11 × 17  to 8.5 × 11  , A3  to B6  , A6  , 8 × 13 	
	For details on handling mixed originals, refer to p. 5-17.	
Original loading capacity	1- or 2-sided original: Max. 100 sheets (21-1/4 lb (80 g/m ²))	
Power supply	Supply from machine	
Max. power consumption	60 W or less	
Size	Width 23-5/8 (600 mm) Depth 22-5/8 (575 mm) Height 5-1/2 (140 mm)	
Weight	Approx. 36-13/16 lb (16.7 kg)	















Paper Feed Cabinet PC-107

Specifications

Paper Type	Plain paper (15-15/16 lb to 23-15/16 lb (60 g/m ² to 90 g/m ²)), Thick 1 (24-3/16 lb to 39-7/8 lb (91 g/m ² to 150 g/m ²)), Thick 2 (40-3/16 lb to 55-5/8 lb (151 g/m ² to 209 g/m ²)), Thick 3 (55-7/8 lb to 68-1/8 lb (210 g/m ² to 256 g/m ²))
Paper Size	11 × 17  to 8.5 × 11  , 5-1/2 × 8-1/2  , A3  to A5  , 8 × 13  ^{*1} , 16K  , 8K  ^{*1} There are six types of foolcaps: 8-1/2×13-1/2  , 220 mm×330 mm  , 8-1/2×13  , 8-1/4×13  , 8-1/8×13-1/4  , and 8×13  . Any one of these sizes is selectable. For details, contact your service representative.
Number of loadable sheets	Tray 3 Plain paper: 500 sheets, Thick 1/Thick 2/Thick 3: 150 sheets
Power supply	Supply from machine
Max. power consumption	15 W or less
Size	Width 23-5/8 (600 mm) Depth 27-3/4 (705 mm) Height 11-3/4 (299 mm)
Weight	Approx. 52-15/16 lb (24 kg)
Unit configuration	Paper tray, 1 level



Paper Feed Cabinet PC-207

Specifications

Paper Type	Plain paper (15-15/16 lb to 23-15/16 lb (60 g/m ² to 90 g/m ²)), Thick 1 (24-3/16 lb to 39-7/8 lb (91 g/m ² to 150 g/m ²)), Thick 2 (40-3/16 lb to 55-5/8 lb (151 g/m ² to 209 g/m ²)), Thick 3 (55-7/8 lb to 68-1/8 lb (210 g/m ² to 256 g/m ²))
Paper Size	11 × 17  to 8.5 × 11  , 5-1/2 × 8-1/2  , A3  to A5  , 8 × 13  ^{*1} , 16K  , 8K  *1 There are six types of foolscap: 8-1/2 × 13-1/2  , 220 mm × 330 mm  , 8-1/2 × 13  , 8-1/4 × 13  , 8-1/8 × 13-1/4  , and 8 × 13  . Any one of these sizes is selectable. For details, contact your service representative.
Number of loadable sheets	Top tray (Tray 3) Plain paper: 500 sheets, Thick 1/Thick 2/Thick 3: 150 sheets Bottom tray (Tray 4) Plain paper: 500 sheets, Thick 1/Thick 2/Thick 3: 150 sheets
Power supply	Supply from machine
Max. power consumption	15 W or less
Size	Width 23-5/8 (600 mm) Depth 27-3/4 (705 mm) Height 11-3/4 (299 mm)
Weight	Approx. 61-3/4 (28 kg)
Unit configuration	Paper tray, 2 levels









































Paper Feed Cabinet PC-408

Specifications

Paper Type	Plain paper (15-15/16 lb to 23-15/16 lb (60 g/m ² to 90 g/m ²)), Thick 1 (24-3/16 lb to 39-7/8 lb (91 g/m ² to 150 g/m ²)), Thick 2 (40-3/16 lb to 55-5/8 lb (151 g/m ² to 209 g/m ²)), Thick 3 (55-7/8 lb to 68-1/8 lb (210 g/m ² to 256 g/m ²))
Paper Size	8.5 × 11  , A4 
Number of loadable sheets	Plain paper: 2500 sheets, Thick 1/Thick 2/Thick 3: 1000 sheets
Power supply	Supply from machine
Max. power consumption	45 W or less
Size	Width 23-5/8 (600 mm) Depth 27-5/8 (702 mm) Height 11-3/4 (299 mm)
Weight	Approx. 61-3/4 (28 kg)

Finisher FS-527

Specifications







Output tray	Output Tray 1, Output Tray 2			
Feeding function	Group, Sort, Offset Group*, Offset Sort*, Staple* * Fed into Output Tray 2			
Paper Type	Group/Sort: Plain paper (15-15/16 lb to 23-15/16 lb (60 g/m ² to 90 g/m ²)) Thick (24-3/16 lb to 79-13/16 lb (91 g/m ² to 300 g/m ²)), Transparency, Postcard, Envelope, Label sheet, Letterhead, Banner paper Offset Group/Offset Sort: Plain paper (15-15/16 lb to 23-15/16 lb (60 g/m ² to 90 g/m ²)), Thick (24-3/16 lb to 79-13/16 lb (91 g/m ² to 300 g/m ²)) Staple: Plain paper (15-15/16 lb to 23-15/16 lb (60 g/m ² to 90 g/m ²)) Thick (24-3/16 lb to 55-5/8 lb (91 g/m ² to 209 g/m ²))			
Paper Size	<p><Output Tray 1> 12-1/4 × 18 , 11 × 17  to 5-1/2 × 8-1/2 , A3  to B6 , A6  Width: 3-9/16 to 12-1/4 (90 mm to 311.15 mm), Length: 5-1/2 to 47-1/4 (139.7 mm to 1200 mm)</p> <p><Output Tray 2> Group/Sort: 12-1/4 × 18 , 11 × 17  to 5-1/2 × 8-1/2 , A3  to B6 , A6  Width: 3-15/16 to 12-1/4 (100 mm to 311.15 mm), Length: 5-1/2 to 18 (139.7 mm to 457.2 mm) Offset Group/Offset Sort: 12-1/4 × 18 , 11 × 17 , 8-1/2 × 11 , A3  to A5  Width: 7-3/16 to 12-1/4 (182 mm to 311.15 mm), Length: 5-7/8 to 18 (148.5 mm to 457.2 mm) Staple: 11 × 17 , 8-1/2 × 14 , 8-1/2 × 11 , A3  to A5  Width: 7-3/16 to 11-11/16 (182 mm to 297 mm), Length: 5-7/8 to 17 (148.5 mm to 431.8 mm)</p>			
Paper loading capacity < Output Tray 1 >	Plain paper (15-15/16 lb to 23-15/16 lb (60 g/m ² to 90 g/m ²))		200 sheets	
	Thick (24-3/16 lb to 79-13/16 lb (91 g/m ² to 300 g/m ²)), Transparency, Envelope, Label sheet, Letterhead		20 sheets	
	Paper loading height: 1-3/8 (35 mm)			
Paper loading capacity < Output Tray 2 >	Group/Sort	Plain paper (15-15/16 lb to 23-15/16 lb (60 g/m ² to 90 g/m ²))	8-1/2 × 11  , A4  or less	3000 sheets
			8-1/2 × 14  , B4  or more	1500 sheets
			5-1/2 × 8-1/2  , A5  or less	500 sheets
		Thick (24-3/16 lb to 79-13/16 lb (91 g/m ² to 300 g/m ²)), Transparency, Envelope, Label sheet, Letterhead		20 sheets
	Offset Group/Offset Sort	Plain paper (15-15/16 lb to 23-15/16 lb (60 g/m ² to 90 g/m ²))	8-1/2 × 11  , A4  or less	3000 sheets
			8-1/2 × 14  , B4  or more	1500 sheets
			5-1/2 × 8-1/2  , A5  or less	500 sheets
	Staple	Plain paper (15-15/16 lb to 23-15/16 lb (60 g/m ² to 90 g/m ²))	2 to 9 sheets: 100 copies* * 8-1/2 × 14  , B4  or more: 50 copies	
			10 to 20 sheets: 50 copies	
			21 to 30 sheets: 30 copies	
31 to 40 sheets: 25 copies				
41 to 50 sheets: 20 copies				
Paper loading height: 14-3/4 (375 mm) (8-1/2 × 11  , A4  or less) / 7-3/8 (187.5 mm) (8-1/2 × 14  , B4  or more)				

Specifications

Maximum number of stapled sheets	Plain paper (15-15/16 lb to 23-15/16 lb (60 g/m ² to 90 g/m ²)): 50 sheets Thick (24-3/16 lb to 31-15/16 lb (91 g/m ² to 120 g/m ²)): 30 sheets Thick (32-3/16 lb to 55-5/8 lb (121 g/m ² to 209 g/m ²)): 15 sheets Example number of stapled sheets: Thick (55-5/8 lb (209 g/m ²)) 2 sheets + Plain paper (23-15/16 lb (90 g/m ²)) 48 sheets
Shift amount	1-3/16 (30 mm)
Power supply	Supply from machine
Max. power consumption	56 W or less
Size	Width 20-13/16 (528 mm), 25-7/8* (658 mm*) Depth 25-1/4 (641 mm) Height 40-3/8 (1025 mm), 42-13/16* (1087 mm*) * Size when the tray is pulled out
Weight	Approx. 92-9/16 lb (42 kg)
Consumables	Staple SK-602 For EH-590 (Product No. 505 manufactured by MAX) (5000 staples included) × 1 unit









Saddle Stitcher SD-509

Specifications

Feeding function	Center Staple & Fold, Half-Fold		
Paper Type	Plain paper (15-15/16 lb to 23-15/16 lb (60 g/m ² to 90 g/m ²)) Thick (24-3/16 lb to 55-5/8 lb (91 g/m ² to 209 g/m ²))* * Can be used only as a cover page.		
Paper Size	12-1/4 × 18  , 11 × 17  , 8-1/2 × 14  , 8-1/2 × 11  , A3  , B4  , A4  Width: 8-1/4 to 12-1/4 (210 mm to 311.15 mm), Length: 11 to 18 (279.4 mm to 457.2 mm)		
Maximum number of sheets that can be center-stapled	15 sheets • 14 sheets (15-15/16 lb to 23-15/16 lb (60 g/m ² to 90 g/m ²)) + 1 sheet (15-15/16 lb to 55-5/8 lb (60 g/m ² to 209 g/m ²))		
Maximum number of folded sheets	3 sheets		
Capacity of Folding Output Tray	Number of stapled and folded sheets	1 to 3 sheets	20 copies
		4 to 10 sheets	10 copies
		11 to 15 sheets	5 copies
Size	Width 9-7/16 (239 mm) Depth 22-13/16 (579 mm) Height 21 (534 mm)		
Weight	Approx. 52-15/16 lb (24 kg)		
Consumables	Staple SK-602 For EH-280 (Product No. 505 manufactured by MAX) (5000 staples included) × 2 unit		
Power supply	Supplied from Finisher FS-527 .		





Punch Kit PK-517

Specifications

Number of punch holes	2 holes, 3 holes, 4 holes		
Paper Type	Plain paper (15-15/16 lb to 23-15/16 lb (60 g/m ² to 90 g/m ²)), Thick (24-3/16 lb to 68-1/8 lb (91 g/m ² to 256 g/m ²))		
Paper Size	2 holes	11 × 17  to 8-1/2 × 11  	
	3 holes	11 × 17  to 8-1/2 × 11 	
	4 holes	A3  to A4  , B5 	
Power supply	Supplied from Finisher FS-527 .		
Size	Width 2-5/16 (58 mm) Depth 18-1/2 (470 mm) Height 5-5/16 (135 mm)		
Weight	Approx. 3-15/16 lb (1.8 kg)		

Separator JS-603

Specifications















Output tray	Output Tray 3
Feeding function	Group, Sort
Paper Type	Plain paper (15-15/16 lb to 23-15/16 lb (60 g/m ² to 90 g/m ²), Thick (24-3/16 lb to 68-1/8 lb (91 g/m ² to 256 g/m ²), Transparency, Envelope, Label sheet, Letterhead
Paper Size	12-1/4 × 18  , 11 × 17  to 5-1/2 × 8-1/2  , A3  to A5 
Paper loading quality	Plain paper (15-15/16 lb to 23-15/16 lb (60 g/m ² to 90 g/m ²): 100 sheets, Thick (24-3/16 lb to 79-13/16 lb (91 g/m ² to 300 g/m ²), Transparency, Envelope, Label sheet, or Letterhead: 10 sheets
	Paper loading height: 7/8 (22 mm)
Size	Width 6-1/2 (165 mm) Depth 15-5/16 (389 mm) Height 2-1/2 (63 mm)
Weight	Approx. 2-3/16 (1 kg)

Finisher FS-529

Specifications

Output tray	Output Tray 1 (Elevate tray)			
Feeding function	Group, Sort, Offset Group, Offset Sort, Staple			
Paper Type	<p>Group/Sort: Plain paper (15-15/16 lb to 23-15/16 lb (60 g/m² to 90 g/m²)), Thick (24-3/16 lb to 72-1/16 lb (91 g/m² to 271 g/m²)), Transparency, Envelope, Label sheet, Letterhead, Banner paper</p> <p>Offset Group/Offset Sort: Plain paper (15-15/16 lb to 23-15/16 lb (60 g/m² to 90 g/m²)), Thick (24-3/16 lb to 55-5/8 lb (91 g/m² to 209 g/m²))</p> <p>Staple: Plain paper (15-15/16 lb to 23-15/16 lb (60 g/m² to 90 g/m²)), Thick (24-3/16 lb to 55-5/8 lb (91 g/m² to 209 g/m²))*</p> <p>* Can be used only as a cover page.</p>			
Paper Size	<p>Group/Sort: 12-1/4 × 18 □, 11 × 17 □ to 5-1/2 × 8-1/2 □/□, A3 □ to B6 □, A6 □ Width: 3-9/16 to 12-1/4 (90 mm to 311.15 mm), Length: 5-1/2 to 47-1/4 (139.7 mm to 1200 mm)</p> <p>Offset Group/Offset Sort/Staple: 11 × 17 □ to 8-1/2 × 11 □/□, A3 □ to B5 □ Width: 8-1/4 to 11-11/16 (210 to 297 mm), Length: 7-3/16 to 17 (182 mm to 431.8 mm)</p>			
Paper loading quality	Group/Sort	Plain paper (15-15/16 lb to 23-15/16 lb (60 g/m ² to 90 g/m ²))	8-1/2 × 11 □, A4 □ or less	300 sheets
			8-1/2 × 14 □, B4 □ or more	250 sheets
		Thick (24-3/16 lb to 72-1/16 lb (91 g/m ² to 271 g/m ²)), Transparency, Envelope, Label sheet, Letterhead	10 sheets	
	Offset Group/Offset Sort	Plain paper (15-15/16 lb to 23-15/16 lb (60 g/m ² to 90 g/m ²))	8-1/2 × 11 □, A4 □ or less	300 sheets
			8-1/2 × 14 □, B4 □ or more	250 sheets
		Thick (24-3/16 lb to 55-5/8 lb (91 g/m ² to 209 g/m ²))	10 sheets	
	Staple	Plain paper (15-15/16 lb to 23-15/16 lb (60 g/m ² to 90 g/m ²))	8-1/2 × 11 □, A4 □ or less	300 sheets or 30 copies
			8-1/2 × 14 □, B4 □ or more	250 sheets or 30 copies
	Paper loading height: 1-7/16 (37 mm)			
Maximum number of stapled sheets	8-1/2 × 11 □, A4 □ or less		50 sheets	
	8-1/2 × 14 □, B4 □ or more		30 sheets	
	<p>Example number of stapled sheets: Thick (55-5/8 lb (209 g/m²)) 2 sheets + Plain paper (23-15/16 lb (90 g/m²)) 48 sheets*</p> <p>* 8-1/2 × 14 □, B4 □ or more: 28 sheets</p>			
Shift amount	1-3/16 (30 mm)			
Power supply	Supply from machine			
Max. power consumption	56 W or less			
Size	<p>Width 18-9/16 (471 mm), 25-3/4* (654 mm*)</p> <p>Depth 22-3/16 (564 mm)</p> <p>Height 5-13/16 (147 mm)</p> <p>* Size when the tray is pulled out</p>			
Weight	Approx. 26-7/16 (12 kg)			
Consumables	<p>Staple SK-602</p> <p>For EH-590 (Product No. 505 manufactured by MAX) (5000 staples included) × 1 unit</p>			

Job Separator JS-505

Specifications	
Output tray	Output Tray 1, Output Tray 2
Feeding function	Group, Sort, Offset Group, Offset Sort
Paper Type	<p><Output Tray 1> Plain paper (15-15/16 lb to 23-15/16 lb (60 g/m² to 90 g/m²))</p> <p><Output Tray 2> Plain paper (15-15/16 lb to 23-15/16 lb (60 g/m² to 90 g/m²)), Thick (24-3/16 lb to 71-5/16 lb (91 g/m² to 268 g/m²)), Transparency, Postcard, Envelope, Label sheet, Banner paper</p>
Paper Size	<p><Output Tray 1> 11 × 17  to 8-1/2 × 11 , A3  to A5  Width: 5-13/16 to 11-11/16 (148 mm to 297 mm), Length 8-1/4 to 17 (210 mm to 431.8 mm)</p> <p><Output Tray 2> 12-1/4 × 18 , 11 × 17  to 5-1/2 × 8-1/2 , A3  to B6 , A6 , Postcard  Width: 3-9/16 to 12-1/4 (90 mm to 311.1 mm), Length: 5-1/2 to 47-1/4 (139.7 mm to 1200 mm)</p>
Paper loading quality	<p><Output Tray 1> Plain paper (15-15/16 lb to 23-15/16 lb (60 g/m² to 90 g/m²)): 50 sheets Paper loading height: 9/16 (14.5 mm)</p> <p><Output Tray 2> Plain paper (15-15/16 lb to 23-15/16 lb (60 g/m² to 90 g/m²)): 150 sheets Thick (24-3/16 lb to 71-5/16 lb (91 g/m² to 268 g/m²)), Transparency, Postcard, Label sheet: 20 sheets, Envelope: 10 sheets, Banner paper: 1 sheet Paper loading height: 1-1/16 (27.6 mm)</p>
Power supply	Supply from machine
Max. power consumption	40 W or less
Shift amount	1-3/16 (30 mm)
Offset function	<p><Output Tray 2> 11 × 17  to 5-1/2 × 11 , A3  to B5 </p>
Size	<p>Width 16-5/8 (423 mm), 21-3/8[*] (543 mm[*]) Depth 18-3/4 (477 mm) Height 5-1/8 (129.5 mm) [*] Size when the tray is pulled out</p>
Weight	Approx. 11 lb (5 kg)

Authentication Unit (biometric type) AU-101

Specifications		
Name	AU-101	
Applied finger width	3/8 (10 mm) to 1 (25 mm)	
Interface	USB 2.0	
Dimensions	Width 3-1/16 (78 mm) Depth 3-3/4 (95 mm) Height 2-3/16 (55 mm)	
Weight	Approx. 5/16 lb (Approx. 150 g) (excluding USB cable)	
Max. power consumption (mA)	DC 5 V 500 mA	
System conditions (during operation)	Ambient temperature	50 °F to 95 °F (10 °C to 35 °C)
	Humidity	10% to 80% (No dew condensation)
System conditions (during non-operation)	Ambient temperature	14 °F to 140 °F (-10 °C to 60 °C)
	Humidity	10% to 80% (No dew condensation)

Specifications

Compatible computer	CPU	PC/AT compatible, 1 GHz or more
	Memory	128 MB or more
	HDD	100 MB or more
	Monitor	800 × 600 pixels, 16-bit color or more
	Network	TCP/IP
	Application	Microsoft Internet Explorer 6.0 (SP1) or later Microsoft .NET Framework (SP1) or later
	Interface	USB 1.1 or later
Supported Operating Systems		Windows 2000 Professional (SP4) Windows XP Professional Edition (SP2) Windows Vista Business/Enterprise

Authentication Unit (biometric type) AU-102**Specifications**

Name	AU-102	
Biometric sensor system	Transmission-type optical system	
Verification time	Approx. 1 sec. or less	
Interface	USB 2.0	
Dimensions	Width 2-5/16 (59 mm) Depth 3-1/4 (82 mm) Height 2-15/16 (74 mm)	
Weight	Approx. 3/16 lb (Approx. 96 g) (excluding USB cable)	
Max. power consumption (mA)	DC 5 V 500 mA	
System conditions (during operation)	Ambient temperature	41 °F to 95 °F (5 °C to 35 °C)
	Humidity	20% to 80% (No dew condensation)
System conditions (during non-operation)	Ambient temperature	32 °F to 122 °F (0 °C to 50 °C)
	Humidity	20% to 80% (No dew condensation)
Compatible computer	CPU	PC/AT compatible, 1 GHz or more
	Memory	128 MB or more
	HDD	100 MB or more
	Monitor	800 × 600 pixels, 16-bit color or more
	Network	TCP/IP
	Application	Microsoft Internet Explorer 6.0 (SP1) or later Microsoft .NET Framework (SP1) or later
	Interface	USB 1.1 or later
Supported Operating Systems		Windows 2000 Professional (SP4) Windows XP Professional Edition (SP2) Windows Vista Business/Enterprise

Authentication Unit (IC card type) AU-201

Specifications

Name		AU-201
Dimensions		Width 3-5/8 (92 mm) Depth 2-1/2 (64 mm) Height: 5/8 (16 mm)
Weight		Approx. 1/4 lb (Approx. 120 g)
Power supply		Power received from USB port
System conditions (during operation)	Ambient temperature	32 °F to 104 °F (0 °C to 40 °C)
	Humidity	20% to 85% (No dew condensation)
System conditions (during non-operation)	Ambient temperature	-4 °F to 122 °F (-20 °C to 50 °C)
	Humidity	20% to 85% (No dew condensation)
Radio law division		Self-guided read-write communication facility
Applicable card		ISO 14443 Type A, FeliCa-based noncontact IC card, HID iClass
Acquired standard		VCCI class B
Compatible computer	CPU	PC/AT compatible, 1 GHz or more
	Memory	128 MB or more
	HDD	Free space: 100 MB or more
	Monitor	800 × 600 pixels, 16-bit color or more
	Network	TCP/IP
	Application	Microsoft Internet Explorer 6.0 (SP1) or later Microsoft .NET Framework (SP1) or later
	Interface	USB 1.1 or later
Supported Operating Systems		Windows 2000 Professional (SP4) Windows XP Professional Edition (SP2) Windows Vista Business/Enterprise

13

Appendix

13 Appendix

13.1 Colors

[Hue], [Brightness], and [Saturation]

Color has three elements: hue, brightness, and saturation. These are referred to as three attributes of colors and all colors are created by combinations these elements.

You can adjust the hue, brightness, and saturation in 19 levels.

What is hue?

Everybody has an idea of what "hue" an object has, for example, an apple is red, a lemon is yellow, and the sky is blue. "Hue" is the tint by which the color of an object is classified as red, yellow, blue, etc.

What is brightness?

"Brightness" is the degree of lightness in a color, as compared with another color, which makes it a light color or a dark color. For example, when comparing the yellow of a lemon and the yellow of a grapefruit, it is obvious that the yellow of the lemon is brighter. But what about when comparing the yellow of a lemon and the red of a bean? Obviously, the yellow of the lemon is brighter. "Brightness" is this degree of lightness that enables comparison regardless of the hue.

What is saturation?

What makes the difference between the yellow of a lemon and the yellow of a pear? By saying that the lemon is a more vivid yellow and the pear is a duller yellow, the difference between the two colors is stated in terms of "saturation", as opposed to "brightness". As opposed to hue and brightness, "saturation" is the characteristic that indicates the degree of vividness.

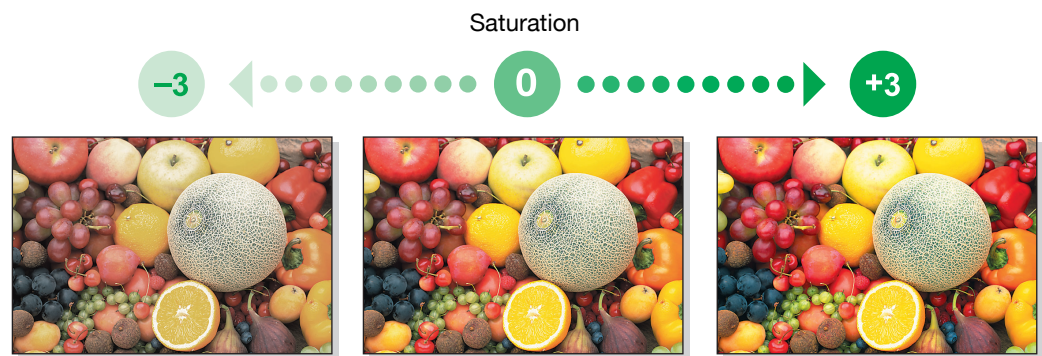
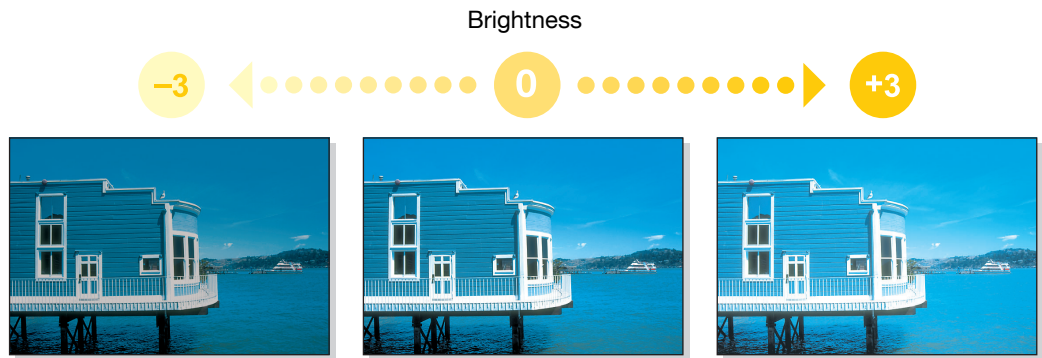
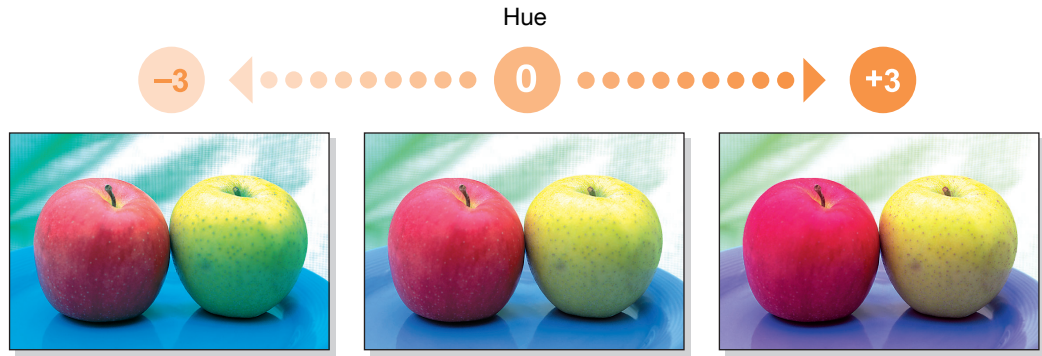

[Red], [Green], and [Blue]

This machine allows you to adjust red, green, and blue in 19 levels.

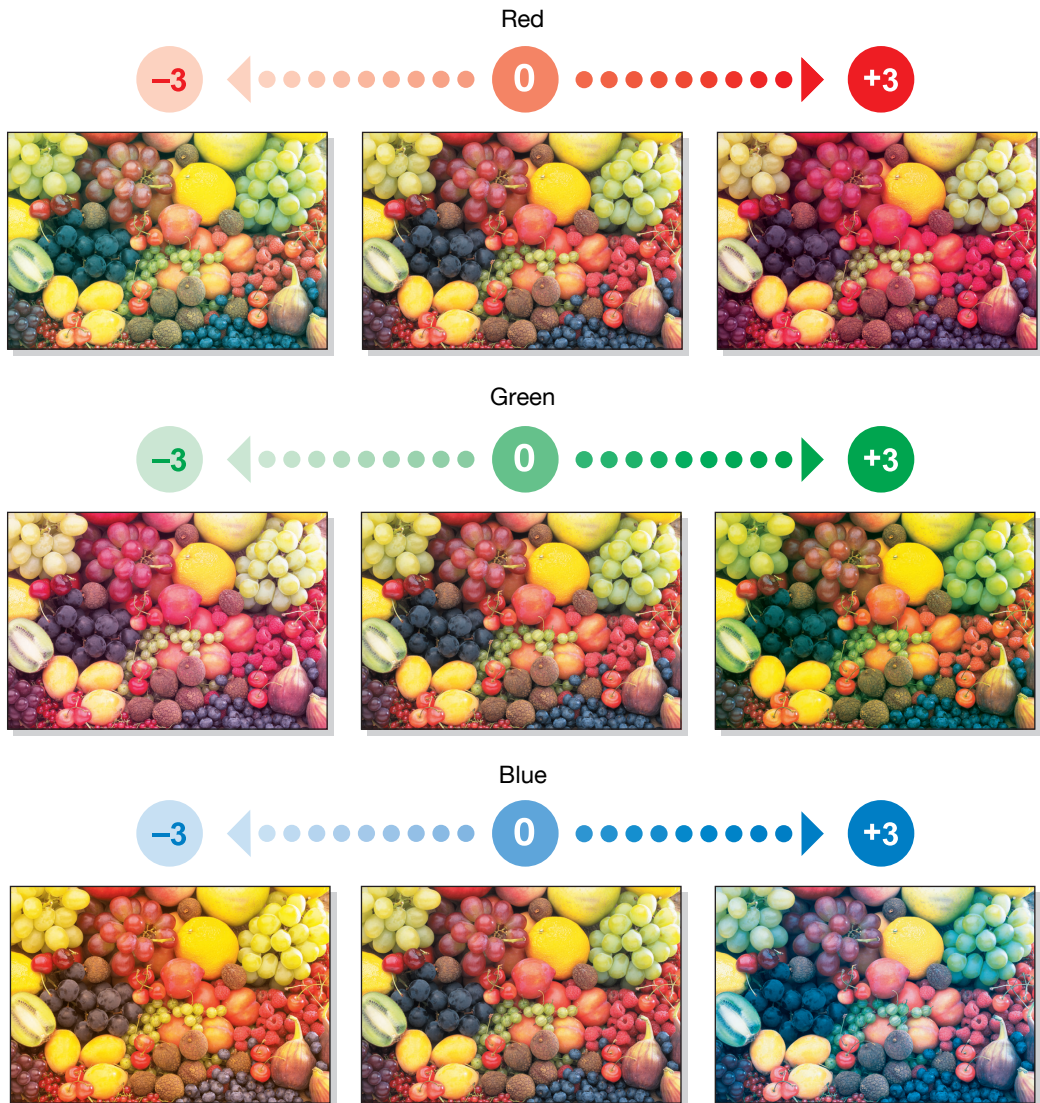

13.2 Image quality

[Contrast], [Copy Density], and [Sharpness]

[Contrast]:

You can finely adjust an image in between soft/smooth and crisp.

[Copy Density]:

You can finely adjust the shading of an image.

[Sharpness]:

You can adjust the amount of contours in text and images.

You can adjust the contrast and copy density in 19 levels and the sharpness in 7 levels.

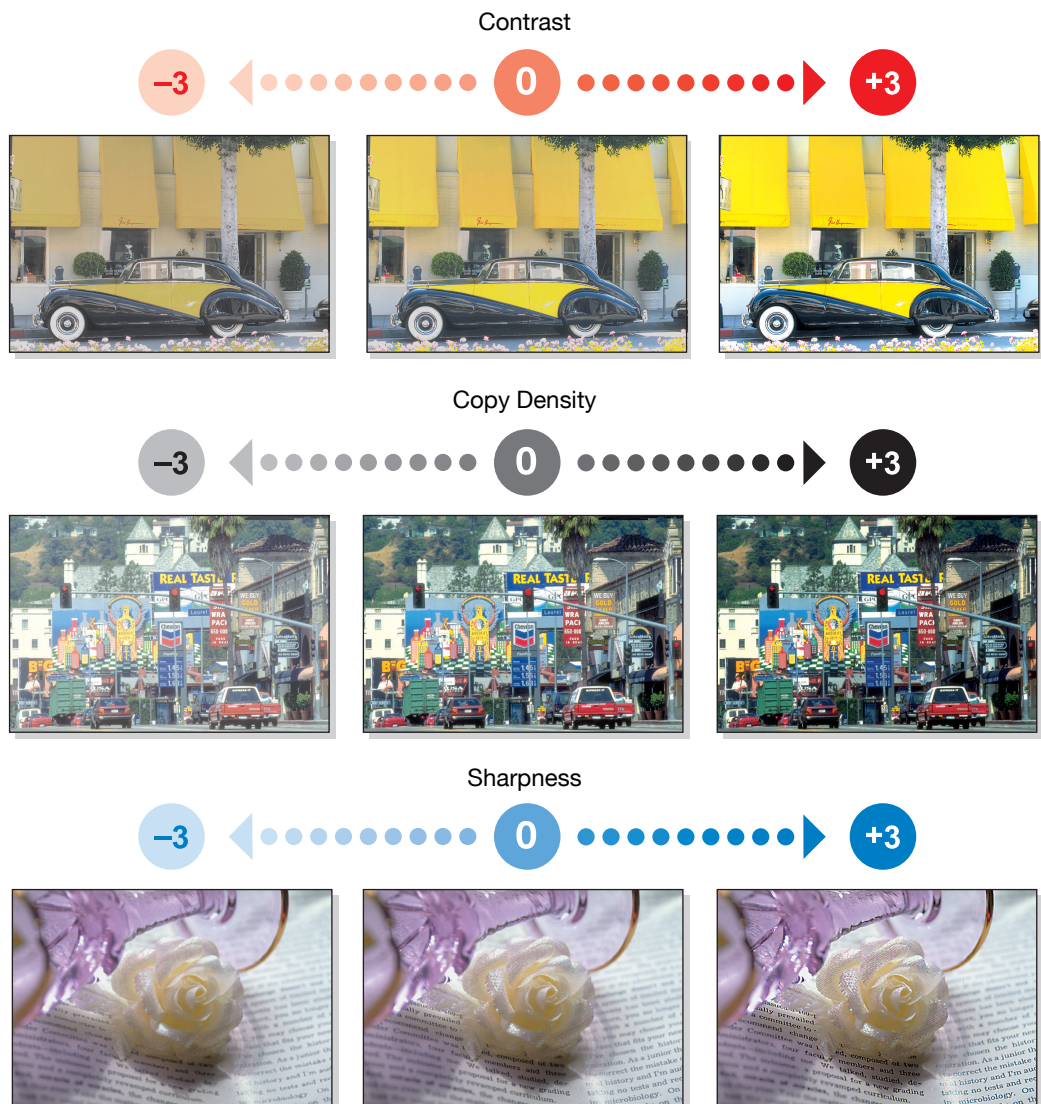

[Color Balance] (CMYK)

Full-color copy reproduces colors of the original by mixing toners of four colors: yellow, magenta, cyan, and black. By changing the amount of each of the four toners, adjust the tints in the copy.

You can adjust the color balance in 19 levels.

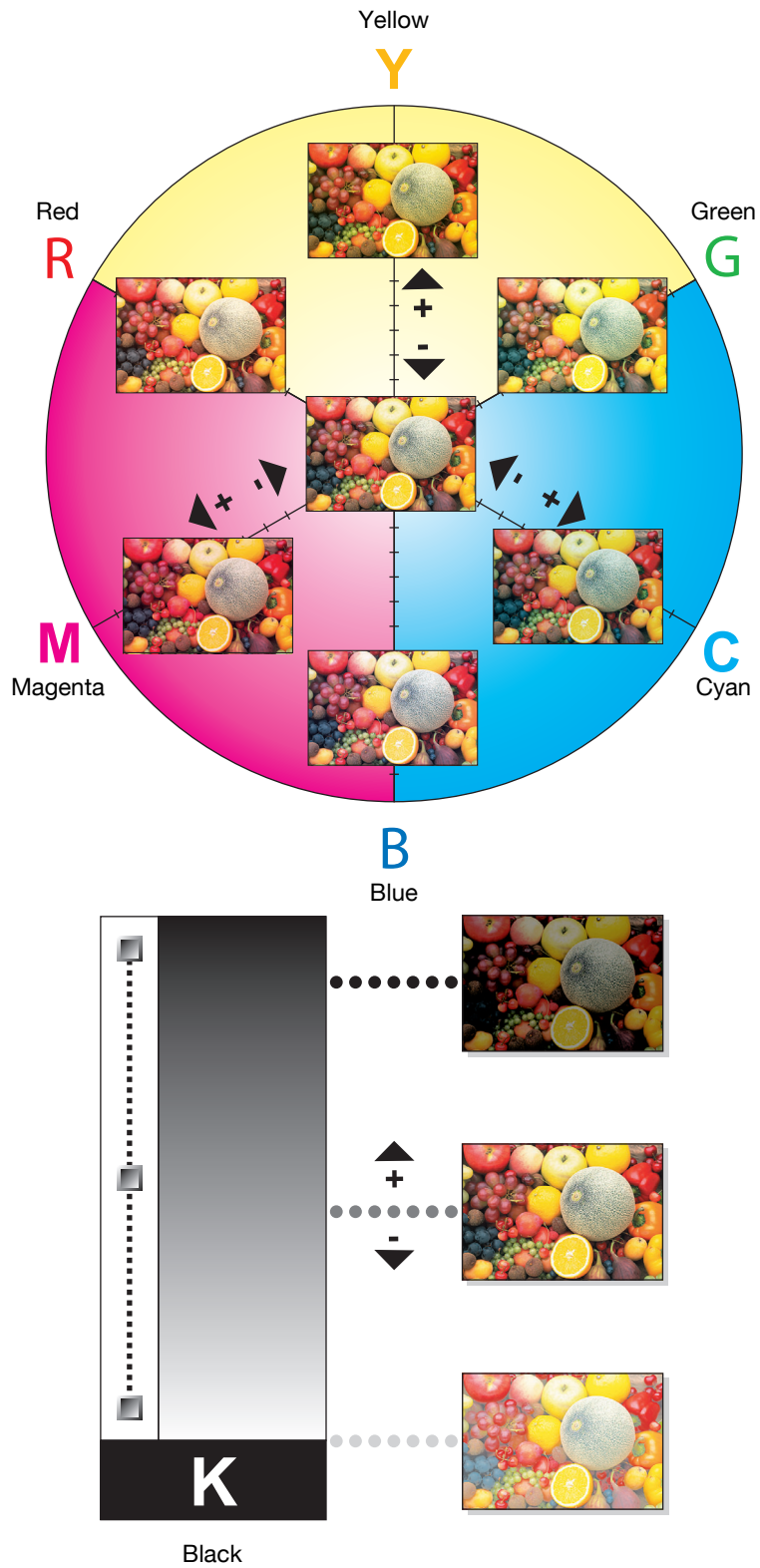

13.3 Glossary

The following describes the terms used in Copy mode.

Term	Description
ADF	The acronym for Reverse Automatic Document Feeder . It can automatically scan originals. (ADF = Automatic document feeder)
[AE Level Adjustment]	Function that adjusts the background of the original. The higher the setting, the more that the document background is emphasized. (AE = Auto Exposure)
APS	The acronym for Auto Paper Select. (APS = Auto Paper Select)
ATS	Function that automatically switches trays. (ATS=Auto Tray Switch)
Auto Paper	Function that detects the size of the original placed on the Original Glass or loaded into the ADF , and automatically selects paper of the same size if it is set to Full Size or selects the paper size appropriate to the specified zoom ratio.
Auto Zoom	Function that automatically selects the appropriate zoom ratio when you place an original in the ADF or on the Original Glass , and selects the paper size.
[Background Color]	Function that copies the original using one of the 18 colors available for the background color (blank areas).
[Background Removal]	Function that adjusts the background density of the original with a colored background. Select a background removal method and level to copy the original.
[Binding Position]	Function that allows you to specify the position of the page margin in one side of the loaded original. Selecting the appropriate setting prevents the copy from being printed upside-down when making a 2-sided copy from a 1-sided original or when making a 1-sided copy from a 2-sided original.
[Blue]	Function that adjusts the level of blue in the image, for example, if you wish to emphasize the blue of water or the sky.
[Brightness]	Function that makes the image either lighter or darker.
[Card Shot]	Separately scans the contents of the front and back sides of a card, for example, insurance card, driver's license, or business card, and copies them together on one sheet. You can copy a card with the full size or enlarge an image to fit paper. Using the card copy function, you can save the number of sheets to be used.
[Center Staple & Fold]	Function that folds the copies in half and staples them together in the center.
[Change Tray Settings]	Function that copies the original with a paper size not specified in the paper tray or copies it on paper other than plain paper.
[Color Adjust]	Function that adjusts the color copy image quality to match the original image.
[Color Balance]	Function that adjusts the balance in the concentration for each of cyan (C), magenta (M), yellow (Y) and black (K). You can finely adjust the individual color balance in 19 levels between -3 and +3.
[Color]	Function that copies the original in specified colors. Using the 2 Color function, you can copy in two colors: specified color and black.
Combine Originals	Function that arranges reduced copies of multiple original pages on a single copy page. You can select , "2in1", "4in1", or "8in1" depending on the number of pages to be combined.
[Contrast]	Function that adjusts the contrast between light and dark.
[Copy Density]	Function that allows you to finely adjust the copy density in 19 levels between -3 and +3.
[Copy Guard]	To prevent unauthorized copying, this function prints a text such as Copy or Private or information such as Date/Time on all pages of paper as a copy guard (copy inhibit information) when copying. You cannot copy a page with a copy guard printed.
[Copy Protect]	Function that prints hidden text to prevent unauthorized copying. Copying a copy-protected document repeatedly prints hidden text in all pages more clearly than the original to prove the user that it is a copied document.
[Cover Sheet]	Function that attaches a sheet in the specified paper tray as a cover page.
[Density]	Function that adjusts the density of the print image in nine levels.

Term	Description
[Duplex 2nd Side]	Function to use when copying on paper that has already been printed on one side.
[Duplex/Combine]	Function to specify the scanning side of the original and the printing side of the paper to be 1-sided or 2-sided.
[Edit Color]	Function that configures the image according to the objectives of copy editing.
[Finishing]	Allows you to select how to sort or finish copies when feeding them into the output tray.
Finishing Preview	Function that allows you to check the finishing status with a preview image before printing.
[Finishing Program]	Allows you to select a preset offset or finishing method.
[Glossy]	Function that improves the glossy level of an image.
[Green]	Function that adjusts the level of green in the image, for example, if you wish to emphasize the green of forests and trees.
Group (Access permission)	Function that limits the addresses that can be accessed by each user in order to assure security.
Group (Copy or Finishing)	Function that prints copies in pages. This function first prints the specified number of copies of the first page, and then prints the second page in the same way.
[Half-Fold]	Function that folds printed paper in half.
[Hue]	Function that adjusts the hue level to make the image either more reddish or more bluish.
[Manual]	Function that enlarges or reduces the loaded original with the zoom ratio specified using the keypad, and copies it on paper.
[Minimal]	This setting slightly reduces the image of the original and copies it at the center of the paper.
[Mirror Image]	Function that produces a copy in the mirror image of the original.
[Mixed Original]	Function that detects the size of each original page and prints a copy on paper of the appropriate size when loading originals in different page sizes into the Reverse Automatic Document Feeder .
[Neg./Pos. Reverse]	Function that copies the original with the light- and dark-colored areas or the colors (gradations) of the image reversed.
[Offset]	Function that sorts copies.
[OHP Interleave]	Function that inserts a blank sheet between transparency films each time a transparency film is copied. This function prevents transparency films from sticking together.
[Original Direction]	Function that specifies the orientation of the original loaded into the ADF or placed on the Original Glass .
[Original Type]	Function that allows you to select the desired functions according to the original text or image type and adjust it to obtain better image quality.
[Paper]	Allows you to configure the type and the size of the paper to be printed on.
[Password Copy]	To prevent unauthorized copying, this function prints a text such as Copy or Private or information such as Date/Time on all pages of paper as a password when copying. When a sheet of paper with a password embedded is copied, the currently running job is suspended, and the password entry screen is displayed. In this case, enter the password to copy data.
Proof Copy	Function that prints a sample copy and stops printing temporarily before printing a large number of copies. This prevents copy errors from occurring in a large number of copies.
[Punch]	Function that punches copies for filing.
[Red]	Function that adjusts the level of red in the image, for example, if you wish to red- den skin tones.
[Saturation]	That adjusts the degree of vividness of the colors in the image.
[Save in User Box]	Function that temporarily saves the job on the hard disk so that it can be recalled later and used again.

Term	Description
[Separate Scan]	Function that divides the original into multiple parts for scanning when the number of original pages exceeds the maximum (100 pages) that can be loaded into the ADF . You can scan the original and batch-copies it as one copy job. You can also load the original on the Original Glass or switch to the ADF during scanning.
[Sharpness]	Function that emphasizes the edges of text so that it can be read more easily. This function also enables you to adjust the original image.
[Sheet/Cover/Chapter Insert]	Allows you to configure editing functions according to your copying requirement.
Sort	Function that prints a document in sets of copies. The second copy set is printed after all of the first copy set is finished.
[Staple]	Function that staples copies.
[Text Enhancement]	Function that allows you to configure the reproduction quality of the text when copying originals consisting of text that overlaps images such as illustrations or graphs (text with a background).
[Zoom]	Function that changes the zoom ratio of the copy.

14

Index

14 Index

14.1 Index by item

A

Access 4-9
 Accessibility 4-13
 Account track 4-9
 Account track settings 7-33
 Adjust the paper alignment plate position 7-16
 Adjusting gradation 7-17
 Adjusting the center staple position 7-14
 Adjusting the half-fold position 7-15
 Adjusting the punch horizontal position 7-15
 Adjusting the punch resistance loop 7-16
 Administrator password 7-46
 Administrator security levels 7-47
 Administrator settings 7-3
 Administrator/machine settings 7-25
 Advanced preview 4-20
 Application settings 5-22
 Authentication device settings 7-37
 Authentication method 7-27, 7-37
 Authentication unit 2-3
 Authentication unit (biometric type) 10-3, 12-15, 12-16
 Authentication unit (IC card type) 11-3, 12-17
 Automatic duplex unit 2-10, 12-7

B

Background color 5-32
 Basic tab 2-13
 Biometric type 10-3
 Blank page print settings 7-22
 Blue 13-5
 Book copy 5-35
 Book copy/repeat 5-35
 Booklet 5-43
 Booklet original 5-39
 Bottom right door 2-6
 Bottom right door release lever 2-6
 Brightness 13-3
 Brightness adjustment dial 2-11
 Bypass tray 2-6

C

C 4-18
 Card copy 5-60
 Cellular phone/PDA setting 6-18
 Centering 7-13
 Centering (duplex 2nd side) 7-13
 Changing e-mail addresses 6-14
 Changing icons 6-15

Changing passwords 6-13
 Charger-cleaning tool 2-10
 4-8
 Checking consumables 8-8
 Checking job settings 2-13, 5-65
 Checking the total number of pages printed 8-13
 Cleaning procedure 8-14
 CMYK 13-7
 Color 5-5
 Color adjustment 5-33
 Color balance 13-7
 Color registration adjustment 7-16
 Colors 13-3
 Configuring the basic settings 5-4
 Contrast 13-6
 Control panel 2-6, 2-11, 4-3, 8-14
 Copier settings 6-9, 7-40
 Copy density 13-6
 Copy function 5-3
 Copy guard 5-51
 Copy protection 5-50
 Copying 4-6
 Copying mixed originals 5-17
 Cover sheet 5-24
 Coverage rate 8-11
 Custom display settings 6-7
 Custom size 5-7

D

Data indicator 2-11
 Date/time 5-46
 Date/time settings 7-6
 Daylight saving time 7-6
 Dedicated desk 2-3
 Default bypass paper type setting 7-23
 Driver password encryption setting 7-55
 Drum unit 2-10
 Duplex/combine 5-9

E

Editing colors 5-30
 Editing pages 5-23
 Eject assist lever 2-18
 Electrostatic charger wire 9-13
 Enhanced security mode 7-51
 Enlarge display 4-15
 Erasing 5-44
 Erasing frames 5-44
 Erasing non-image areas 5-45

Expert adjustment *7-10*
 External server settings *7-36*

F

Fax kit *2-3*
 Fax settings *7-43*
 Fax/scan *4-6*
 Fax/scan settings *6-11*
 Finisher *2-3, 12-10, 12-14*
 Finisher FS-527 *2-15*
 Finisher FS-529 *2-17*
 Finishing *5-12*
 Fold/bind *5-13*
 Folding output tray *2-15*
 Front door *2-6, 2-15*
 Function keys *2-11*
 Function management settings *7-54*
 Functions/settings display area *2-13*
 Fusing cover lever *2-10*
 Fusing unit *2-10*
 Fusing unit top cover *2-10*

G

Green *13-5*
 Grouping *5-12*
 Guidance *4-16*
 Guide lever *2-15*

H

Handle *2-15*
 HDD settings *7-53*
 Header/footer *5-55*
 Horizontal transport unit cover *2-15*
 Housing *8-15*
 Hue *13-3*

I

IC card type *11-3*
 Icon display area *2-13*
 Icons *9-12*
 Image adjustment *5-41*
 Image controller *2-3*
 Image quality *13-6*
 Image repeat *5-37*
 Inserting images *5-26*
 Inserting sheets *5-25*
 Inside of the main body *2-10*
 Interleaving OHP transparencies *5-23*
 Interrupt *4-5*

J

Jack for connecting a telephone (TEL PORT1) *2-8*
 Jack for connecting a telephone (TEL PORT2) *2-8*
 Jam removal dial *2-11, 2-16, 2-17, 2-18*
 Job list *2-13*
 Job separator *2-15*
 Job separator JS-505 *2-18*
 Job separator JS-603 *2-15*

K

Keyboard holder *2-4*
 Keypad *2-11*

L

Lateral guides *2-6*
 LCT *2-6, 8-5*
 Leading edge adjustment *7-13*
 Leading edge adjustment (duplex side 2) *7-13*
 Left cover *2-6*
 Left cover release lever *2-6*
 Left panel *2-13, 5-62*
 License settings *7-56*
 Limiting access to destinations *7-36*
 List/counter *7-18*
 Listing jobs *5-63*
 Loading paper *8-4*
 Loading paper into the bypass tray *8-6*
 Local interface kit *2-3*
 Lock release knob *2-10*

M

Machine specifications *12-5*
 Main power switch *2-10*
 Maintenance *8-3*
 Media adjustment *7-14*
 Message display area *2-13*
 Meter count *8-11*
 Mirror image *5-31*
 Mode memory *4-8*
 Mount kit *2-3, 2-5*

N

Negative-positive reversal *5-30*
 Network connector *2-8*
 Network settings *7-39*

O

Offsetting *5-12*
 One-touch/user box registration *7-26*
 OpenAPI authentication management settings *7-57*
 Options *2-3, 12-8*
 Original glass *2-10, 8-14*
 Original glass cleaner *2-10*
 Original output tray *2-6*
 Original pad *2-6, 8-15*
 Original scales *2-10*
 Original setting *5-16*
 Original tray *2-6*
 Output settings *7-5*
 Output tray *2-6, 2-17*
 Output tray 1 *2-15, 2-18*
 Output tray 2 *2-15, 2-18*
 Outside of main body (Front) *2-6*
 Outside of the main body (rear) *2-8*
 Overlay *5-57*
 Overlaying registered images *5-58*

Ozone filter *2-9*

P

Page margin *5-40*

Page number *5-47*

Page number print position settings *7-24*

Paper *5-6, 8-3, 12-3*

Paper cabinet *2-3, 12-8, 12-9*

Paper capacities *12-3*

Paper types *12-3*

Paper-empty indicator *2-6*

Password *5-52*

Placing originals *3-5*

Poster mode *5-38*

Power cord *2-8*

Power indicator *2-11*

Power save *4-12*

Power save settings *7-4*

Print head *9-14*

Print head glass cleaning tool *2-10*

Print without authentication *7-35*

Printer settings *6-12, 7-42*

Printing counter list *7-35*

Program jobs *5-28*

Proof copy *4-19*

Punch *5-13*

Punch kit *2-3, 2-15, 12-12*

Punch kit PK-517 *2-15*

Punch scrap box *2-16*

Q

Quality/density *5-19*

Quick copy tab *2-13, 2-14*

R

Red *13-5*

Register auth. info. *6-16*

Register authentication information *6-16*

Registering one-touch destinations or user boxes *7-26*

Replacement message *8-8*

Replenishment message *8-3*

Reset *4-5*

Reset settings *7-19*

Restricting user accesses *7-8*

Reverse automatic document feeder *12-8*

S

Saddle stitcher *2-3, 2-15, 12-12*

Saddle stitcher SD-509 *2-15*

Saturation *13-3*

Save in user box *5-61*

Saving in user boxes *5-61*

Scan to authorized folder settings *7-38*

Scan to home settings *7-38*

Security details *7-48*

Security kit *2-3*

Security settings *7-46*

Separate scan *5-14*

Separating chapters *5-27*

Separator *2-3, 12-15*

Service call *9-3*

Settings common to user and account track authentication *7-38*

Sharpness *13-6*

Skip job operation settings *7-22*

Sorting *5-12*

Specifications *12-3*

Stamp *5-49*

Stamp repetition *5-53*

Stamp settings *7-21, 7-55*

Stamp unit *2-3*

Stamp/composition *5-46*

Staple cartridge *2-15*

Stapling *5-12*

Start *4-5*

Status indicator *2-6*

Stop *4-5*

Storage box *2-6*

Stylus pen *2-11*

Sub power switch *2-6, 2-11*

System connection *7-44*

System settings *6-4, 7-4*

T

Take-up roller *8-14*

Telephone jack 2 (LINE PORT2) *2-8*

Toner cartridge *2-10*

Toner supply indicators *2-13*

Top right door *2-6*

Top right door release lever *2-6*

Total counter *2-10*

Touch panel *2-11, 2-13*

Tray 1 *2-6, 8-4*

Tray 2 *2-6, 8-4*

Tray 3 *2-6, 8-4*

Tray 4 *2-6, 8-4*

Tray extension *2-17, 2-18*

Tray release button *2-6*

Troubleshooting *9-3*

Troubleshooting table *9-5*

Turning off automatic rotation *5-15*

U

USB port (type A) USB2.0/1.1 *2-6, 2-8*

USB port (type A) USB2.0/1.1 (For compact keyboard) *2-6*

USB port (type B) USB2.0/1.1 *2-8*

User authentication *4-9*

User authentication settings *7-30*

User authentication/account track *7-27*

User box *4-6*

User box administrator setting *7-46*

User box settings *7-20*

User settings *6-3*

Utility/counter *4-7*

V

Video interface kit *2-3*

W

Waste toner box *2-10*

Watermark *5-56*

Weekly timer setting *7-7*

Wide paper *5-7*

Working table *2-3*

Z

Z-folded original *5-18*

Zoom *5-8*

14.2 Index by button

Numerics

1-Sided > 1-Sided *5-9*
 1-Sided > 2-Sided *5-9*
 2 Color *5-5*
 2/4/8 Repeat *5-37*
 2in1 *5-10*
 2-Sided > 1-Sided *5-9*
 2-Sided > 2-Sided *5-9*
 4in1/8in1 *5-11*

A

Access *4-9*
 Accessibility *4-13*
 Account Name *4-10, 7-31*
 Account Track *7-28*
 Account Track Counter *7-34*
 Account Track Input Method *7-28*
 Account Track Registration *7-33*
 Account Track Settings *7-33*
 Administrative Settings *7-30*
 Administrator Password *7-46*
 Administrator Registration *7-25*
 Administrator Security Levels *7-47*
 Administrator Settings *4-7, 7-3*
 Administrator/Machine Settings *7-25*
 AE Level Adjustment *6-4, 7-10*
 All Jobs *5-64*
 Application *5-22*
 Apply Stamps *7-55*
 Authentication Device Settings *7-37*
 Auto *5-8*
 Auto Booklet ON when Fold & Staple *6-9*
 Auto Color *5-5*
 Auto Color Level Adjust. *6-4*
 Auto Detect *5-37*
 Auto Paper Select for Small Original *6-5*
 Auto Reset *7-19*
 Auto Reset Confirmation *4-14*
 Auto Rotate OFF *5-15*
 Auto Sort/Group Selection *6-9*
 Auto Tray Selection Settings *6-4*
 Auto Tray Switch ON/OFF *6-4*
 Auto Zoom (ADF) *6-9, 7-40*
 Auto Zoom (Platen) *6-9, 7-40*
 Auto Zoom for Combine/Booklet *6-9*
 Automatic Image Rotation *6-10, 7-40*

B

Back (Blank) *5-24*
 Back (Copy) *5-24*
 Background Color *5-32*
 Background Removal *5-20*
 Banner Printing *4-7*
 Basic *5-4*

Binding Position *5-10, 5-16, 5-36*
 Bio Authentication *7-37*
 Black *5-5*
 Blank *5-25*
 Blank Page Print Settings *6-5, 7-22*
 Blue *5-33*
 Book Copy *5-35*
 Book Copy/Repeat *5-35*
 Book Spread *5-35*
 Booklet *5-43*
 Booklet Original *5-39*
 Bottom *5-44*
 Brightness *5-33*
 Bypass Tray *5-6*

C

C (Clear) *4-18*
 Card Authentication *7-37*
 Card Shot *5-60*
 Card Shot Setting *6-10, 7-40*
 Cellular Phone/PDA Setting *7-45*
 Center Erase *5-36*
 Center Staple & Fold *5-43*
 Center Staple Position *7-14*
 Center Zoom *5-42*
 Centering *5-42, 7-13*
 Centering (Duplex 2nd Side) *7-13*
 Change E-Mail Address *6-14*
 Change Icon *6-15*
 Change Password *6-13*
 Change Setting *4-21*
 Change Size *5-7*
 Change Tray Settings *5-6*
 Chapter Paper *5-28*
 Chapters *5-27*
 Check Consumable Life *4-7*
 Check Details *5-62*
 Check Job *4-8, 5-62, 5-65*
 Check Job Set. *5-64*
 Check/Change Temporarily *5-55*
 Color *5-5, 5-57*
 Color Adjustment *5-33*
 Color Balance *5-33*
 Color Registration Adjust *7-11, 7-16*
 Color Selection Settings *6-7*
 Composition *5-58*
 Confidential Document Access Method *7-49*
 Consumables Replace/Processing Procedure *4-17*
 Contrast *5-33*
 Copied Paper *5-20*
 Copier Settings *6-7, 6-9, 7-40*
 Copy *4-6, 5-25*
 Copy Density *5-33*
 Copy Guard *5-51, 7-50*

Copy Insert *5-28*
 Copy Program Lock Settings *7-8*
 Copy Protect *5-50*
 Copy Screen *6-7*
 Counter Details *7-32, 7-34*
 Cover Sheet *5-24, 5-44*
 Coverage Rate *8-11*
 Current Jobs *5-64*
 Custom Display Settings *6-7*
 Custom Size *5-7*

D

Date Format *5-47*
 Date Settings *7-7*
 Date/Time *5-46, 5-50, 5-52, 5-53, 5-54*
 Date/Time Settings *7-6*
 Daylight Saving Time *7-6*
 Default Bypass Paper Type Setting *7-23*
 Default Copy Settings *6-9*
 Default Enlarge Display Settings *6-9*
 Default Function Permission *7-30*
 Default Operation Selection *7-30, 7-32*
 Default Tab *6-7*
 Delete *5-62, 5-64*
 Delete Registered Stamp *7-55*
 Delete Saved Copy Program *7-8*
 Deleted Jobs *5-64*
 Density *5-20, 5-57*
 Density Adjustment *7-11*
 Despeckle *5-16*
 Detail *5-64*
 Detail Settings *5-50, 5-52, 5-53, 5-54*
 Display Activity Log *7-49*
 Document Name *5-61*
 Dot Matrix Original *5-20*
 Driver Password Encryption Setting *7-55*
 Duplex/Combine *5-9*

E

Edit Color *5-30*
 Edit Name *4-8*
 E-Mail Address *7-31*
 Enhanced Security Mode *7-51*
 Enlarge Display *4-15*
 Enlarge Display Mode Confirmation *4-14*
 Enlargement Rotation *6-9*
 Enter Power Save Mode *7-4*
 Erase *5-44*
 Erase Adjustment *7-12*
 Expert Adjustment *7-10*
 External Server Settings *7-36*

F

FAX Active Screen *6-7*
 Fax Settings *7-43*
 Fax TX Settings *7-21*
 Fax/Scan *4-6*

Fax/Scan Settings *6-11*
 Feed Cleaning Settings *7-11*
 Finished Jobs *5-64*
 Finisher Adjustment *7-10*
 Finishing *5-12*
 Finishing Program *6-10*
 Fixed Zoom *5-8*
 Fold/Bind *5-13*
 Frame *5-44*
 Frame Erase *5-36, 5-44*
 Front (Blank) *5-24*
 Front (Copy) *5-24*
 Front and Back Cover *5-35*
 Front Cover *5-35*
 Full Color *5-5*
 Full Size *5-8, 5-42*
 Function *4-16*
 Function Management Settings *7-54*
 Function Map *4-16*
 Function Permission *7-31*

G

General Settings *7-27, 7-37*
 Get Request Code *7-56*
 Glossy *5-21*
 Gradation Adjustment *7-11, 7-17*
 Green *5-33*
 Group *5-12*
 Guidance *4-16*

H

Half-Fold *5-43*
 Half-Fold Position *7-15*
 Half-Fold Specification *6-10*
 HDD Settings *7-53*
 Header/Footer *5-55*
 Header/Footer Settings *7-21*
 Hide Personal Information *7-49*
 Hide Personal Information (MIB) *7-49, 7-50*
 Hue *5-33*

I

Icon *7-32*
 ID & Print Operation Settings *7-30*
 ID & Print Settings *7-30*
 Image Adjust *5-41*
 Image Repeat *5-37*
 Image Shift *5-41*
 Image Size *5-38*
 Image Stabilization *7-11*
 Image Stabilization Only *7-11*
 Image Stabilization Setting *7-11*
 Increase Priority *5-64*
 Initialize *7-49*
 Input Machine Address *7-25*
 Insert Image *5-26*
 Insert Paper *5-25*

Insert Sheet *5-25*
 Insert Sheet Setting *5-48*
 Install License *7-56*
 Interleave Paper *5-23*
 Interrupt *4-5*

J

Job Details *5-62*
 Job History *5-64*
 Job History Thumbnail Display *7-50*
 Job List *5-62, 5-63*
 Job Log Settings *7-49*
 Job Reset *7-19*

K

Key Repeat Start/Interval Time *4-14*

L

Language Selection *6-4*
 Layout *5-60*
 Leading Edge Adjustment *7-13*
 Leading Edge Adjustment (Duplex Side 2) *7-13*
 Left *5-44*
 Left Bind *5-43*
 Left Panel Display Default *6-8*
 License Settings *7-56*
 Limiting Access to Destinations *7-36*
 Line Detection *7-11*
 List/Counter *7-18*
 Login *4-10*
 Logoff Settings *7-37*
 Logout Confirmation Screen Display Setting *7-38*
 Low Power *7-4*
 Low Power Mode Settings *7-4*

M

Management List *7-18*
 Manual *5-8*
 Manual Destination Input *7-49*
 Map *5-20*
 Margin Position *5-41*
 Max. Allowance Set *7-31, 7-33*
 Measurement Unit Settings *6-4*
 Media Adjustment *7-14*
 Message Display Time *4-14*
 Meter Count *8-11*
 Minimal *5-8*
 Mirror Image *5-31*
 Mixed Original *5-16*
 Mode Memory *4-8*

N

Name and Function of Parts *4-16*
 Neg./Pos. Reverse *5-30*
 Network Function Usage Settings *7-54*
 Network Settings *7-39*
 No Matching Paper in Tray Setting *6-4*
 None *5-44*

Non-Image Area Erase *5-45*
 Non-Image Area Erase Operation Settings *7-12*
 Number of User Counters Assigned *7-28*

O

Offset *5-13*
 OHP Interleave *5-23*
 ON (External Server) *7-28*
 ON (MFP) *7-28*
 One-Touch/User Box Registration *4-7, 7-26*
 OpenAPI Authentication Management Settings *7-57*
 OpenAPI Settings *7-44*
 Original Setting *5-16*
 Original Type *5-20*
 Other *5-50, 5-52, 5-53, 5-54*
 Other Functions *4-16*
 Output Permission *7-31, 7-33*
 Output Settings *6-4, 7-5*
 Output Tray Settings *7-5*
 Overlay *5-57*

P

P --- *5-25, 5-26, 5-28*
 Page Margin *5-40*
 Page Number *5-47*
 Page Number Print Position *6-5, 7-24*
 Page Number Type *5-48*
 Page Rotation *4-20*
 Pages *5-47, 5-49, 5-57, 5-59*
 Paper *5-6, 5-24*
 Paper Alignment Plate Settings *7-16*
 Paper Separation Adjustment *7-11*
 Paper Size *5-38*
 Paper Size/Type Counter *7-18*
 Paper Tray Settings *6-4*
 Password *4-10, 7-31*
 Password Copy *5-52, 7-50*
 Password for Non-Business Hours *7-8*
 Password Rules *7-48*
 Pause *7-32, 7-34*
 Photo *5-20*
 Position *5-51, 5-54*
 Position Setting *5-13*
 Poster Mode *5-38*
 Power Save *4-12*
 Power Save Key *7-4*
 Power Save Settings *6-4, 7-4*
 Prefix/Suffix Automatic Setting *7-45*
 Preset Stamp *5-50, 5-52, 5-53, 5-54*
 Print *5-63*
 Print Counter List *7-35*
 Print Data Capture *7-49*
 Print Jobs During Copy Operation *6-10, 7-40*
 Print Lists *6-4*
 Print Position *5-47, 5-48, 5-49*
 Print without Authentication *7-35*

Print/Fax Output Settings 7-5
 Printer Adjustment 7-10
 Printer Information 7-45
 Printer Settings 6-12, 7-42
 Prior Detection Setting 7-11
 Program Jobs 5-28
 Prohibited Functions When Authentication Error 7-49
 Proof Copy 4-19
 Public User Access 4-10, 7-28
 Punch 5-13
 Punch Horizontal Position Adjustment 7-15
 Punch Regist Loop Size Adjustment 7-16

Q

Quality/Density 5-19
 Quick Setting 1 6-7
 Quick Setting 2 6-7
 Quick Setting 3 6-7
 Quick Setting 4 6-7

R

Recall Header/Footer 5-55
 Recall Overlay Image 5-59
 Receive 5-63
 Red 5-33
 Register Auth. Info. 7-31
 Register Authentication Information 6-16
 Register Overlay Image 5-59
 Register Program 4-8
 Registered Overlay 5-58
 Registered Stamp 5-50, 5-54
 Release Held Job 5-64
 Reset 4-5, 5-55
 Reset All Counters 7-32, 7-34
 Reset Settings 7-19
 Restrict Access to Job Settings 7-9
 Restrict Fax TX 7-49
 Restrict Operation 7-9
 Restrict User Access 7-8
 Right 5-44
 Right Bind 5-43

S

Saturation 5-33
 Save 5-63
 Save & Print 5-61
 Save in User Box 5-61
 Scan to Authorized Folder Settings 7-38
 Scan to Home Settings 7-38
 Scan/Fax Settings 6-7
 Search by Operation 4-16
 Search Option Settings 6-8
 Secure Print Only 7-50
 Security Details 7-48
 Security Settings 7-46
 Select Color 5-32

Select Keyboard 6-5
 Select Time for Power Save 7-8
 Select Tray for Insert Sheet 6-9, 7-40
 Send 5-63
 Separate Scan 5-14
 Separate Scan Output Method 6-9
 Separation 5-35
 Server Name 4-10
 Service/Admin. Information 4-16
 Set Range 5-37
 Sharpness 5-33
 Sheet/Cover/Chapter Insert 5-23
 Shift Output Each Job 7-5
 Shortcut Key 1 6-7
 Shortcut Key 2 6-7
 Single Color 5-5
 Single Color > 2 Color Output Management 7-38
 Skip Job Operation Settings 7-22
 Sleep 7-4
 Sleep Mode Settings 7-4
 Sort 5-12, 5-25, 5-26, 5-28
 Sound Setting 4-14
 Specify Default Tray when APS Off 6-9, 7-40
 Stamp 5-49
 Stamp Repeat 5-53
 Stamp Settings 7-21, 7-55
 Stamp Type/Presets 5-49
 Stamp/Composition 5-46
 Staple 5-13
 Start 4-5
 Starting Chapter Number 5-48
 Starting Page Number 5-48
 Stop 4-5
 Store 5-7
 Synchronize User Authentication & Account Track 7-28
 System Auto Reset 7-19
 System Auto Reset Confirmation 4-14
 System Connection 7-44
 System Settings 6-4, 7-4

T

Text 5-20
 Text Color 5-49, 5-56
 Text Details 5-47, 5-48
 Text Enhancement 5-21
 Text Size 5-49
 Text/Photo 5-20
 Ticket Hold Time Setting 7-28
 Time Format 5-47
 Time Settings 7-7
 Time Zone 7-6
 Top 5-44
 Touch Panel Adjustment 4-13
 Transparency 5-23
 Tray 1 5-6

Tray 2 *5-6*

Tray 3 *5-6*

Tray 4 *5-6*

U

User Authentication *7-28*

User Authentication Settings *7-30*

User Authentication/Account Track *7-27*

User Box *4-6, 5-61*

User Box Administrator Setting *7-46*

User Box Settings *6-7, 7-20*

User Counter *7-32*

User Name *4-10, 7-31*

User Name List *4-10, 7-30*

User Preset Zoom *5-8*

User Registration *7-31, 7-32*

User Settings *4-7, 6-3*

User/Account Common Setting *7-38*

Utility/Counter *4-7*

V

View Finishing *4-21*

View Pages *4-21*

View Status *4-21*

W

Watermark *5-56*

Watermark Type *5-56*

Weekly Timer ON/OFF Settings *7-7*

Weekly Timer Settings *7-7*

When # of Jobs Reach Maximum *7-28, 7-29*

When AMS Direction is Incorrect *6-9*

Wide Paper *5-7*

With Margin *5-37*

Without Margin *5-37*

X

X/Y *5-7*

Z

Z-Folded Original *5-16*

Zoom *4-20, 5-8, 5-38, 5-60*

DIRECTIVE 2002/96/CE ON THE TREATMENT, COLLECTION, RECYCLING AND DISPOSAL OF ELECTRIC AND ELECTRONIC DEVICES AND THEIR COMPONENTS

INFORMATION

1. FOR COUNTRIES IN THE EUROPEAN UNION (EU)

The disposal of electric and electronic devices as solid urban waste is strictly prohibited: it must be collected separately.

The dumping of these devices at unequipped and unauthorized places may have hazardous effects on health and the environment.

Offenders will be subjected to the penalties and measures laid down by the law.

TO DISPOSE OF OUR DEVICES CORRECTLY:

- a) Contact the Local Authorities, who will give you the practical information you need and the instructions for handling the waste correctly, for example: location and times of the waste collection centres, etc.
- b) When you purchase a new device of ours, give a used device similar to the one purchased to our dealer for disposal.



The crossed dustbin symbol on the device means that:

- when it to be disposed of, the device is to be taken to the equipped waste collection centres and is to be handled separately from urban waste;
- The producer guarantees the activation of the treatment, collection, recycling and disposal procedures in accordance with Directive 2002/96/CE (and subsequent amendments).

2. FOR OTHER COUNTRIES (NOT IN THE EU)

The treatment, collection, recycling and disposal of electric and electronic devices will be carried out in accordance with the laws in force in the country in question.